

REPORT TO THE COLORADO GENERAL ASSEMBLY

THE EXECUTIVE AND LEGISLATIVE BRANCHES OF COLORADO STATE GOVERNMENT: FUNCTIONS, FUNDING, AND FTE

Law Lib.
KFC
1820
.L4
no. 285

Colorado Legislative Council Research Publication No. 285
March, 1984

200-10
100
100
100
100
100
100
100
100
100

REPORT TO THE COLORADO GENERAL ASSEMBLY:
///

THE EXECUTIVE AND LEGISLATIVE BRANCHES
OF COLORADO STATE GOVERNMENT: FUNCTIONS,
FUNDINGS, AND FULL-TIME EMPLOYEES

COLORADO LEGISLATIVE COUNCIL
RESEARCH PUBLICATION NO. 285
March 30, 1984

March 30, 1984

To Members of the Fifty-fourth Colorado General Assembly:

House Joint Resolution No. 1016, adopted during the 1981 session of the General Assembly, directed the Speaker of the House of Representatives and the President of the Senate to appoint a special committee for the purpose of compiling a list of "all functions performed by state government in Colorado, determine the statutory or other authorization for such functions, and determine the costs of these functions". The resolution provided for eleven members, six members from the House of Representatives, to be appointed by the Speaker, and five members from the Senate, to be appointed by the President. The resolution also specified that the committee elect its own chairman and vice-chairman.

The following members of the General Assembly were appointed to the committee known as the Legislative Program Priority Committee:

Senator Regis Groff	Representative Bill Artist
Senator Don MacManus	Representative Don Mielke
Senator Dan Noble	Representative Frank Randall
Senator Dan Schaefer	Representative Jim Robb
Senator Ruth Stockton	Representative David Skaggs
	Representative Wilma Webb

Senator Dan Schaefer was elected chairman for the first year of the study with Representative Robb serving as vice-chairman. For the second year Representative Robb was chairman and Senator Schaefer was vice-chairman.

During the summer and fall of 1981, the committee developed a format to be followed by the departments of the executive branch as they assisted the committee staff in compiling information for the study. A format for the report was also determined. The committee

March 30, 1984

Page iv

envisioned a detailed guide or handbook of the functions performed by the executive branch of state government for use by legislators, executive agency personnel, local officials, and other citizens. It was hoped that the study would assist the General Assembly in identifying the following: programs not authorized by statute; programs authorized by statute but not funded; and duplications between programs administered by state agencies and other governmental entities.

The committee decided that the handbook should be divided into two sections, the first section to contain a listing of functions organized by department. A second section would be devoted to organization charts and budget data for each of the twenty departments within the executive branch. A general index would give access to the entire document.

During the month of December, 1981, the committee sent a letter to each of the executive department directors asking for their assistance in compiling information needed for the handbook. The directors were asked to submit the information to the committee by April, 1982.

By late fall of 1982 it became clear that not all of the departments were able to comply in a timely manner with the committee's request. As a result, a preliminary report was published in January, 1983. Submissions from the five remaining departments were made during 1983. The committee was not reestablished in 1983; instead, the Legislative Council staff assumed responsibility for completing the report.

I want to express my appreciation to the twenty departments for their information and assistance. In several cases, hundreds of hours were spent by department personnel on the committee's assignment. Special recognition for careful and timely compliance is given to the following departments: Agriculture, Education, Highways, Natural Resources, and Revenue. Appreciation is also expressed to the Department of Administration for assistance in developing a format for the handbook.

The detailed listing of functions performed by the executive and legislative branches of Colorado state government together with a determination of the costs of those functions and an identification of their statutory authorization has not been accomplished in recent memory. It has been a very large task. There may be inadvertent

March 30, 1984

Page v

errors and omissions in the accompanying report. The executive departments or agencies within the legislative branch did not comply uniformly. I regret that the judicial branch is not included in this report. Experience may show that a better format could have been devised. I share the committee's desire, however, that the handbook be a first step in assisting those wanting to know more about Colorado state government.

Very truly yours,

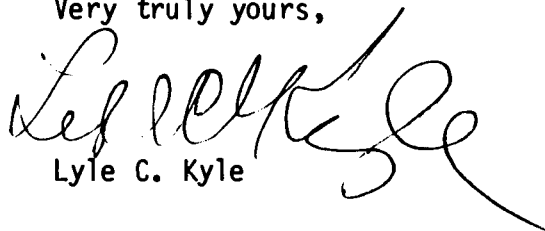
A handwritten signature in cursive script, appearing to read "Lyle C. Kyle". The signature is written in black ink and is positioned above the printed name.

Lyle C. Kyle

TABLE OF CONTENTS

	<u>Page</u>
LETTER OF TRANSMITTAL.....	iii
TABLE OF CONTENTS.....	vii
FOREWORD.....	ix
DEPARTMENTS	
Administration.....	AD-1-24
Agriculture.....	AG-1-18
Corrections.....	CO-1-18
Education.....	ED-1-18
Health.....	HEA-1-23
Higher Education.....	HE-1-18
Highways.....	HI-1-35
Institutions.....	IN-1-10
Labor and Employment.....	LE-1-17
Law.....	L-1-15
Legislative Branch.....	LEG-1-15
Local Affairs.....	LA-1-24
Military Affairs.....	MA-1-9
Natural Resources.....	NR-1-41
Personnel.....	PER-1-6
Regulatory Agencies.....	RA-1-53
Revenue.....	REV-1-24
Social Services.....	SS-1-25
State.....	ST-1-11
State Planning and Budgeting.....	OSPB-1-5
Treasury.....	TR-1-3
Index.....	1-31

FOREWORD

In seeking a greater understanding of the activities of the executive branch of Colorado state government, the Committee on Legislative Program Priority asked the directors of each of the twenty executive departments to list the functions assigned to or performed by their agencies as well as identify the state statute, federal law, rule or regulation, administrative decree, or executive order authorizing the activity. After receiving the lists of functions from the departments (usually arranged according to organizational unit), the committee staff grouped the duties within broad functional categories.

With regards to the department's organizational charts, with a few exceptions, a detailed picture of each department's structure was provided by the departments. The following is a legend to the symbols used in drawing the department organization charts.

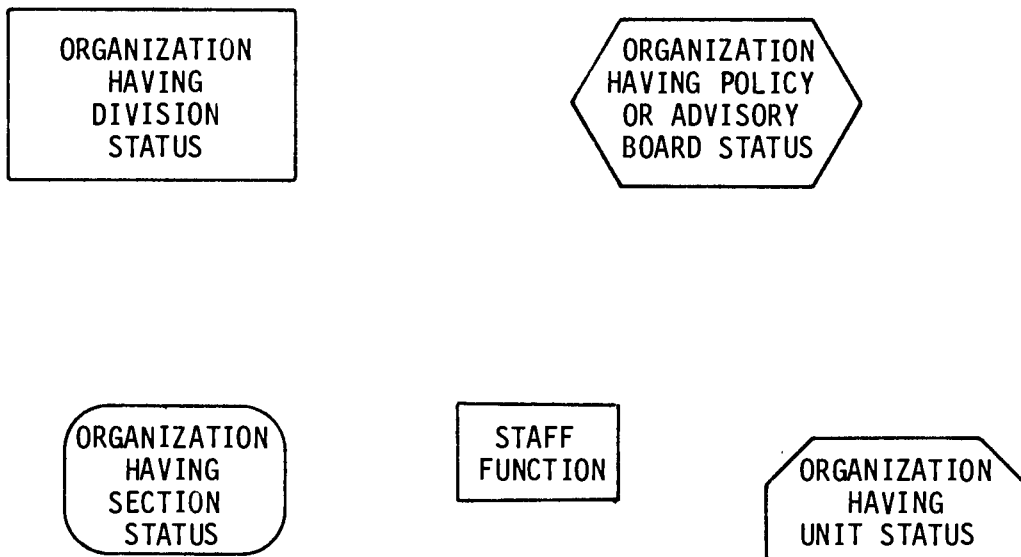

The designations conform to the organizational terminology found in the state statutes. The Administrative Organization Act of 1968 prescribes the general organizational terminology and structure of the executive branch by directing that powers, duties, and functions of the principal departments be allocated to divisions, sections, and units within the departments. Although the statutes do not define "division", "section", "unit", or "staff", these terms are generally recognized as representing a hierarchy of organizational entities with "division" being the highest or broadest organizational entity within

a department. Divisions are made up of sections, units and staff agencies. All departments and most divisions are named in the statute; specific sections, units and staff agencies within the principal departments are not generally identified in the law. Divisions are made up of sections and sections usually contain a number of units. A unit is the smallest or lowest organizational entity within a department. A staff function often assists a department or division director.

Under most of the organizational boxes drawn for the major organizational units within a department, the reader will find a number and an "a", "b" or "c" alphabetical designation. The numerical designation identifies the functions (listed in the pages preceding the charts) performed by the organizational entity. The "a" "b" "c" alphabetical designations describe the approximate contribution that the agency makes to carrying out the function preceding the letter designation.

a = 75 to 100% contribution
b = 25 to 75% contribution
c = 5 to 25% contribution

The heads or directors of each division within a department are assumed to bear the responsibility for a part of each of their divisions functions. Therefore, unless the division director personally assumes nearly all of the responsibility for a given function to the exclusion of significant staff contributions, no notation of the function number is made under the organizational symbol for the division director's office.

FTE figures for each agency and funding sources for each agency are also delineated. They represent figures for the fiscal year 1982. Dollar figures are in thousands. Funding sources are indicated by the following designations:

C = cash funding
F = federal funding
G = general funding
HUTF = highway users tax fund

An illustration of how the symbols explained in the preceding paragraphs have been used in the report may be helpful to the reader. One of the first principal departments found in the report is the Department of Agriculture. Pages AG-1 through AG-9 provide a listing of the major duties performed by the department. The duties are listed under major headings. The headings describe the general activities performed by the department. Pages AG-10 through AG-18 detail the organization chart for the department. Page AG-10 provides an overview of the department, showing divisions, sections and units. In the top left hand corner of AG-10 are the funding totals for the department for FY 1981-82: \$5,823,000 from the state's general fund, \$5,543,000 from cash funds and \$104,000 from federal sources. The

pages following AG-10 detail the internal structures of each of the organizational entities found on AG-10. For example, the organization box at the top of the chart on page AG-10 -- identified as Executive Director -- is detailed further on AG-11.

The pattern described above is repeated for each of the departments contained in the report.

The individuals listed below were responsible for the submission of information to the committee staff.

<u>Department</u>	<u>Coordinator</u>	<u>Phone</u>
Administration	Al Levine	866-3221
Agriculture	John Martinez	866-4069
Corrections	Rocky Wells	275-4181
Education	Pat Burger	866-2265
General Assembly	David Hite	866-3521
Health	Don Rice	320-8333
Higher Education	Pam Wagner	866-4034
Highways	Bruce Nilemo	757-9705
Institutions	Dwight Eisnach	761-0220
Labor and Employment	Ellen Ostby	866-6519
Law	Richard Kaufman	866-3611
Local Affairs	Mickey Crist	866-2771
Military Affairs	Paul Parsons	777-8669
Natural Resources	Ruth Woods	866-3311
Personnel	Debbie Wagner	866-2321
Regulatory Agencies	Sue Malloy	866-3997
Revenue	Marty Hartman	866-3554
Social Services	Bob Husson	866-2511
State	Jim Manuel	866-2761
State Planning & Budgeting	Les Schoenfeld	866-3386
Treasury	Marcy Dill	866-2441

DEPARTMENT OF ADMINISTRATION

Provides Centralized Administrative Services to Executive Departments

	<u>Page</u>
Automated Data Processing.....	AD-1
ADP Services.....	AD-1
Statewide Planning.....	AD-1
Statewide Supervision.....	AD-1
Communications Systems.....	AD-2
Hearings.....	AD-2
Minority Affairs.....	AD-2
Public Records.....	AD-3
Custodial Duties.....	AD-3
State Buildings.....	AD-3
Capital Construction.....	AD-3
Housekeeping.....	AD-4
Inventory of Property.....	AD-4
Leases.....	AD-4
Maintenance.....	AD-5
Master Plans.....	AD-5
Parking.....	AD-5
Security.....	AD-5
State Employees.....	AD-5
Support Services.....	AD-6

Provides Centralized Financial Services to Executive Departments

Accounting.....	AD-6
Appropriations.....	AD-7
Transfers.....	AD-7
Audit.....	AD-7
Claims.....	AD-7
Financial Affairs.....	AD-7
State Government Operations.....	AD-7
Fiscal Rules.....	AD-8

	<u>Page</u>
Purchasing.....	AD-8
Contracts.....	AD-8
Motor Vehicles.....	AD-8
Printing.....	AD-8
Supplies Management.....	AD-9

Provides Centralized Management Services to Executive Departments

Management Consulting.....	AD-9
----------------------------	------

Provides Internal Support Services for the Department of Administration

Accounting, Budgets, Payroll and Quality Control.....	AD-9
---	------

DEPARTMENT OF ADMINISTRATION

Provides Centralized Administrative Services to Executive Departments

Automated Data Processing

Automated Data Processing Services

1. Establishes and maintains automated data processing facilities including, but not limited to, the operation of automated data processing (ADP) equipment and facilities and the employment of needed personnel. (General Government Computer Center; 24-30-603, C.R.S. 1973)
2. Provides ADP systems development, services, equipment, facilities and maintenance for state departments, institutions and agencies. (General Government Computer Center; 24-30-603, C.R.S. 1973)
3. Provides ADP system software services for users of equipment and facilities. (General Government Computer Center, Technical Support Section; 24-30-603, C.R.S. 1973)
4. Meets with computer users to discuss computer problems. (General Government Computer Center, User Advisory Council; no statutory authorization)

Statewide Planning

5. Formulates a current and long-range ADP plan for state government and establishes priorities. (Division of Automated Data Processing; 24-30-603, C.R.S. 1973)

Statewide Supervision

6. Approves or disapproves the acquisition of ADP equipment by any agency; approves, disapproves or modifies ADP staffing patterns. (Division of Automated Data Processing; 24-30-603, C.R.S. 1973)
7. Prescribes standards governing the selection and operation of ADP equipment. (Division of Automated Data Processing; 24-30-604, C.R.S. 1973)
8. Conducts a continuing reassessment and study of the ADP needs of state agencies. (Division of Automated Data Processing, Evaluation Section; 24-30-603, C.R.S. 1973)

9. Administers the current approved and long range plans and exercises general supervision over all ADP applications, communication systems, programs, personnel, equipment and facilities. (~~Division of Automated Data Processing; 24-30-603, C.R.S. 1973~~)
10. Establishes ADP procedures and standards for management of ADP facilities for state agencies. (Division of Automated Data Processing; 24-30-603, C.R.S. 1973)

~~Communications Systems~~^{ems}

11. Prepares and administers current and long range communication plans involving telephone, radio, microwave television, and ADP communication systems. (Division of Communications, Planning and Development Section; 24-30-903, C.R.S. 1973)
12. Maintains the state's communications system and associated equipment including towers and antennas. (Division of Communications Engineering, and Technical Staff; 24-30-903, C.R.S. 1973)
13. Advises the governor and general assembly on communication matters. (Division of Communications; 24-30-903, C.R.S. 1973)
14. Advises and consults on policy and technical matters relative to a plan for a total state communications system. (Division of Communications, Advisory Committee; 24-30-904, C.R.S. 1973)

Hearings

15. Conducts administrative and disciplinary hearings for the agencies within the executive branch. (Division of Hearing Officers; 24-30-1001, C.R.S. 1973)

Minority Affairs

16. Encourages and stimulates state agencies to do business with minority businesses. (Colorado Minority Business Development Agency; Executive Order, May 22, 1980)
17. Maintains a record of project goals and achievement for each department. (Colorado Minority Business Development Agency, Technical Assistance Section; Executive Order, May 22, 1980)

Public Records

Custodial Duties

18. Assures reasonable access to records for purposes of historical reference, research and information. (Division of Archives and Public Records, Research Services Section; 24-80-102, C.R.S. 1973)
19. Serves as the official custodian and trustee of all public records transferred from any public office of the state or any political subdivision. (Division of Archives and Public Records; 24-80-102 and 24-80-104, C.R.S. 1973)
20. Determines whether records are of legal, administrative or historical value in consultation with the custodian and the attorney general. (Division of Archives and Public Records, State Archivist; 24-80-103, C.R.S. 1973)
21. Formulates such programs as are necessary for the conservation of the records of the state or any subdivision. (Division of Archives and Public Records, State Archivist; 24-80-102 and 24-80-104, C.R.S. 1973)
22. Takes custody of the property of the state when no other provision is made. (Division of Archives and Public Records, State Archivist; 24-80-102.5, C.R.S. 1973)

State Buildings

Capital Construction

23. Ensures that nine percent of the gross amount spent on state construction is awarded to minority businesses. (Colorado Minority Business Development Agency; Executive Order, May 22, 1980)
24. Supervises and is responsible for the expenditure of funds appropriated for capital construction projects and controlled maintenance projects at the institutions and agencies of the state. (State Buildings Division, Project Administration Unit; 24-30-1303 (1) (d), C.R.S. 1973)
25. Develops standards relating to space, to architectural, structural, mechanical and electrical systems and to energy conservation which shall be the basis for approving facilities, master plans, facility program plans, schematic designs, design development phases and construction documents. (State Buildings Division; 24-30-1303 (1)(h), C.R.S. 1973)

26. Develops a construction procedures manual for state facilities and state-assisted facilities. (State Buildings Division; 24-30-1303 (1) (i), C.R.S. 1973)
27. Develops standards of inspection for monitoring construction projects. (State Buildings Division, Project Administration Section; 24-30-1303 (1) (j), C.R.S. 1973)
28. Maintains approved lists of qualified architects, engineers, landscape architects, land surveyors and consultants from which the principal representative shall make a selection. (State Buildings Division, Contracts Unit; 24-30-1303 (1) (p), C.R.S. 1973)
29. Develops and maintains approved lists of qualified contractors to bid on construction projects. (State Buildings Division, Contracts Unit; 24-30-1303 (1) (q), C.R.S. 1973)
30. Reviews facility program plans, schematic designs, and design development and construction documents for compliance with approved construction standards and with the appropriation, and reviews cost estimates prior to authorizing the calling of bids. (State Buildings Division; 24-30-1303 (1) (r), C.R.S. 1973)
31. Enforces construction standards for the use of state buildings by the handicapped. (State Buildings Division, Facilities Planning Section; 24-30-1303 (1) (v), C.R.S. 1973)

Housekeeping

32. Maintains buildings in the capitol complex. (Housekeeping and Grounds Section; 24-30-102 (1) (h), C.R.S. 1973)

Inventory of Property

33. Maintains a current inventory of all state owned real property. (State Buildings Division, Real Estate/Contracts Section; 24-30-1303, C.R.S. 1973)

Leases

34. Negotiates and executes leases on behalf of the state for land, buildings and offices. (State Buildings Division, Real Estate Unit; 24-30-1303, C.R.S. 1973)

Maintenance

35. Provides preventative and corrective maintenance to all the buildings and equipment of the capitol complex. (Physical Plant Maintenance Section; 24-30-102 (1) (h), C.R.S. 1973)
36. Provides utility services, e.g. heating, electricity, air conditioning, plumbing, painting and domestic work to the buildings and grounds of the capitol complex. (Physical Plant Maintenance Section; 24-30-102, C.R.S. 1973)
37. Provides groundskeeping services to the capitol complex. (Housekeeping and Grounds Section, Grounds Maintenance Unit; 24-30-102 (1) (h), C.R.S. 1973)

Master Plans

38. Develops, or causes to be developed, current facilities master plans and facility program plans for each state institution and agency (except higher education). (State Buildings Division, Facilities Planning Section; 24-30-1303, C.R.S. 1973)
39. Develops and maintains life-cycle cost analysis methods for state facilities. (State Buildings Division, Facilities Planning Section; 24-30-1303, C.R.S. 1973)

Parking

40. Operates the parking lots, parking garage and parking meters in the capitol complex. (Housekeeping and Grounds Section, Building Security and Parking Unit; 24-30-102, C.R.S. 1973)
41. Administers parking for the capitol complex. (Administrative Services Section; 24-30-102 (1) (h), C.R.S. 1973)

Security

42. Provides security to state buildings in the capitol complex. (Housekeeping and Grounds Section, Building Security and Parking Unit; 24-30-102, C.R.S. 1973)

State Employees

43. Prescribes administrative procedures for grievances regarding overtime compensation for state employees. (Division of Accounts and Control, State Controller; 24-30-202 and 24-75-203, C.R.S. 1973)

44. Provides administrative, accounting and clerical responsibilities in connection with the State Employees' and Officials' Group Health Insurance Board of Administration. (Division of Accounts and Control, State Employees' and Officials' Group Health Insurance Board of Administration and Processing Section; 10-8-205, C.R.S. 1973)
45. Administers a deferred compensation plan for state employees in addition to any retirement pension, benefit or other deferred compensation plans established by the state or a political subdivision. (Division of Accounts and Control, State Deferred Compensation Committee and Processing Section; 24-52-102, C.R.S. 1973)
46. Directs a program to encourage state employees to develop new ideas for improving the economy and efficiency of state government. (Division of Accounts and Control, Incentive Award Suggestion System Board; 24-30-801, C.R.S. 1973)
47. Authorizes advance payments of funds for state employee travel. (Division of Accounts and Control, State Controller; 24-30-202 and 24-75-203, C.R.S. 1973)

Support Services

48. Provides general support services, such as printing, microfilming, mail rooms, storerooms and motor pool for state agencies in Adams, Arapahoe, Denver and Jefferson counties. (Division of Central Services; 24-30-1101 and 24-30-1104, C.R.S. 1973)
49. Establishes techniques and standards for microfilm and evidentiary certification of photographs, microphotographs or reproductions. (Division of Central Services, Printing Plant Section; 24-30-1104, C.R.S. 1973)

Provides Centralized Financial Services to Executive Departments

Accounting

50. Performs all centralized accounting for the state. (Division of Accounts and Control, Reporting and Analysis Section, ADP Systems Unit; 24-30-201, C.R.S. 1973)
51. Maintains lists of sources from which moneys accrue to the state. (Division of Accounts and Control, Contracts and Vouchers Unit and Payroll and Warrant Control Unit; 24-30-202 and 24-75-203, C.R.S. 1973)

Appropriations

52. Approves expenditure of anticipated appropriations; and authorizes financial advances and loans. (Division of Accounts and Control, Field Controller Section; 24-30-201, C.R.S. 1973)
53. Requires the establishment of reserve funds out of existing appropriations with the approval of the governor. (Division of Accounts and Control, Field Controller Section; 24-30-206, C.R.S. 1973)

Transfers

54. Recommends transfers between appropriations. (Division of Accounts and Control, Deputy State Controller and Field Controller Section; 24-30-201, C.R.S. 1973)

Audit

55. Maintains a current audit of all cash, cash receipts and receivables for the state. Performs pre-audit functions, control obligations and disbursements. (Division of Accounts and Control, Contracts and Vouchers Unit and Payroll and Warrant Control Unit; 24-30-201, C.R.S. 1973)

Claims

56. Issues warrants for the payment of claims against the state. (Division of Accounts and Control, Payroll and Warrant Control Unit; 24-30-201, C.R.S. 1973)

Financial Affairs

State Government Operations

57. Approves financial statements; estimates future revenues and operations. (Division of Accounts and Control, Reporting and Analysis Section; 24-30-201, C.R.S. 1973)
58. Provides for a centralized system of debt collection. (Division of Accounts and Control, Central Debt Collection Unit; 24-30-201, C.R.S. 1973)
59. Manages the finances and financial affairs of the state. (Division of Accounts and Control, State Controller; 24-30-201, C.R.S. 1973)

60. Devises and prescribes procedures for financial administration and control for all state agencies. (Division of Accounts and Control, Field Controller Section; 24-30-201, C.R.S. 1973)
61. Prepares an annual report of the financial operations of all state agencies. (Division of Accounts and Control, Reporting and Analysis Section; 24-30-201, C.R.S. 1973)

Fiscal Rules

62. Promulgates fiscal rules. (Division of Accounts and Control, Deputy State Controller; 24-30-201, C.R.S. 1973)

Purchasing

Contracts

63. Resolves controversies resulting from solicitations or awards of contracts, debarments or suspensions from consideration or breaches of contract. (Division of Purchasing; 24-109-101, C.R.S. 1973)
64. Maintains a registry and file of legislative department contracts. (Division of Purchasing; 2-2-320, C.R.S. 1973)
65. Notifies the attorney general when any person fails to perform the terms required under any contract. (Division of Purchasing; 24-70-218, C.R.S. 1973)

Motor Vehicles

66. Prescribes rules governing the use and maintenance of all state-owned motor vehicles. (Division of Purchasing, Procurement Advisory Council; 24-102-203, C.R.S. 1973)
67. Approves all motor vehicle purchases for the state. (Division of Purchasing; 24-102-203, C.R.S. 1973)

Printing

68. Directs and supervises all public printing. (Division of Purchasing; 24-70-202, C.R.S. 1973)
69. Specifies the type of paper to be used for public printing. (Division of Purchasing; 24-70-212, C.R.S. 1973)

Supplies Management

70. Establishes procedures for and monitors procurement of all supplies and services required by the state except bridge and highway construction, capital construction and controlled maintenance. (Division of Purchasing; 24-30-402, C.R.S. 1973)
71. Disposes of surplus supplies belonging to the state. (Division of Purchasing; 24-30-202, C.R.S. 1973)
72. Prescribes forms to be used by agencies in the requisitioning, ordering and reporting of supplies, services and construction. (Division of Purchasing; 24-102-202, C.R.S. 1973)

Provides Centralized Management Services to Executive Departments

Management Consulting

73. Studies agencies' programs and management in order to identify problems and recommend improvements. (Division of Management Services; 24-30-102, C.R.S. 1973)

Provides Internal Support Services for the Department of Administration

Accounting, Budgets, Payroll and Quality Control

74. Performs departmental accounting and reporting and prepares departmental budgets, payrolls, and billings to other state agencies. (Administrative Services Section; no statutory authorization)
75. Administers an internal quality control program as a means of continually studying and assessing service operations and needs of state departments, institutions and agencies. (Division of Central Services, Quality Assurance Unit; 24-30-1104 (1) (i), C.R.S. 1973)

Department Totals: \$13,030 K-G
 \$10,513 K-C
 \$1,425 K-HUTF
 \$99 K-F
 597 FTE

DEPARTMENT OF ADMINISTRATION

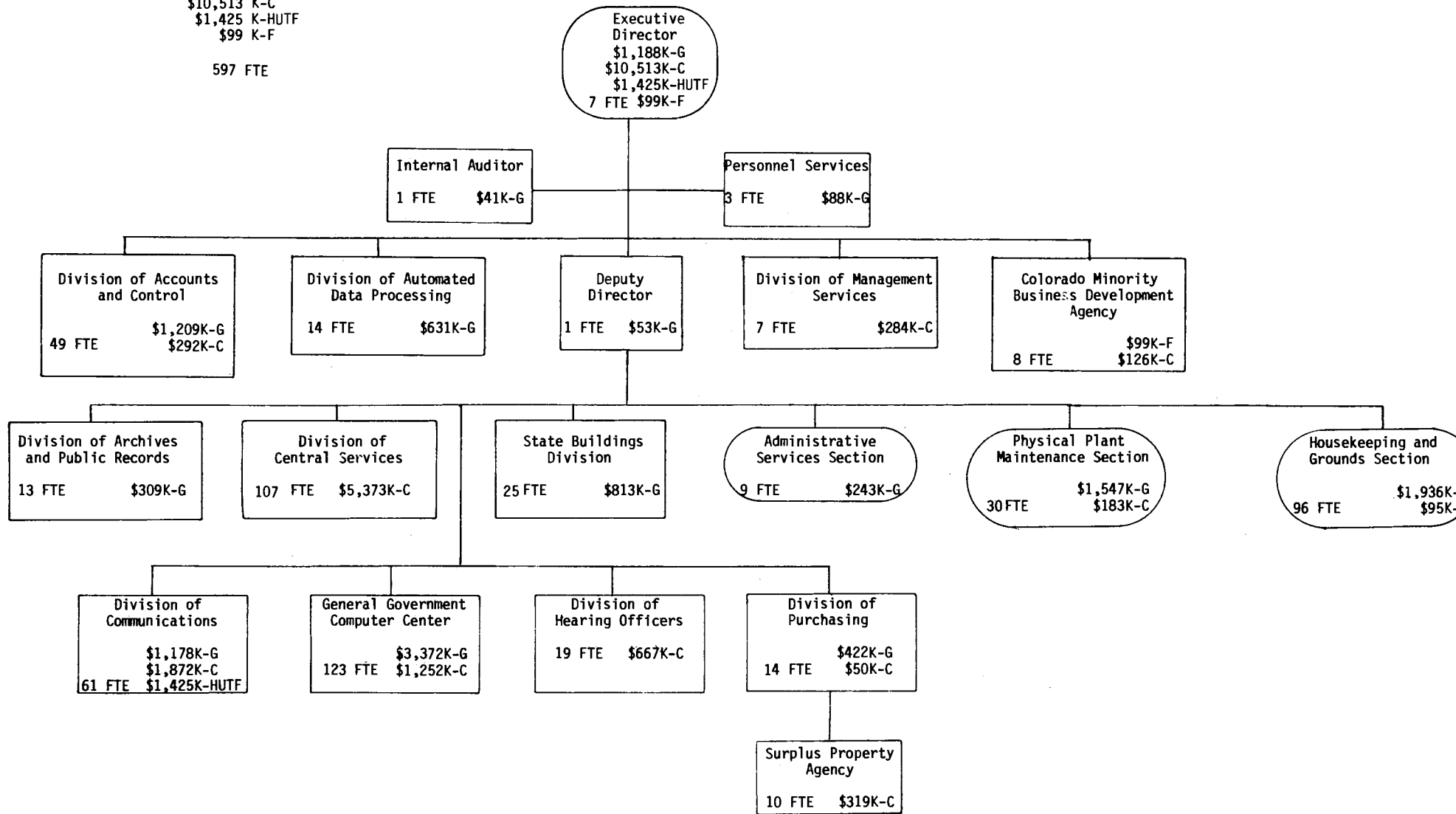

AD-10

Section Totals:

\$144 K-G

9 FTE

ADMINISTRATIVE SERVICES SECTION

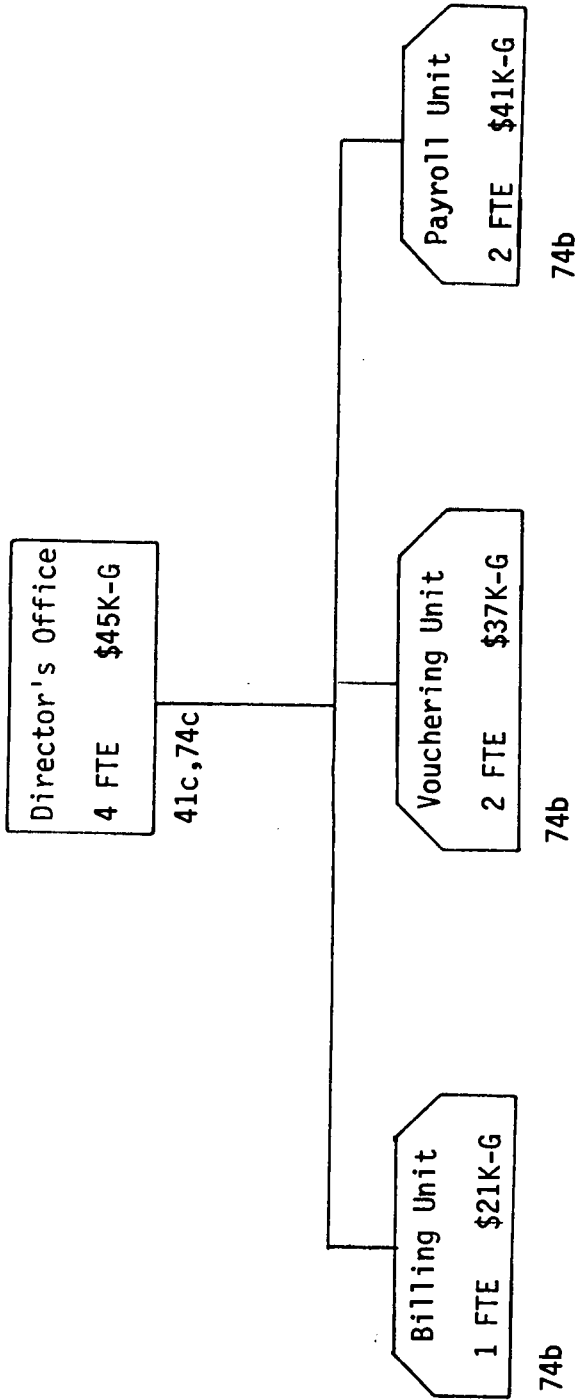

Division Totals:

\$1,209 K-G
\$292 K-C

49 FTE

DIVISION OF ACCOUNTS AND CONTROL

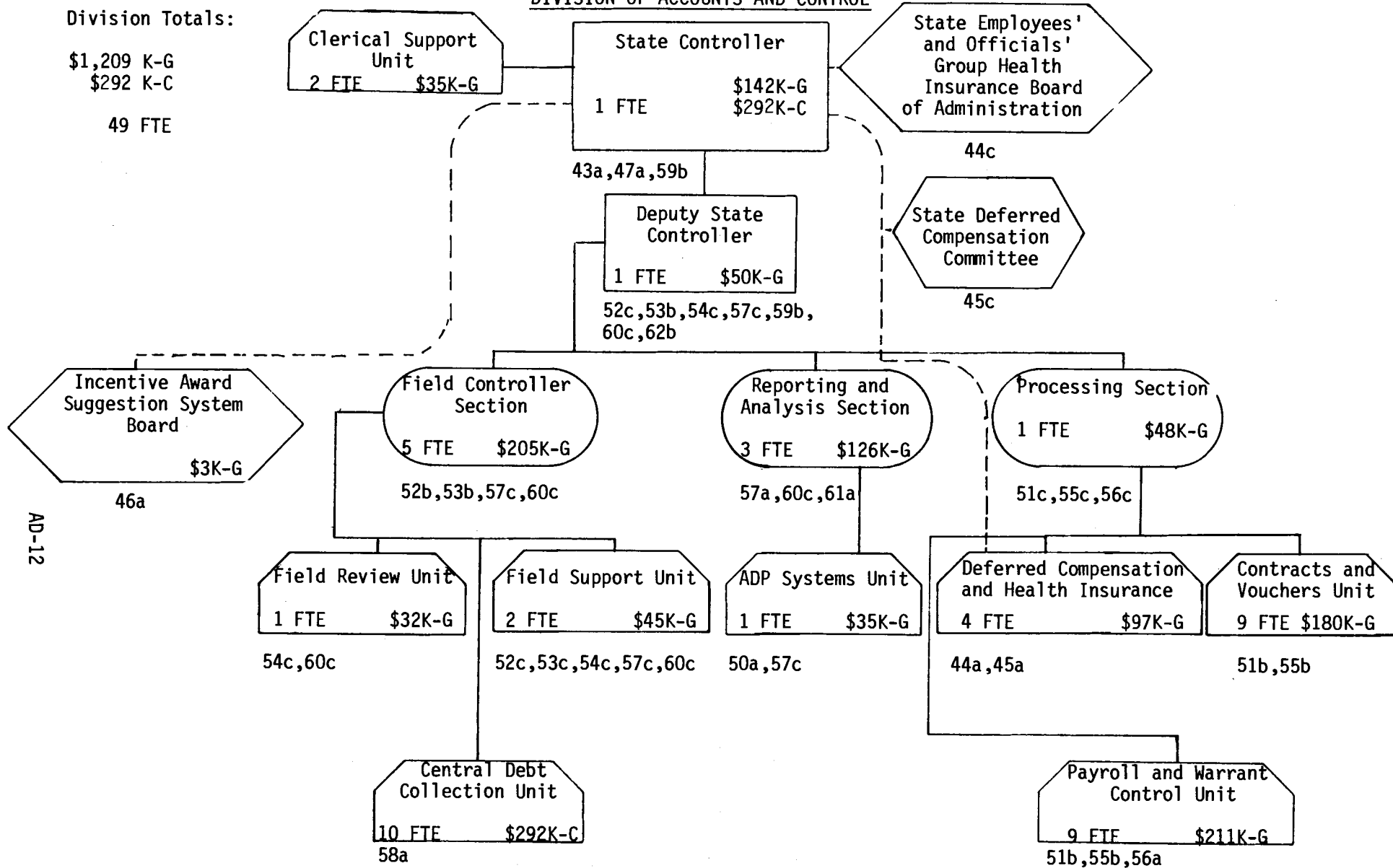

AD-12

Division Totals:

\$309 K-G

13 FTE

DIVISION OF STATE ARCHIVES AND PUBLIC RECORDS

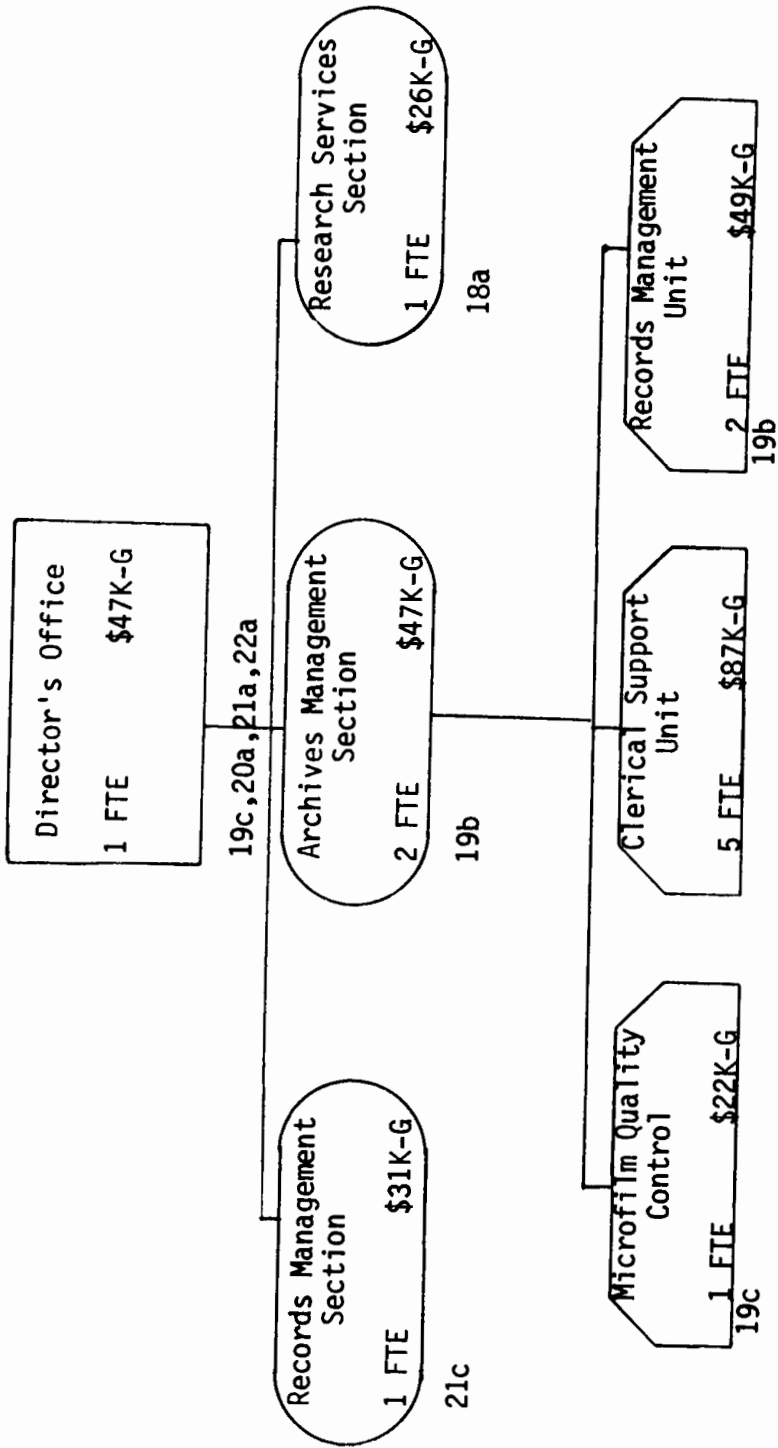

Division Totals:

\$631 K-G

14 FTE

DIVISION OF AUTOMATED DATA PROCESSING

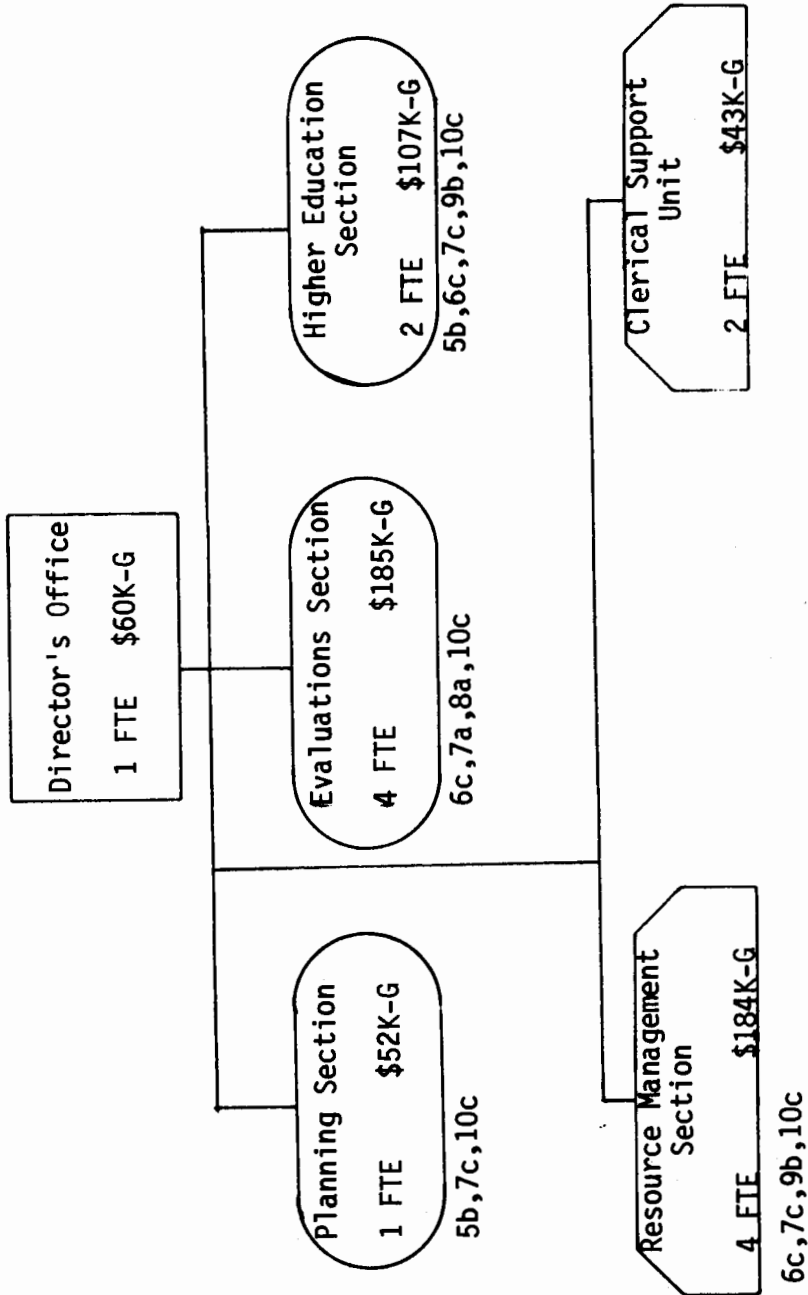

STATE BUILDINGS DIVISION

Division Totals:

\$813 K-G

25 FTE

AD-15

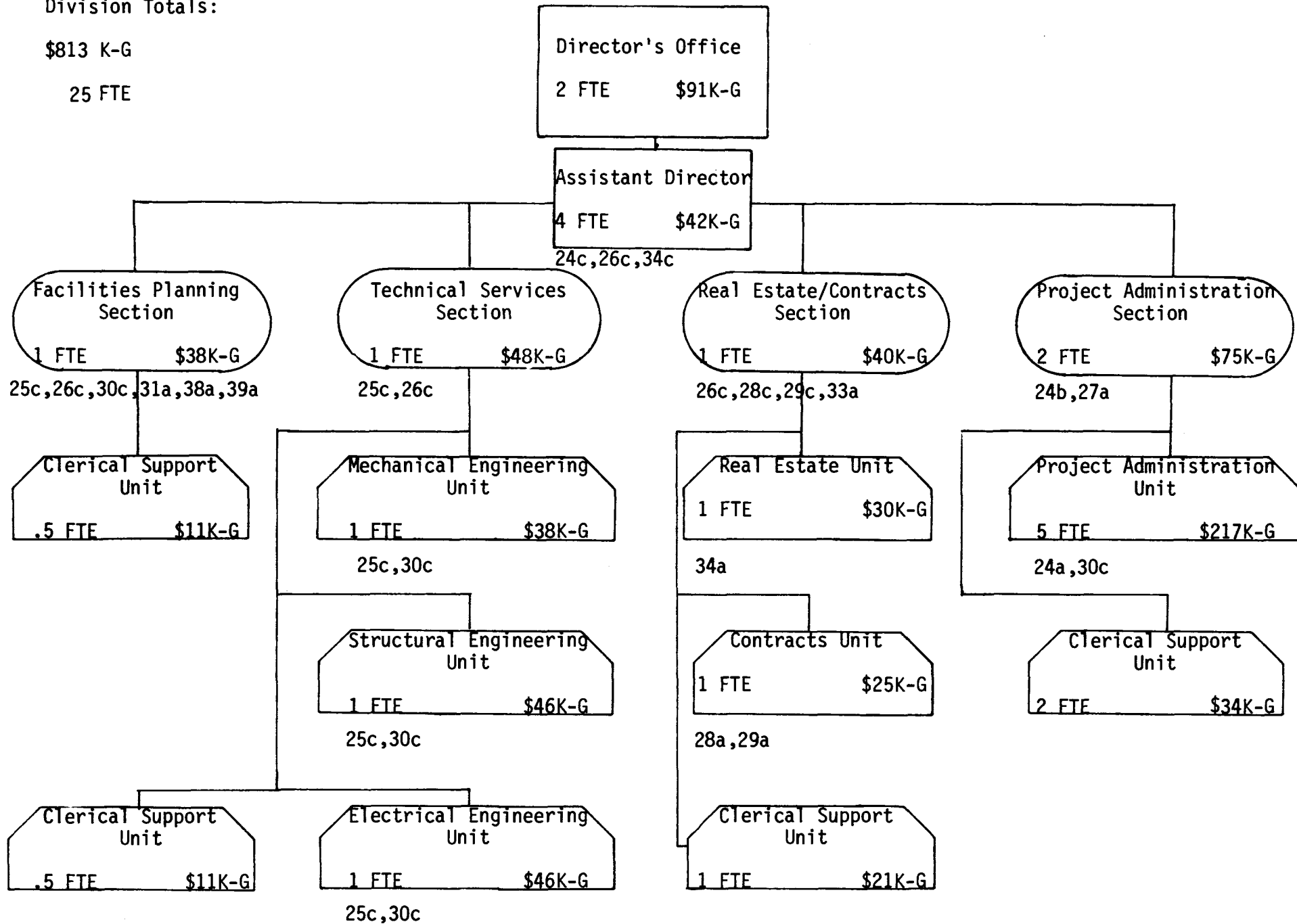

Agency Totals:

\$99 K-F
\$126 K-C

8 FTE

COLORADO MINORITY BUSINESS DEVELOPMENT AGENCY

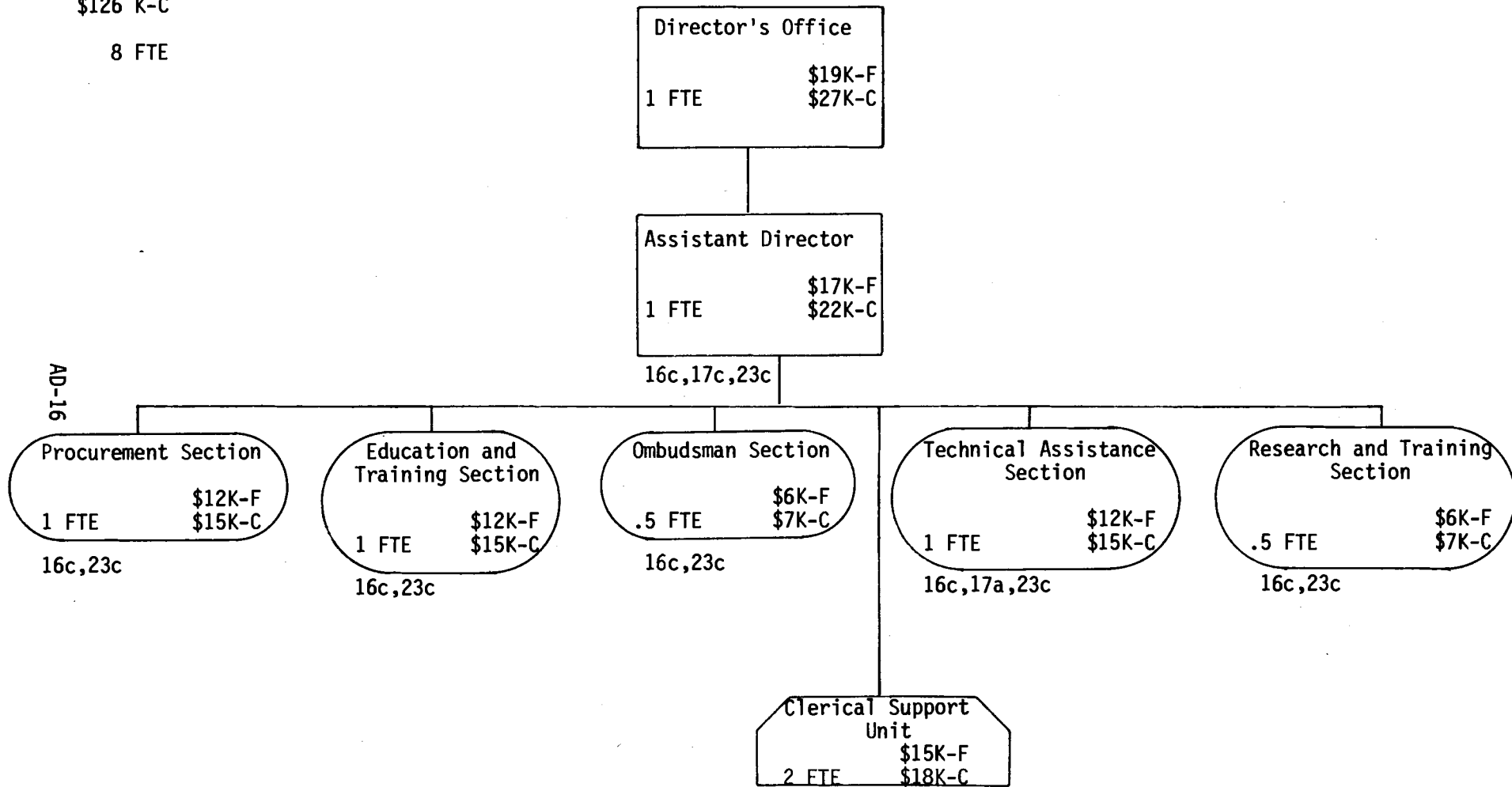

Division Totals:

\$5,373 K-C
107 FTE

DIVISION OF CENTRAL SERVICES

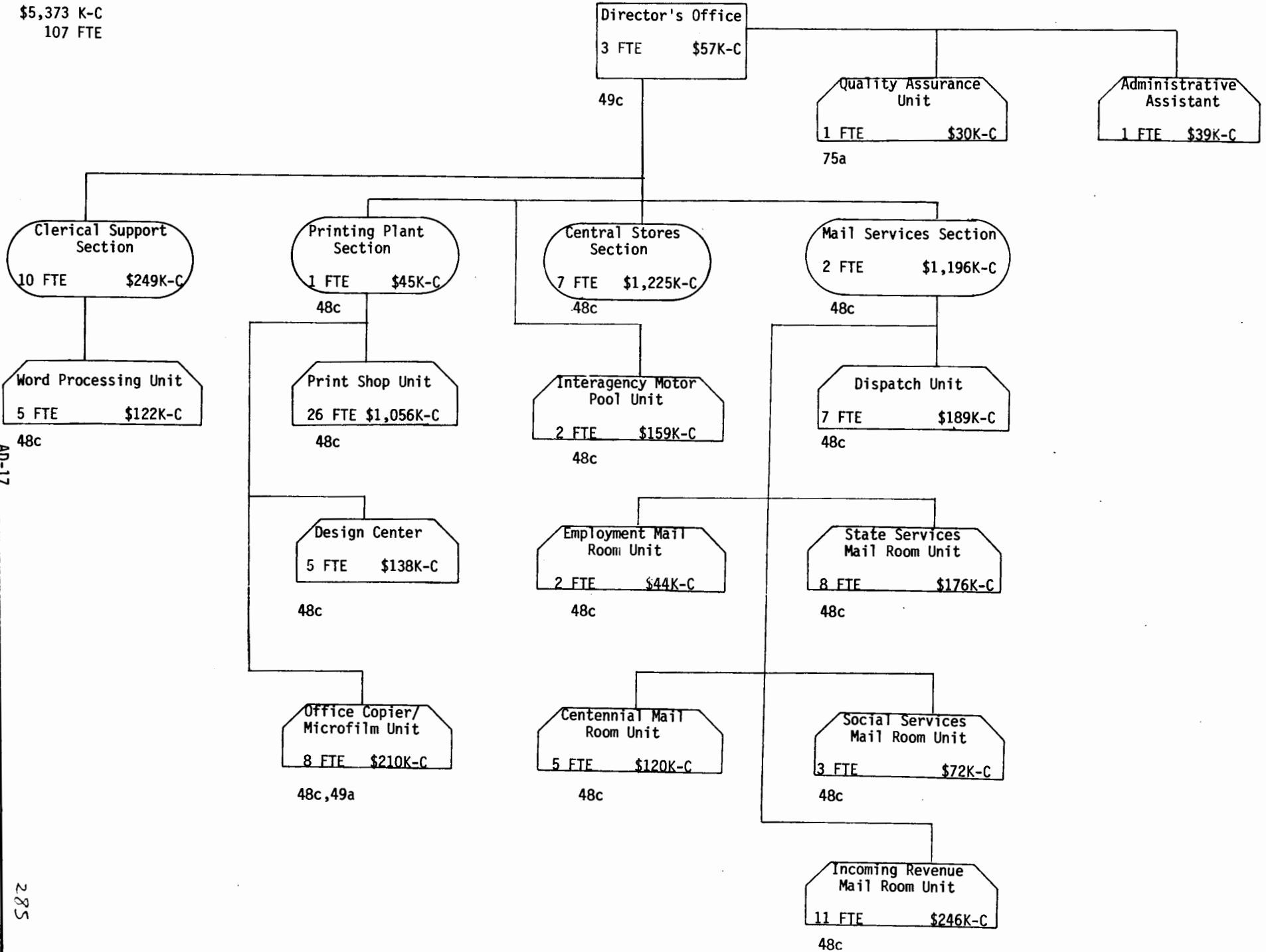

AD-17

Division Totals:

\$1,178 K-G
 \$1,872 K-C
 \$1,425 K-HUTF
 61 FTE

DIVISION OF COMMUNICATIONS

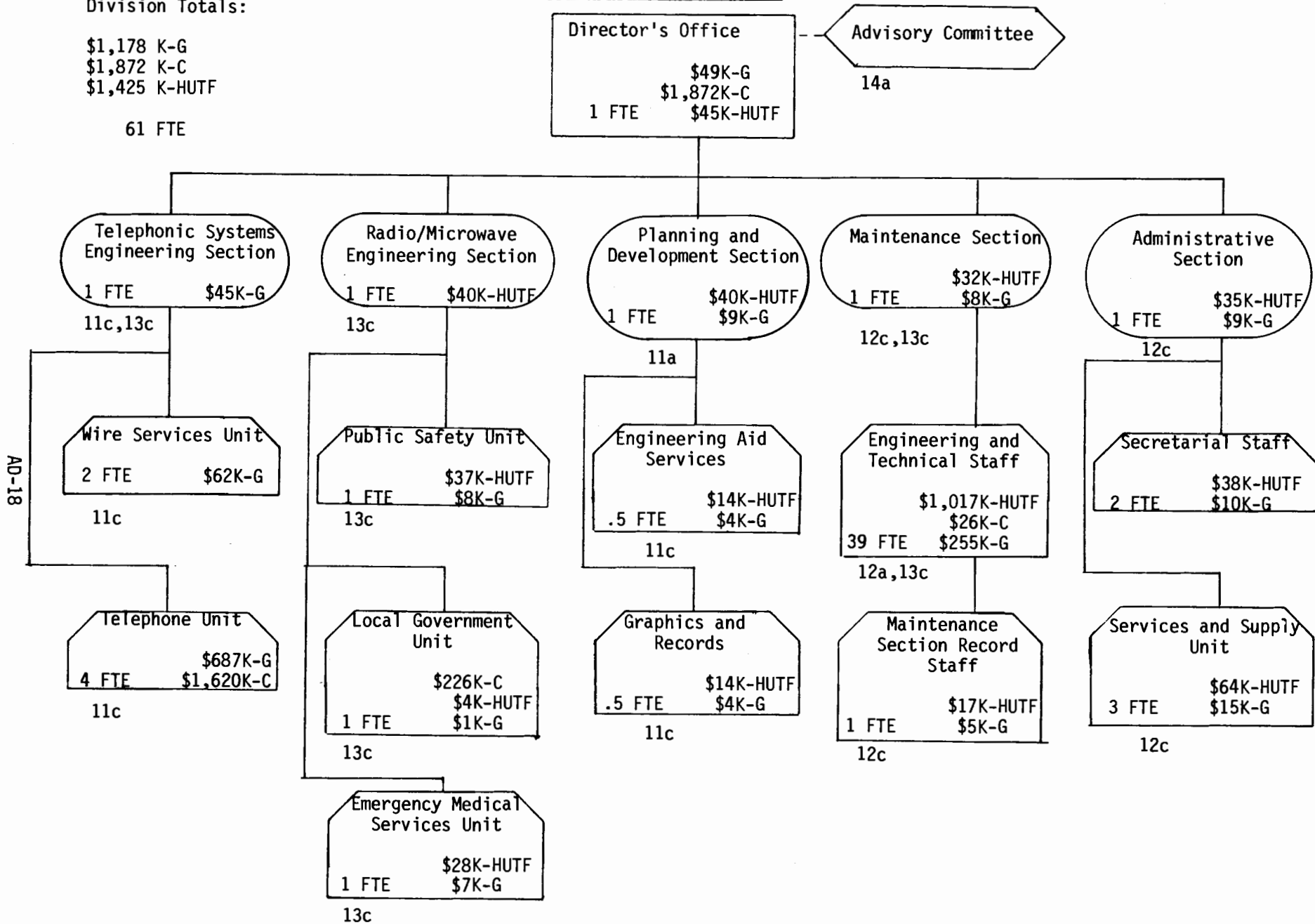

AD-18

Division Totals:

\$667 K-C
19 FTE

DIVISION OF HEARING OFFICERS

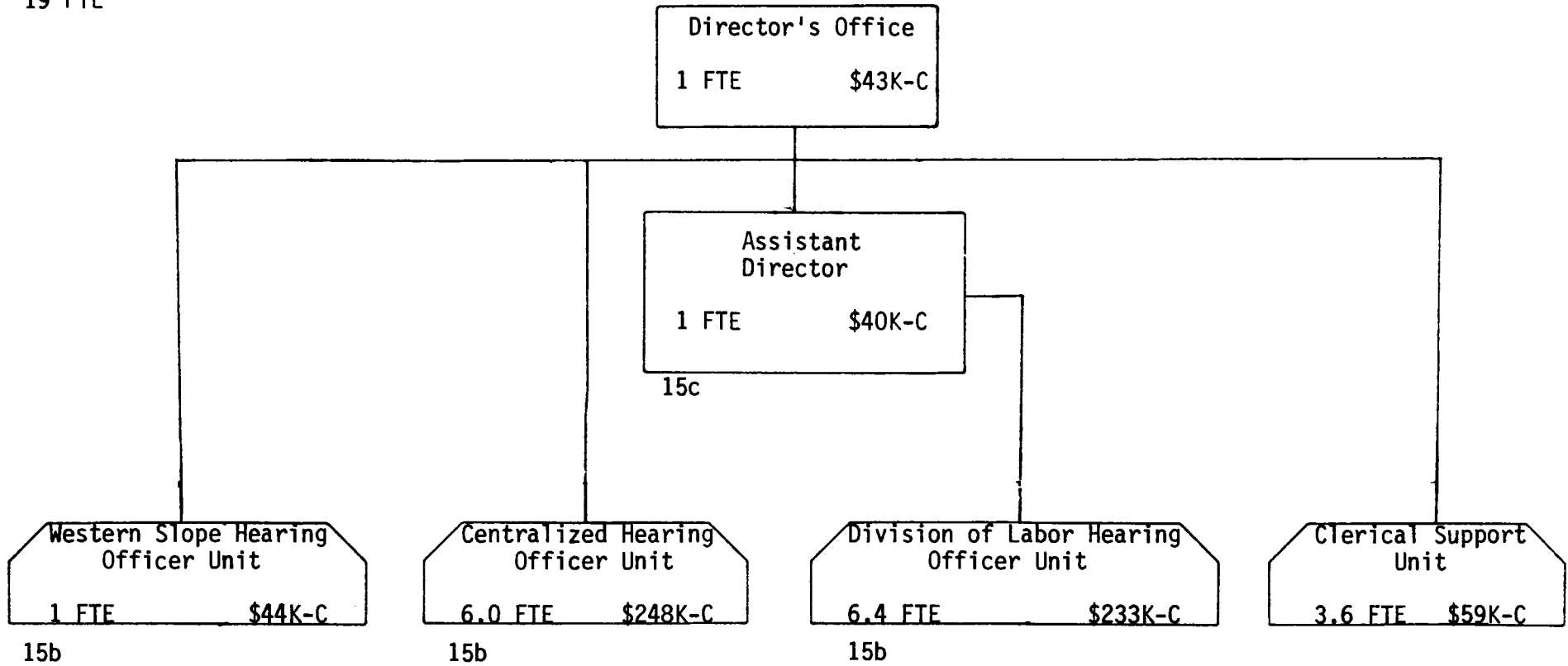

AN-19

Center Totals:

\$3,372 K-G
\$1,252 K-C

123 FTE

GENERAL GOVERNMENT COMPUTER CENTER

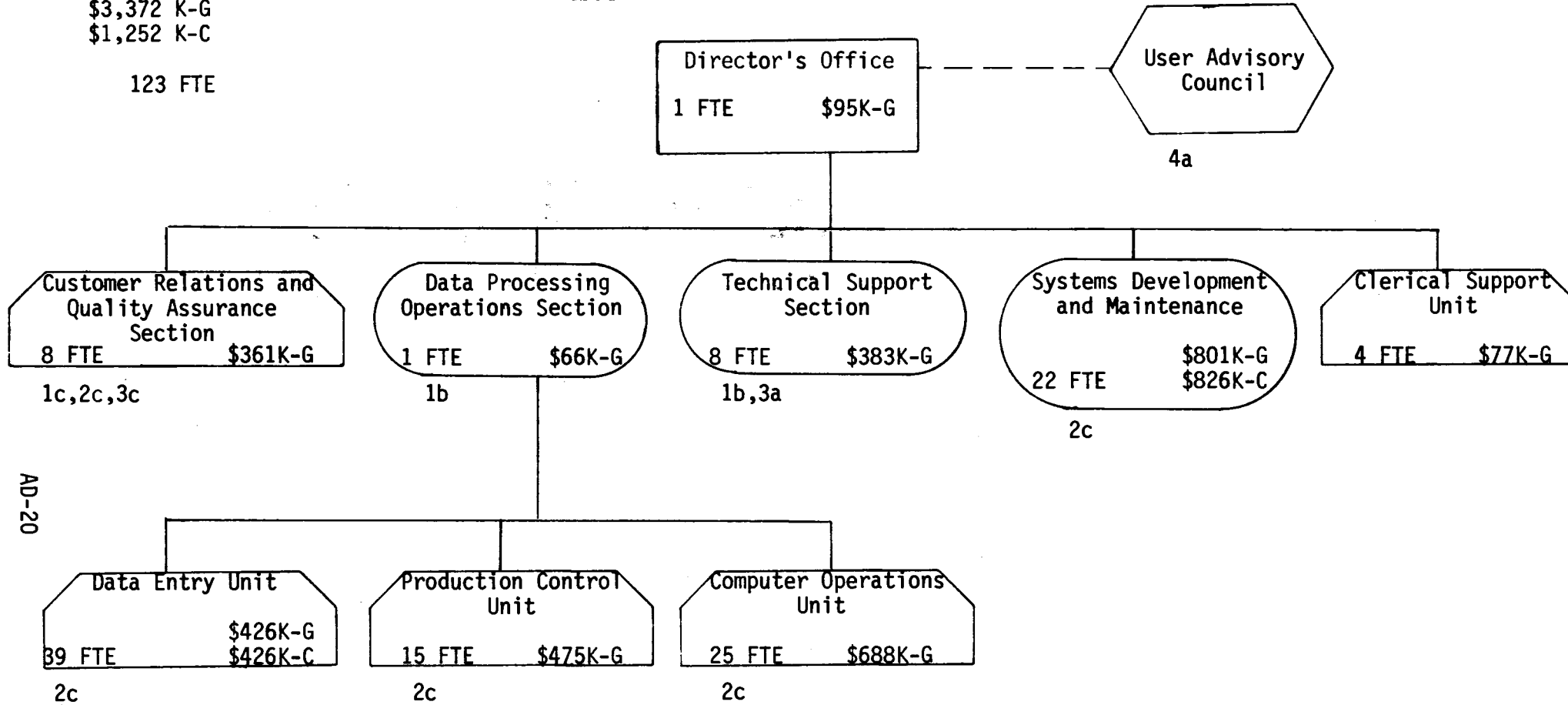

AD-20

Section Totals:

\$1,936 K-G
\$95 K-C

96 FTE

HOUSEKEEPING AND GROUNDS SECTION

Director's Office
1 FTE \$150K-G

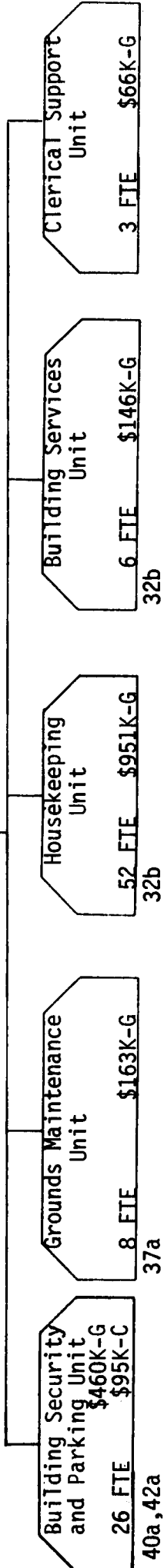

40a, 42a

37a

32b

32b

Division Totals:

\$284 K-C

7 FTE

DIVISION OF MANAGEMENT SERVICES

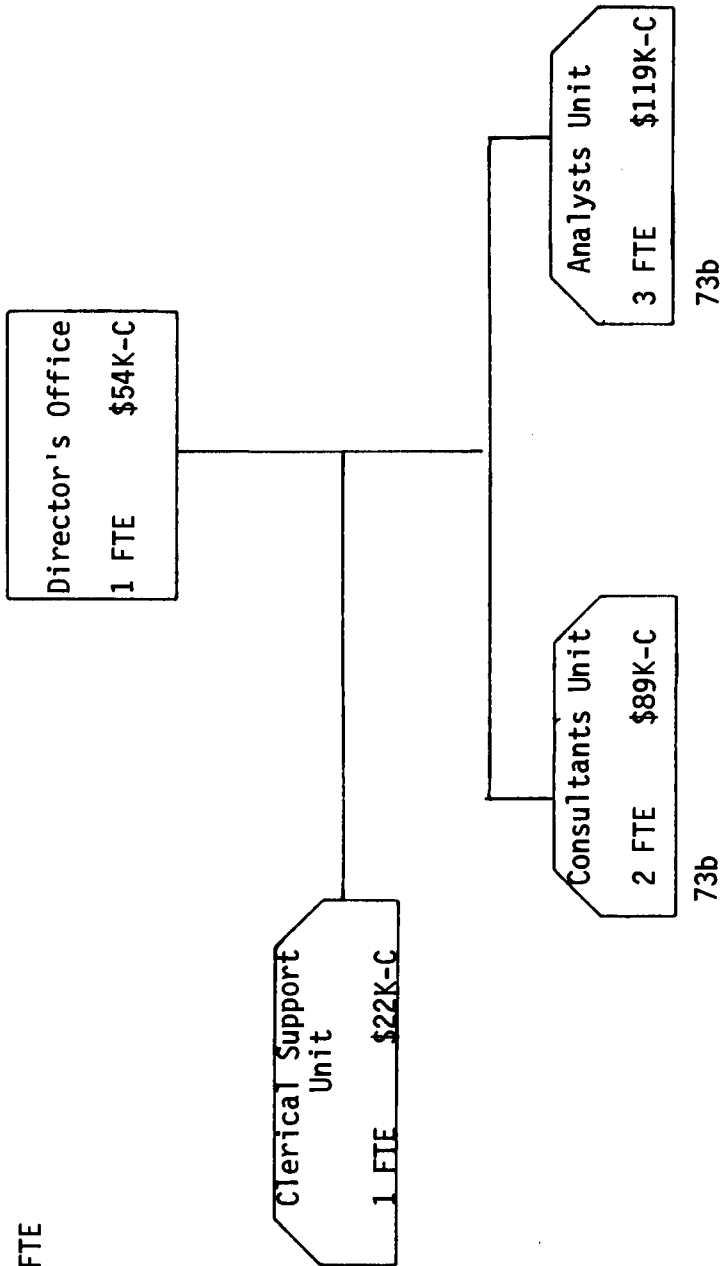

Section Totals:

\$1,547 K-G
\$183 K-C

30 FTE

PHYSICAL PLANT MAINTENANCE SECTION

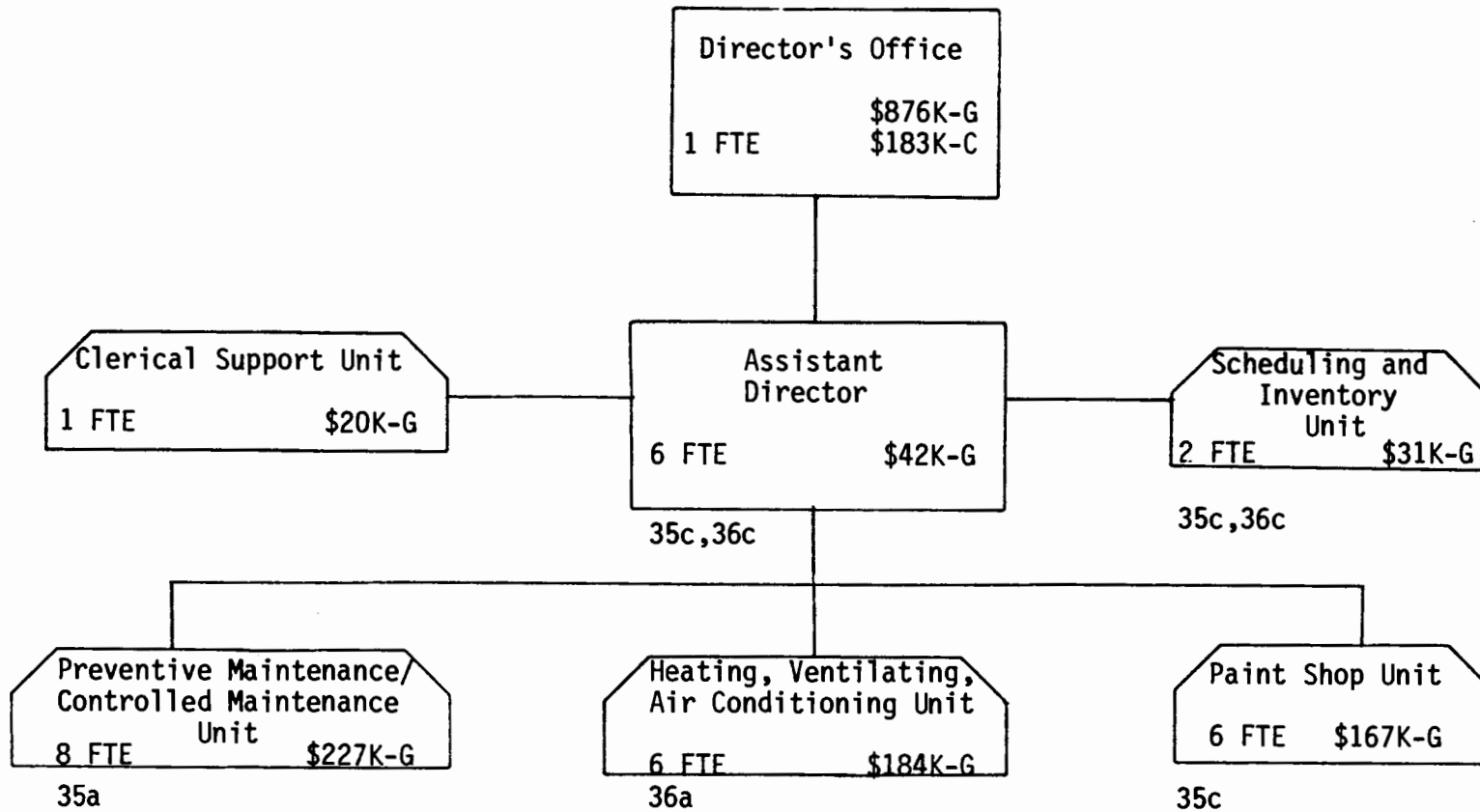

AD-23

Division Totals:

\$422 K-G
\$369 K-C

25 FTE

DIVISION OF PURCHASING

Insurance
Consultant
\$3K

70b

Director's Office
1 FTE \$90K-G

70b, 72a, 69a, 63a, 64a,
65a

Procurement
Advisory
Council

66a

Assistant State
Purchasing Director
1 FTE \$50K-G

63c

Purchasing Unit
7 FTE \$194K-G

67a, 68a

Energy Conservation
Unit
1 FTE \$50K-C

70c

Clerical Support
Unit
5 FTE \$88K-G

Colorado State
Agency for Surplus
Property
3 FTE \$105K-C

71b

Receiving Unit
2 FTE \$41K-C

71b

Warehouse Unit
3 FTE \$129K-C

71b

Clerical Support Unit
2 FTE \$44K-C

AD-24

DEPARTMENT OF AGRICULTURE

Promotes the Agricultural Activities of the State

	<u>Page</u>
Agricultural Products.....	AG-1
Beef.....	AG-1
Gasohol.....	AG-1
Sheep.....	AG-1
Market Development.....	AG-1
News and Data Collection.....	AG-2
Program Coordination.....	AG-3
State Fair.....	AG-3

Regulates Agricultural Activities

Controls.....	AG-3
Diseases.....	AG-3
Food.....	AG-3
Livestock.....	AG-3
Orchards.....	AG-4
Poultry.....	AG-4
Strays.....	AG-4
Pests.....	AG-4
Predators.....	AG-5
Inspections.....	AG-5
Animals.....	AG-5
Cattle and Horses.....	AG-5
Dairies.....	AG-6
Feeds.....	AG-6
Fertilizer.....	AG-6
Fruits and Vegetables.....	AG-7
Grain.....	AG-7
Plants.....	AG-7
Seeds.....	AG-8
Weights.....	AG-8
Licenses.....	AG-8
Registrations.....	AG-9

DEPARTMENT OF AGRICULTURE

Promotes the Agricultural Activities of the State

Agricultural Products

1. Promotes, in the interest of the producer and the consumer, the economic and efficient distribution of agricultural products; develops educational programs on Colorado's agricultural products for school students and other citizens. (Commissioner's Office, Consumer and Food Specialist; 35-1-104, C.R.S. 1973)

Beef

2. Conducts activities relative to beef promotion: advertising, education, research and other methods to increase the efficient production, distribution, use and sale of cattle and beef products. Collects a fee to promote the state beef board's activities. (Brand Inspection Division, Colorado Beef Board; 35-57-101, C.R.S. 1973)

Gasohol

3. Conducts or contracts for alcohol fuels research; provides assistance to the alcohol fuels industry, local, state and federal agencies; prepares and disseminates alcohol fuels information; monitors state and federal alcohol fuels legislation and regulations. (Commissioner's Office, Resource Analysis Section; 35-39-104, C.R.S. 1973)

Sheep

4. Promotes by research, education, advertising and other methods, the increased and efficient production, distribution, use and sale of sheep and sheep products. Collects an assessment fee to defray expenses of the program. (Brand Inspection Division, Colorado Sheep and Wool Board; 35-57.5-105, C.R.S. 1973)

Market Development

5. Works with agricultural commodity organizations on marketing programs; directs producer to consumer marketing activities and domestic marketing programs; develops export marketing programs involving Colorado agricultural products and exporters; develops marketing systems and agricultural communication networks in cooperation with surrounding

communication networks in cooperation with surrounding states and the United States Department of Agriculture; and administers federal-state marketing improvement programs, using federal funds on an "in kind" matching basis. (Markets Division, Market Services Section; 35-1-104, C.R.S. 1973)

6. Administers and enforces the Colorado Agricultural Marketing Act of 1939. (Market Division, Market Services Section; 35-28-116, C.R.S. 1973)
7. Assists in improving the transportation of agricultural products and provides resource backing for members of the agricultural marketing task force developed to study and recommend alternatives for the marketing of agricultural products. (Market Division, Market Services Section; 35-1-104, C.R.S. 1973)

News and Data Collection

8. Calls upon state and local officials to provide statistical data relating to the agricultural community. (Market Division, Agricultural Statistics Unit; 35-2-101 and 35-2-103, C.R.S. 1973)
9. Publishes a book listing of all brands on record. (Brand Inspection Division, Administrative Support Unit; 35-43-108, C.R.S. 1973)
10. Processes and records brand applications; publishes brands and transfers; collects assessment fees. (Brand Inspection Division, Administrative Support Unit; 35-43-105, 35-43-113, 35-43-115, and 35-43-116, C.R.S. 1973)
11. Prepares information for the general public and for the state's agricultural community. (Commissioner's Office, Public Information Specialist; 35-1-104, C.R.S. 1973)
12. Provides the state's portion of a federal-state market news program covering livestock, fruit and vegetables and poultry and eggs. (Markets Division, Services Section; 35-1-104, C.R.S. 1973)
13. Conducts or contracts for studies of agricultural use of land, water and energy; reviews environmental impact statements of proposed projects with significant agricultural impact as a part of the department's duty to inquire into the needs of agriculture and make appropriate recommendations. (Commissioner's Office, Resource Analysis Section; 35-1-104, C.R.S. 1973)

Program Coordination

14. Controls and manages the functions of the state Department of Agriculture. (Commissioner's Office; 35-1-106, C.R.S. 1973)
15. Plans and manages public education and information programs; inquires into the needs of agriculture and makes recommendations to the commissioner, governor and general assembly. Encourages cooperation between producers and distributors. (Commissioner's Office, Assistant to the Commissioner; 35-1-104 and 35-1-107 (4), C.R.S. 1973)
16. Works with farmer-owned cooperatives, assisting in their organizations, development of articles of incorporation, by-laws and marketing controls. (Market Division, Market Services Section; 7-56-101, C.R.S. 1973)

State Fair

17. Conducts the annual Colorado State Fair and Industrial Exposition. (State Fair Division; 35-65-105, C.R.S. 1973)
18. Enters into agreements for the leasing of state fair facilities. (State Fair Division; 35-65-107, C.R.S. 1973)

Regulates Agricultural Activities

Controls

Diseases

Food

19. Investigates complaints regarding edible and inedible products. (Division of Animal Industry, Meat/Frozen Food Section; 35-33-101, 35-7-201, and 35-59-101, C.R.S. 1973)

Livestock

20. Administers programs for prevention and control of livestock disease as it is found in Colorado. (Division of Animal Industry, State Veterinarian; 35-50-101, C.R.S. 1973)
21. Detects, prevents and controls livestock disease in the field by diagnosis and quarantine. (Division of Animal Industry, State Veterinarian; 35-50-101, C.R.S. 1973)

22. Tests, detects and records various livestock diseases for state and federal veterinarians. (Division of Animal Industry, State Veterinarian; 35-50-101, C.R.S. 1973)

Orchards

23. Conducts an annual survey of peach orchards on the western slope to locate and destroy any trees infected with peach mosaic disease. (Division of Plant Industry, Nursery and Quarantine Section; 35-6-104, C.R.S. 1973)

Poultry

24. Seizes and condemns all contaminated, decomposed, adulterated poultry and rabbit products. (Division of Inspection and Consumer Services, Field Programs Section, Poultry and Egg Unit; 35-20-105, C.R.S. 1973)

Strays

25. Takes up strays; collects reasonable charges; conducts sales of strays; arbitrates the cost of the caretaker handling the stray and ensures that the owner pays handling fees; enforces the statute. (Division of Brand Inspection; 35-44-102 and 35-44-111, C.R.S. 1973)

Pests

26. Administers and coordinates beneficial insect programs on targeted pests and weeds; procures new beneficial insect species from available sources. (Division of Plant Industry, Biological Pest Control Section; 35-6-101, et seq., C.R.S. 1973)
27. Plans and initiates rearing programs for mass production and distribution of beneficial insects on target pests of forage crops, ornamentals, fruits and noxious weeds; collects and recolonizes beneficial insects. (Division of Plant Industry, Biological Pest Control Section; 35-6-101, et seq., C.R.S. 1973)
28. Performs indigenous and incipient pest surveys as crop protection measures. (Division of Plant Industry, Biological Pest Control Section; 35-6-101, C.R.S. 1973)
29. Conducts insect or plant disease surveys on certain crops or ornamental plants to protect Colorado agriculture and landscaping. (Division of Plant Industry, Nursery and Quarantine Section; 35-1-104, C.R.S. 1973)

30. Provides technical advice in the establishment of pest control districts; compiles an annual report for each pest control district. (Division of Plant Industry, Seed, Apiary and Pest District Section; 35-5-104, C.R.S. 1973)
31. Organizes and coordinates grasshopper and range caterpillar control programs and surveys. (Division of Plant Industry, Seed, Apiary and Pest District Section; 35-5-117, C.R.S. 1973)
32. Administers programs to control, suppress and eradicate rodents. (Division of Animal Industry, Rodent Control Section; 35-7-101, C.R.S. 1973).
33. Assists local governments, industry and private citizens with rodent problems. (Division of Animal Industry, Rodent Control Section; 35-7-101, C.R.S. 1973)

Predators

34. Assists local and federal government and livestock owners with predation problems. (Division of Animal Industry, Predatory Control Section; 35-40-101 and 35-7-201, C.R.S. 1973)

Inspections

Animals

35. Investigates cruelty to animal reports. (Division of Animal Industry, Animal Protection Control Section; 35-42-101 and 24-1-123 (4) (c) (II), C.R.S. 1973)

Cattle and Horses

36. Inspects brands; handles and disposes of abandoned livestock including the publication of notice, sale and distribution of proceeds. (Division of Brand Inspection; 35-44-112 and 35-44-133, C.R.S. 1973)
37. Inspects, levies and collects a per head brand inspection tax on all cattle, horses and mules that are offered for sale or are to be moved interstate or intrastate except as exempted; furnishes inspection certificates to owners; and reports to state board of stock inspection. (Division of Brand Inspection; 35-53-101 and 35-53-114, C.R.S. 1973)
38. Inspects all cattle, horses, mules and burros upon entering a public livestock market for brands, earmarks and other

identifying characteristics; impounds sale proceeds where ownership is questionable; collects fees and issues certificates. (Division of Brand Inspection; 35-55-112, C.R.S. 1973)

39. Inspects livestock hides that are to be shipped; inspects vehicles transporting livestock or carcasses; siezes livestock or carcasses if ownership is questionable; and distributes sale proceeds. (Division of Brand Inspection; 35-53-115, C.R.S. 1973)
40. Issues a permanent transportation permit to competition horses used in rodeo or show competitions for interstate and intrastate movement. (Division of Brand Inspection; 35-53-129, C.R.S. 1973)

Dairies

41. Administers, licenses and tests production and manufacturing of dairy products. (Division of Animal Industry, Dairy Section; 35-24-101 and 35-34-101, C.R.S. 1973)
42. Investigates, licenses, tests and enforces statutes pertaining to dairy products. (Division of Animal Industry, Dairy Section; 35-24-101 and 35-34-101, C.R.S. 1973)

Feeds

43. Performs medicated feed mill inspections. (Division of Inspection and Consumer Services, Field Programs Section, Feed Unit; 35-60-106, C.R.S. 1973).
44. Inspects and samples fertilizer products, eggs and feed. (Division of Inspection and Consumer Services, Field Programs Section; 35-12-108, 35-60-110 and 35-21-104, C.R.S. 1973)

Fertilizer

45. Processes applications for licenses and registration of commercial fertilizer products, and licenses for custom formulated fertilizer manufacturing facilities, manipulators and specialty fertilizer applicators; collects inspection fees and enforces the statute. (Division of Inspection and Consumer Services, Field Programs Section, Fertilizer Unit; 35-12-104 and 35-12-106, C.R.S. 1973)

46. Inspects anhydrous ammonia bulk plants and equipment for compliance with safety standards. (Division of Inspection and Consumer Services, Field Programs Section, Fertilizer Unit; 35-13-103 and 104, C.R.S. 1973)
47. Conducts field audits for the collection and enforcement of commercial feed tonnage taxes and inspection fees on commercial fertilizers, soil conditioners and agricultural liming materials. (Division of Inspection and Consumers Services, Records and Reports Section; 35-60-108 and 35-12-106, C.R.S. 1973)
48. Performs analyses of fertilizer, soil conditioner and agricultural liming materials. (Division of Inspection and Consumer Services, Standards Laboratory Section; 35-60-108, 35-12-108 and 35-10-113, C.R.S. 1973)

Fruits and Vegetables

49. Provides inspections and certification of fresh fruits and vegetables at shipping points. (Division of Market, Fruit and Vegetable Inspections Section; 35-23-101 and 35-23-103, C.R.S. 1973)

Grain

50. Inspects grain and bean storage facilities to determine storage obligations. (Division of Inspection and Consumer Services, Records/Reports Section, Grain Warehouse Inspection Unit; 12-16-106, C.R.S. 1973)

Plants

51. Inspects flower and ornamental plant-growing greenhouses and field grown flowers for pests and diseases; inspects shippers of corn and other grains subject to European corn borer; inspects plant commodities requiring phytosanitary export certificates. (Division of Plant Industry, Nursery and Quarantine Section; 35-4-111, C.R.S. 1973)
52. Imposes quarantine measures on certain imported plant materials to protect from the spread of injurious insect pests and plant diseases; inspects to enforce quarantine requirements. (Division of Plant Industry, Nursery and Quarantine Section; 35-4-109 and 35-4-110, C.R.S. 1973)

Seeds

53. Inspects, samples and analyzes seeds to determine compliance with state and federal seed laws. (Division of Plant Industry, Seed, Apiary and Pest District Section; 35-27-109, C.R.S. 1973)

Weights

54. Inspects and measures all packaged commodities for accurate net contents declaration; inspects and tests small capacity weighing and measuring devices. (Division of Inspection and Consumer Services, Field Programs Section; 35-14-108, 35-14-110, 35-14-111 and 35-14-123, C.R.S. 1973)

Licenses

55. Licenses beekeepers; inspects bee yards and honeybees for contagious diseases; inspects and issues stop sales on adulterated or artificial bee products. (Division of Plant Industry, Seed, Apiary and Pest District Section; 35-25-106, 35-25-107 and 35-25-109, C.R.S. 1973)
56. Administers the surety bond requirements prior to issuance of a license to operate a slaughter plant; conducts brand inspections on hides; collects inspection fees. (Division of Brand Inspection; 12-11-101 and 12-11-106, C.R.S. 1973)
57. Processes license applications and sets bonds for dealer, broker and commission merchants of agricultural products; investigates complaints; enforces the statute. (Division of Inspection and Consumer Services, Record/Reports Section; 12-16-102, 12-16-105, and 12-16-106, C.R.S. 1973)
58. Licenses and inspects sellers of nursery stock to provide assurance that the stock is properly labeled and free of insects and diseases and, in the case of sod, free of weeds. (Division of Plant Industry, Nursery and Quarantine Section; 35-26-103, C.R.S. 1973)
59. Licenses commercial pesticide applicators and registers equipment. (Division of Plant Industry, Pesticide/Pesticide Applicator Section; 35-10-103, C.R.S. 1973)
60. Processes applications for candlers and egg-breaking facilities licenses; inspects egg-breaking facilities for sanitation; enforces statute. (Division of Inspection and Consumer Services, Field Programs Section, Poultry and Egg Unit; 35-21-104, C.R.S. 1973)

61. Processes applications for poultry and egg dealers and processors licenses; inspects processing facilities for sanitation; reviews for approval all plans for new or modified processing plants; enforces statute. (Division of Inspection and Consumer Services, Field Programs Section, Poultry and Egg Unit; 35-20-104, C.R.S. 1973)
62. Processes license applications for the operation of scales, textile meters or cordage meters; tests licensed devices every twelve months; collects proper license fees; administers and enforces the statute. (Division of Inspection and Consumer Services, Field Programs Section, Small Scales Unit; 35-14-108 and 35-14-123, C.R.S. 1973)
63. Licenses structural pest control operators; determines compliance with the law. (Division of Plant Industry, Pesticide/Pesticide Applicator Section; 35-11-101, et seq., C.R.S. 1973)
64. Processes applications for commercial weighing and measuring devices; licenses and bonds device salesmen and repairmen and weighmasters. (Division of Inspection and Consumer Services, Weights and Measures Section; 35-14-108 and 35-14-123, C.R.S. 1973)

Registrations

65. Processes applications for commercial feeding stuffs registrations; reviews feed sample analyses; enforces statute. (Division of Inspection and Consumer Services, Field Programs Section; 35-60-103, 35-60-104, 35-60-110, and 35-60-111, C.R.S. 1973)
66. Registers all pesticides advertised, distributed or sold in the state; licenses pesticide dealers. (Division of Plant Industry, Pesticide/Pesticide Applicator Section; 35-9-104, C.R.S. 1973)
67. Tests, inspects and calibrates commercial scales over 2,000-pound capacity; tests, calibrates, maintains and stores state weights and measuring devices; tests grain moisture meters; tests milk tanks for volume accuracy. (Division of Inspection and Consumer Services, Weight and Measures Section; 35-14-103, 35-14-104, and 35-14-110, C.R.S. 1973)
68. Carries out provisions of contract for inspection and testing of small weights and measures devices. (Division of Inspection and Consumer Services, Weights and Measures Section; 35-14-114, C.R.S. 1973)

Department
Totals:

\$5,823 K-G
\$5,543 K-C
\$104 K-F

299.9 FTE

DEPARTMENT OF AGRICULTURE

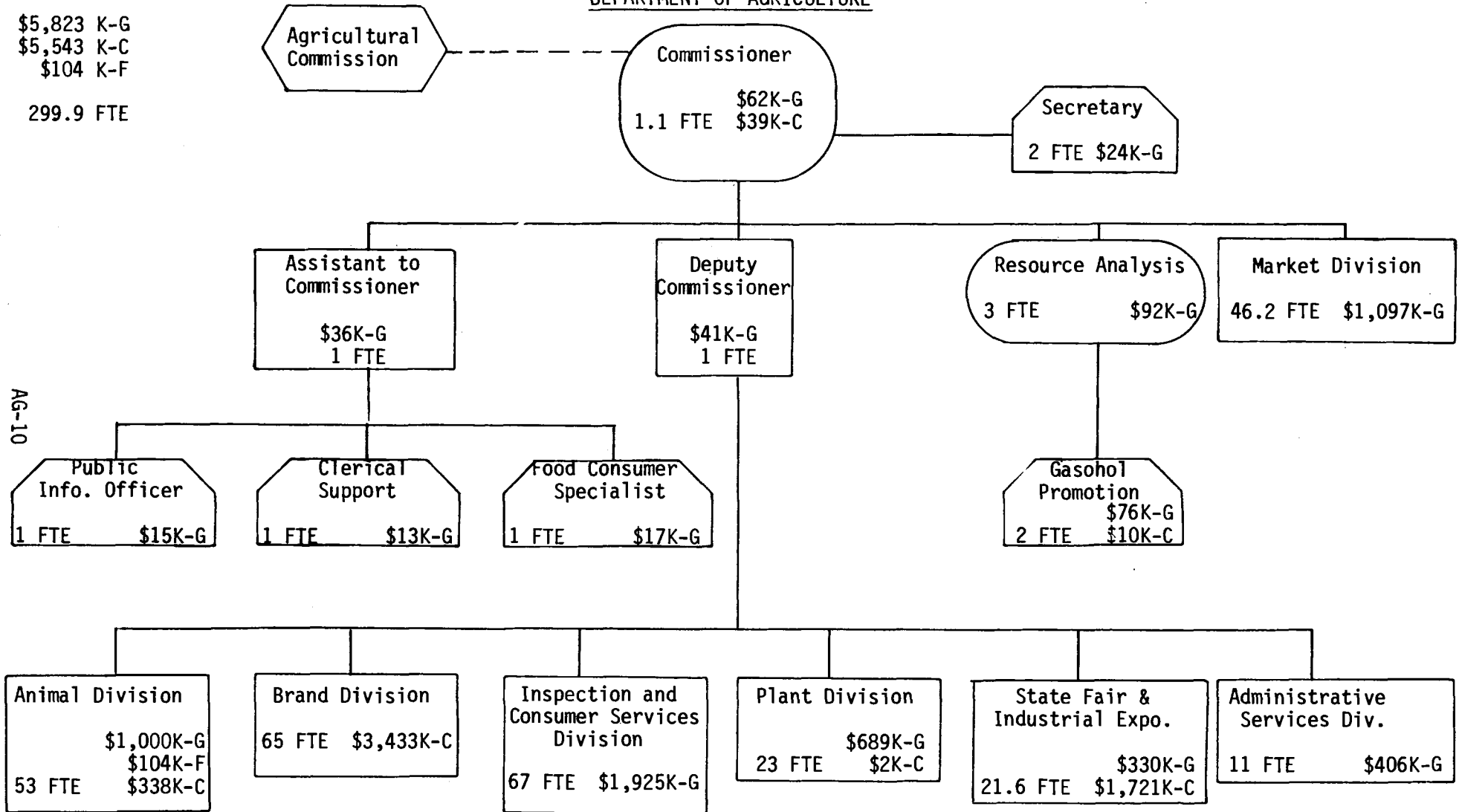

AG-10

Office Totals:

\$352 K-G

\$49 K-C

13.1 FTE

OFFICE OF THE COMMISSIONER

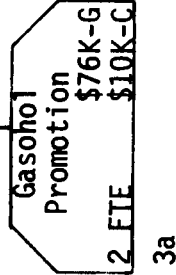
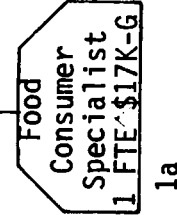
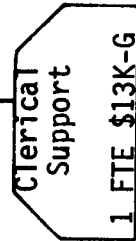
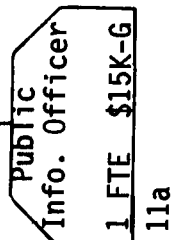
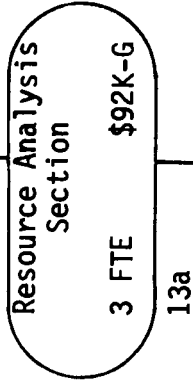
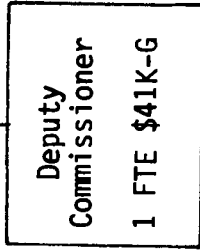
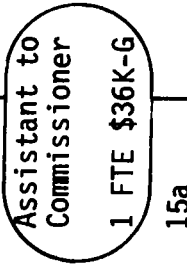
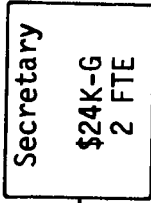
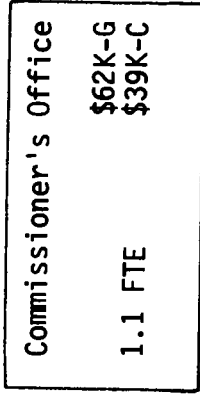
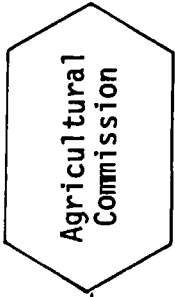

Division Totals: \$406 K-G*

11 FTE

ADMINISTRATIVE SERVICES DIVISION

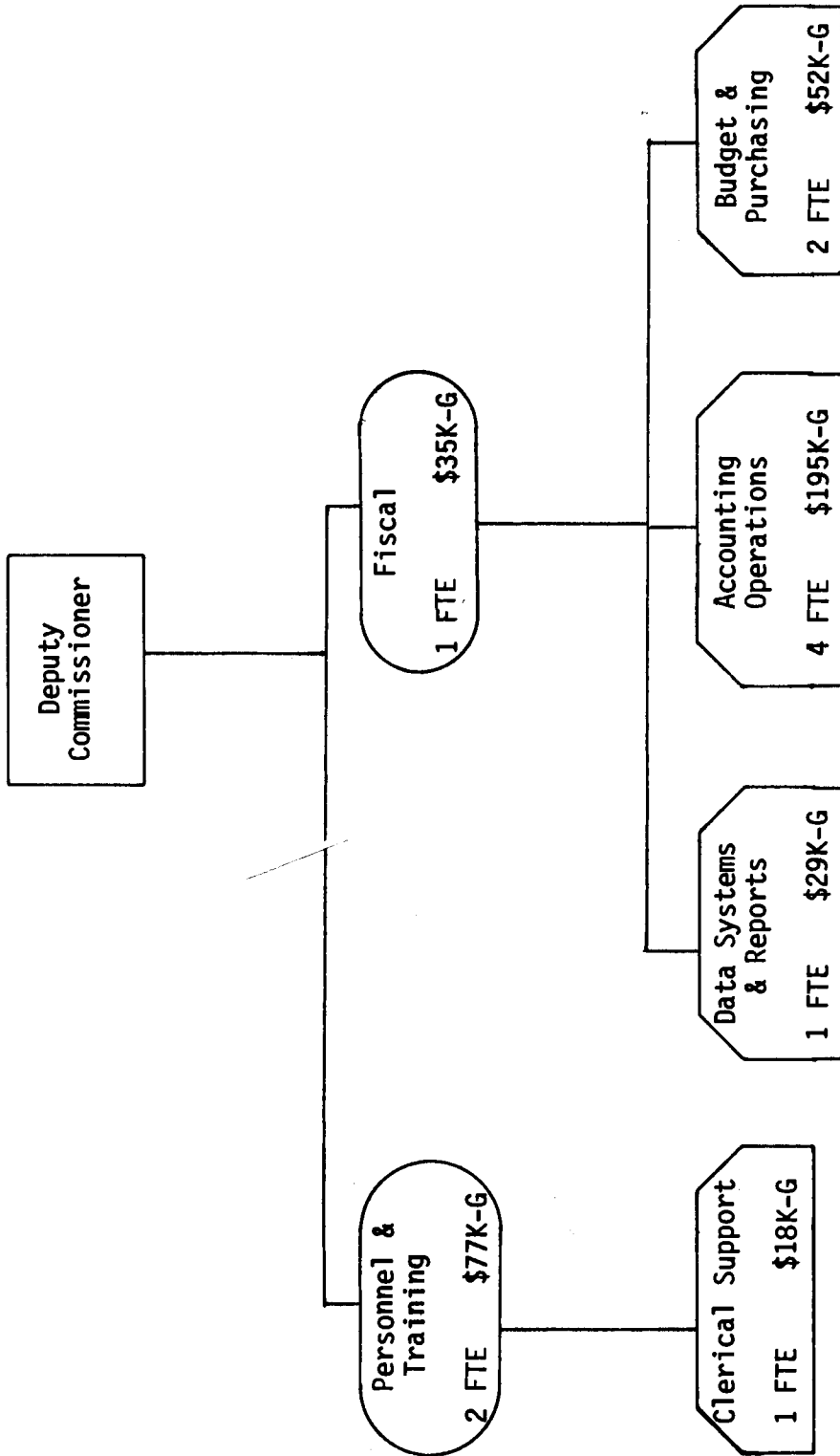

* Includes 25% of the Deputy Commissioner costs.

Division Totals:

\$1,012 K-G

\$378 K-C

\$104 K-F

53 FTE

ANIMAL INDUSTRY DIVISION

AG-13

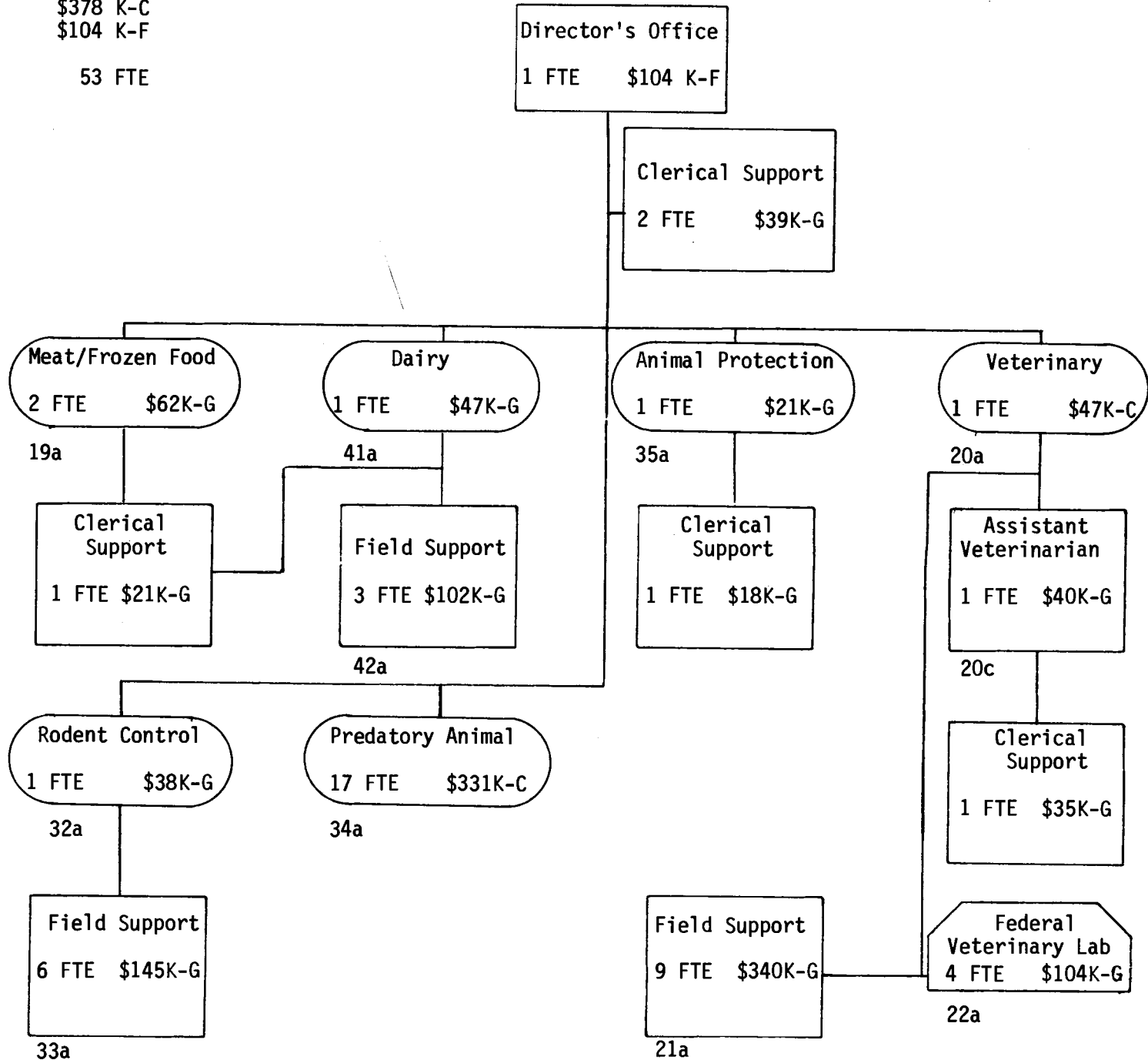

Division Totals:

\$3,433 K-C
65 FTE

BRAND INSPECTION DIVISION

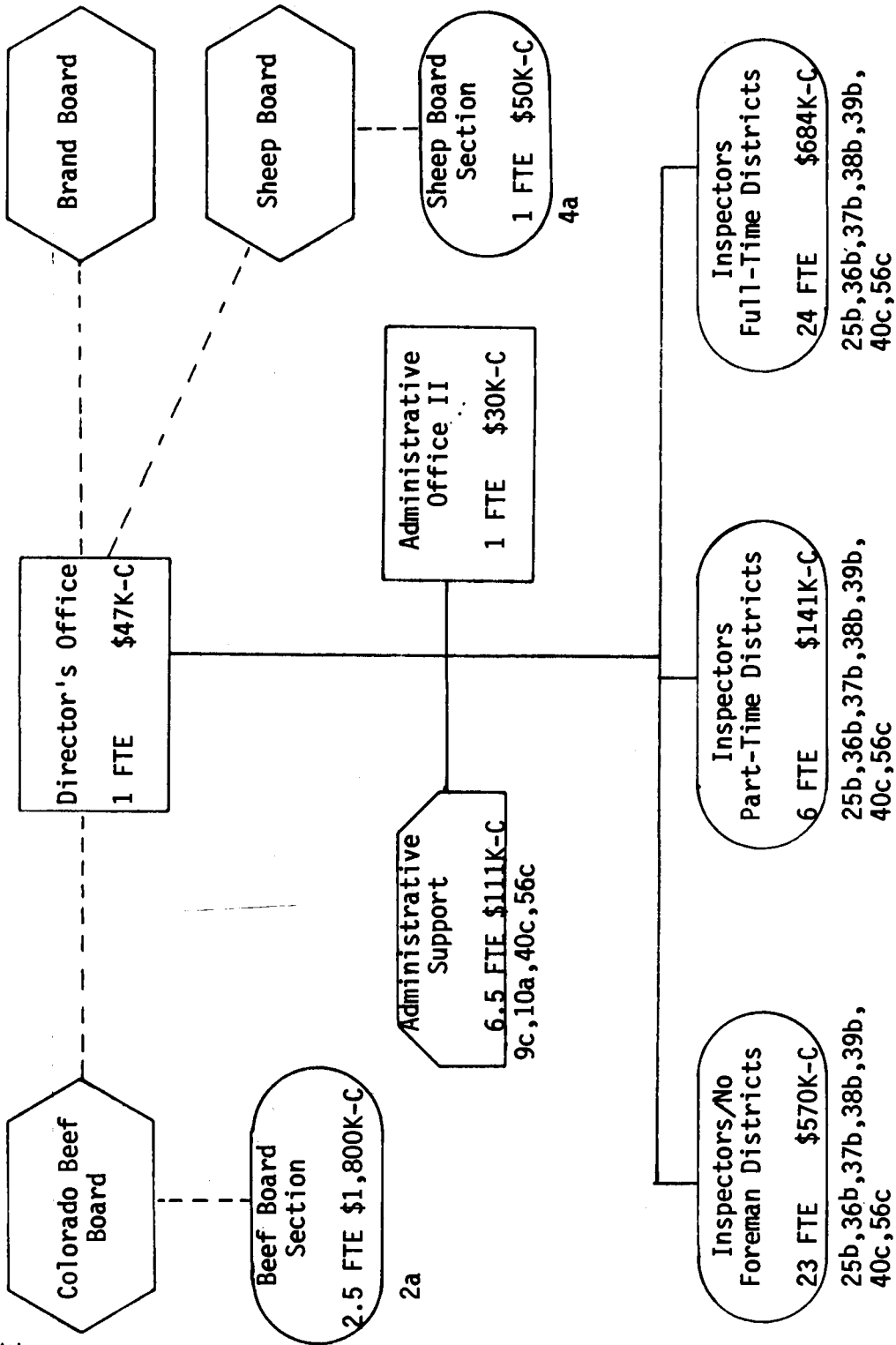

Division Totals:

\$1,721 K-C
\$330 K-G
21.6 FTE

COLORADO STATE FAIR

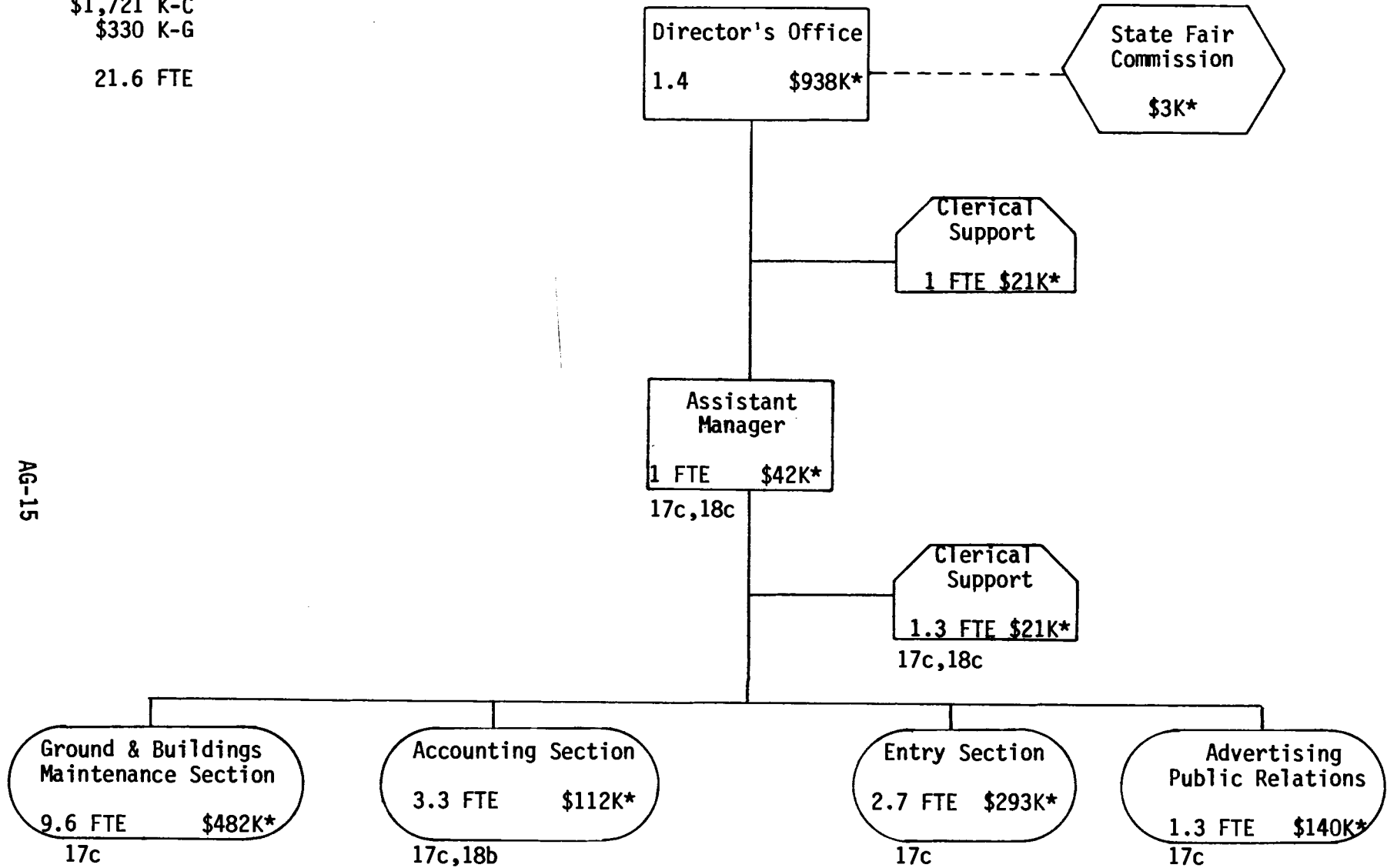

* Funding sources were not available.

AG-16

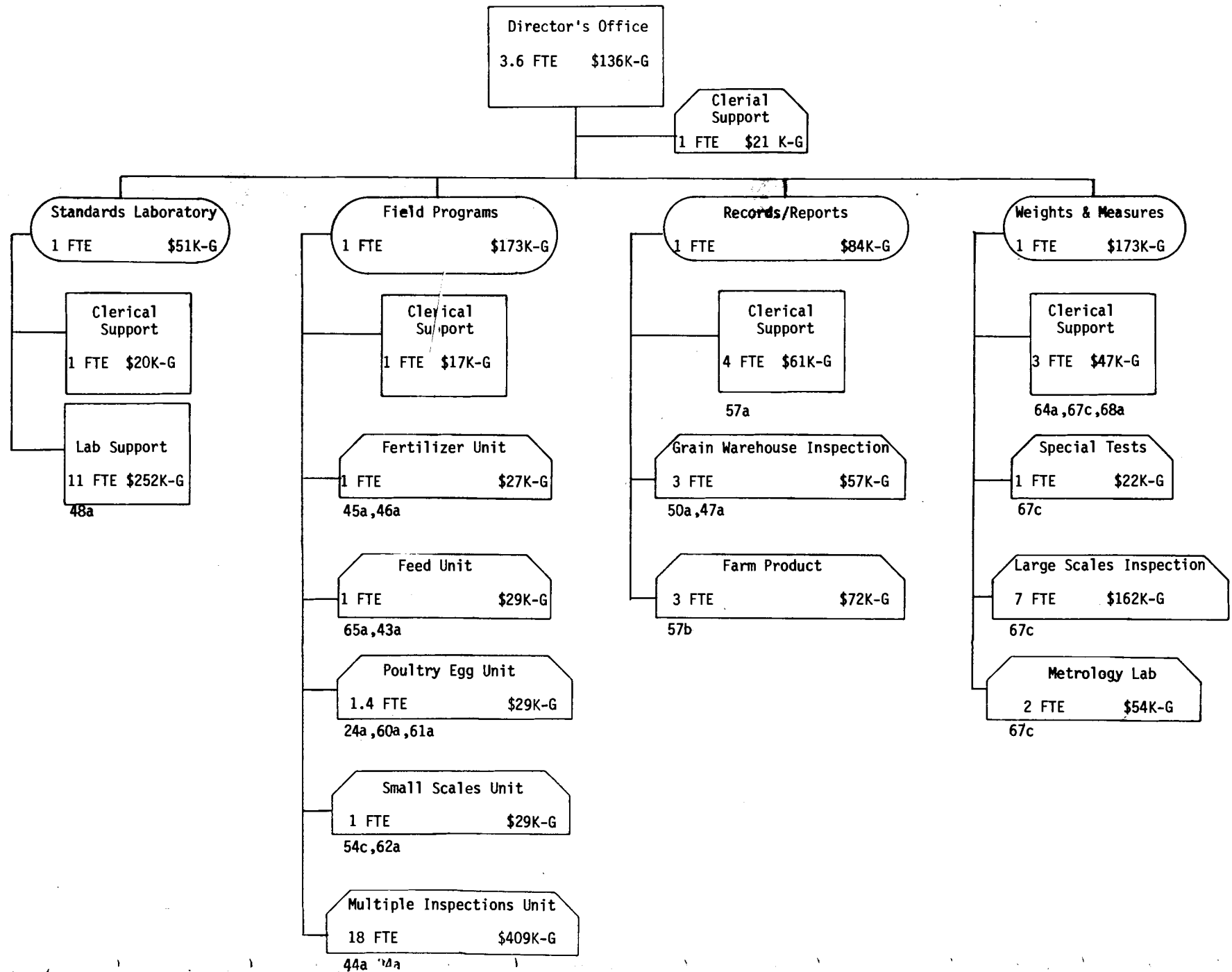

Division Totals:

\$1,097 K-G

46.2 FTE

MARKETS DIVISION

AG-17

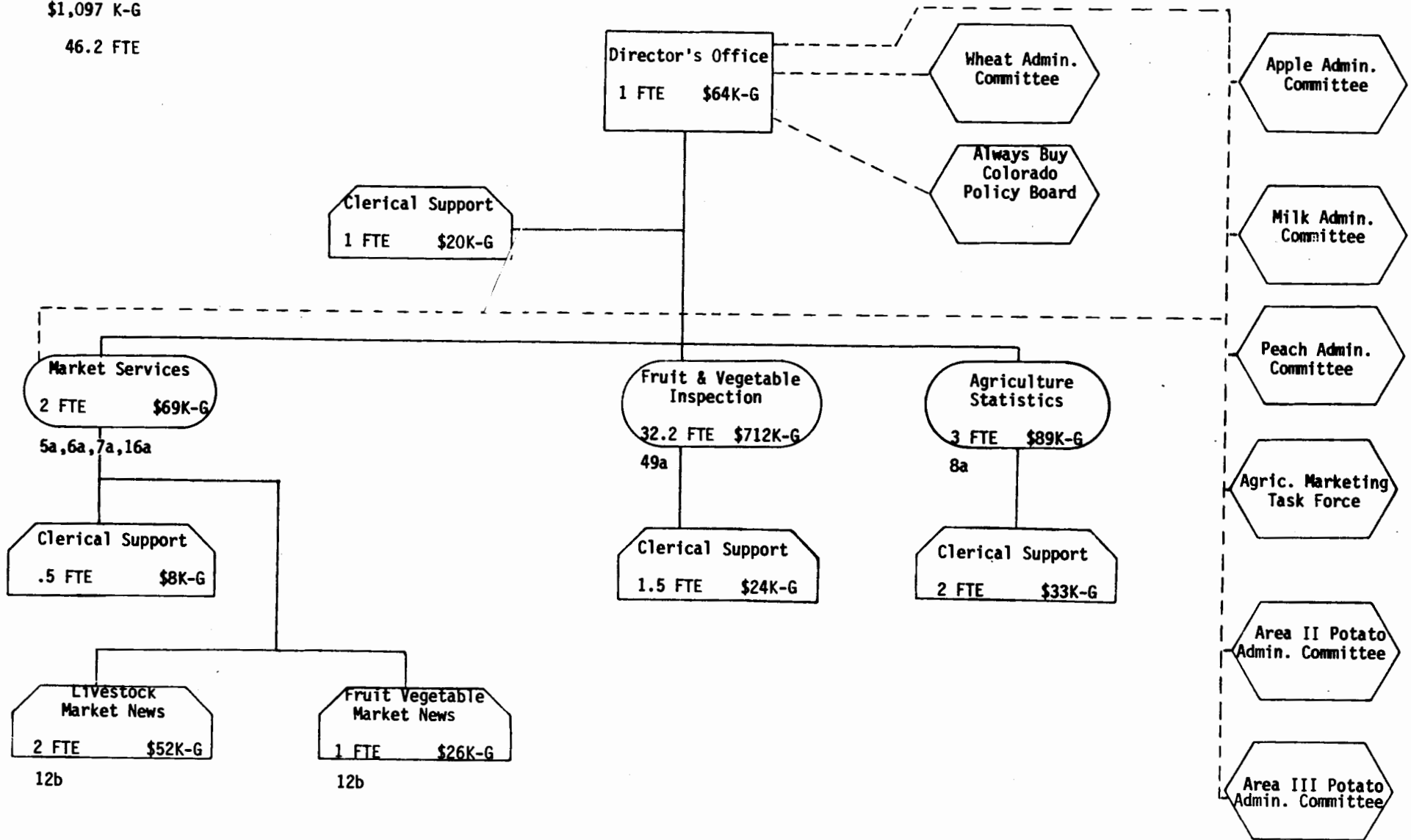

Division Totals:

\$689 K-G
\$4.5 K-C

23 FTE

PLANTS INDUSTRY DIVISION

Director's Office
\$70.5K-G
1 FTE \$2K-C

Clerical Support
1 FTE \$21K-G

Nursery & Quarantine Section
1 FTE \$39K-G

Biological Pest Control
1 FTE \$38K-G

Field Support
2 FTE \$65K-G
29a, 51a, 52a, 58a

Clerical Support
1 FTE \$16K-G

Peach Mosaic
.5 FTE \$2.5K-C
23a

Clerical Support
.5 FTE \$6K-G

Field Support
4 FTE \$123K-G
26a, 27a, 28a

Pesticide/ Application
1 FTE \$36K-G

Seed, Apiary & Pest District
1 FTE \$34K-G

Clerical Support
2 FTE \$35K-G

Field Support
4 FTE \$99K-G
59a, 63a, 66a

Clerical Support
1 FTE \$20K-G

Field Support
2 FTE \$85K-G
30a, 31a, 53a, 55a

Nursery Advisory Committee

Pesticide/ Application Advisory Committee

Structural Pest Control Advisory Committee

Seed Advisory Committee

Beekeeper Advisory Committee

AG-18

DEPARTMENT OF CORRECTIONS

Page

Administers State Correctional Facilities

Inmate Care and Supervision.....	C0-1
Parole Administration.....	C0-2
Program Development and Administration.....	C0-3

Provides Internal Management
and Support Services

Facilities Maintenance.....	C0-5
Financial Affairs.....	C0-6
Management and Supervision.....	C0-7
Personnel Services.....	C0-8

DEPARTMENT OF CORRECTIONS

Administers State Correctional Facilities

Inmate Care and Supervision

1. Establishes programs and facilities as an alternative or as a supplement to the state penitentiary and state reformatory for the custody and treatment of offenders. (Office of Executive Director; 17-27-106 (1), C.R.S. 1973)
2. Provides in-house medical and dental services for offenders and purchases such outside services as are needed to supplement the department's resources. (Office of the Executive Director, Medical/Mental Health Unit, Division of Adult Services, all facilities; 17-1-101 (2), C.R.S. 1973)
3. Provides diagnostic examination and evaluation of all offenders sentenced by the courts of the state. (Division of Adult Services, Diagnostic Program; 17-40-102 (2), C.R.S. 1973)
4. Provides counseling, guidance planning and monitoring and case recording. (Divisions of Adult Services and Community Services, all facilities and Office of Executive Director, Offender Services Unit; 17-1-101 (2), C.R.S. 1973)
5. Provides mental health services for offenders and purchases mental health services to supplement in-house resources. (Office of Executive Director, Medical/Mental Health Unit, Divisions of Adult Services and Community Services, except Bails Hall and Ft. Logan; 17-1-101, C.R.S. 1973)
6. Periodically reviews each inmate's security designation and facility assignment, and approves initial and revised performance plans; administers segregation hearings and inmate housing and job assignments. (Divisions of Adult Services and Community Services, all facilities and Office of Executive Director, Offender Services Unit; 17-1-101 (2), C.R.S. 1973)
7. Provides three meals daily for all inmates and for staff as required. (Division of Adult Services, Food Services Section, and all facilities, Division of Community Services, all facilities; 17-1-101 (2), C.R.S. 1973)
8. Monitors inmate hygiene and clothing issue, telephone calls, pass issuance, cleanliness of inmate cellhouse or dormitory unit and disciplinary reports, and notifies appropriate facility staff of problems or unusual offender behavior. (Divisions of Adult Services and Community Services, all facilities; 17-1-101 (2), C.R.S. 1973)

9. Provides sanitary items related to food service, inmate clothing and bedding. (Divisions of Adult Services and Community Services, Laundry Section, and all facilities; 17-1-101 (2), C.R.S. 1973)
10. Provides inmates with library services. (Divisions of Adult Services and Community Services, all facilities; 17-1-101 (2), C.R.S. 1973)
11. Maintains inmate information dealing with location, status, movement, security designation and identification. (Divisions of Adult Services and Community Services, all facilities; 17-1-101 (1), C.R.S. 1973)
12. Supervises and conducts religious services for inmates. (Divisions of Adult Services and Community Services, all facilities; 17-1-101 (1), C.R.S. 1973)
13. Arrests or causes to be arrested and taken to court any person who breaks the peace or commits a crime on the grounds of the state penitentiary. (Divisions of Adult Services and Community Services, all facilities; 17-20-103, C.R.S. 1973)

Parole Administration

14. Administers the adult parole program. (Division of Community Services, all facilities except Delta, Rifle and the Colorado Corrections Center; 17-2-102 (1), C.R.S. 1973)
15. Appoints officers and employees as needed to supervise all adult parolees released from state penal or correctional institutions together with such other persons as are accepted for supervision under interstate compacts. (Division of Community Services, all facilities except Delta, Rifle and the Colorado Corrections Center; 17-2-102 (2) and (3), C.R.S. 1973, and Section 13, Article XII, Colorado State Constitution)
16. Maintains a clearinghouse for information on domestic as well as interstate parolees and prepares such forms, records and reports as the executive director may require. (Division of Community Services all facilities, except Delta, Rifle and the Colorado Corrections Center; 17-2-104 (1), C.R.S. 1973)

17. Promulgates rules and regulations governing the granting and revocation of parole from the state penitentiary, the Colorado state reformatory, and other state penal and correctional institutions where adult offenders are confined. (State Parole Board; 17-2-201 (3) (a), C.R.S. 1973)
18. Locates and returns parole absconders. (Office of Executive Director, Inspection General Unit, Division of Community Services, all facilities except Delta, Rifle and the Colorado Corrections Center; 17-2-302, C.R.S. 1973)
19. Considers all applications for parole from the state penitentiary, the Colorado state reformatory, and other adult correctional institutions, as well as all persons to be supervised under any interstate compact. (State Parole Board; 17-2-201 (3) (b) through (d), C.R.S. 1973)
20. Conducts hearings when necessary regarding the revocation of parole. (State Parole Board; 17-2-103, and 17-2-201 (3) (e), C.R.S. 1973)
21. In regard to parole proceedings, issues warrants and subpoenas, appoints hearing officers, administers oaths and takes the testimony of persons under oath. (State Parole Board; 17-2-201 (8), C.R.S. 1973)
22. Deputizes persons regularly employed by the state or any person regularly employed by another state, to act as an officer and agent in effecting the return of any person who has violated terms and conditions of parole or probation granted by this state. (Divisions of Adult Services and Community Services, all facilities; 17-2-302, C.R.S. 1973)
23. Brings to the consideration of the state board of parole the matter of parole of every person sentenced or committed to the Colorado state reformatory, furnishing the board with a report and recommendation as to whether such person should be paroled. (Divisions of Adult Services and Community Services, all facilities; 17-22-103 (1), C.R.S. 1973)

Program Development and Administration

24. Provides self-supporting and profit-oriented programs which utilize inmate labor and develop skills. (Division of Correctional Industries, Director, Operations Section; 17-24-106 (1) (a) through (c); C.R.S. 1973)
25. Acquires or purchases equipment, raw materials, supplies, office space, insurance, services and supervisory personnel necessary for the establishment and maintenance of programs

- at the state's correctional institutions. (Division of Correctional Industries, Director, Operations Section; 17-24-106 (1) (d), C.R.S. 1973)
26. Utilizes the labor services of prisoners in the production of goods and services that are needed for the construction, operation, or maintenance of any agency supported in whole or in part by the state, political subdivision of the state, or federal government. (Division of Correctional Industries, Director, Operations Section; 17-24-106 (1) (e), C.R.S. 1973)
 27. Develops industries within the state's correctional institutions which have a rehabilitative or therapeutic value for inmates. (Office of Executive Director, 17-1-103 (1) (f), C.R.S. 1973)
 28. Sells goods and services, including capital construction items, produced by prison labor programs to agencies supported in whole or in part by the state, any political subdivision of the state, or the federal government. (Division of Correctional Industries, Director, Operations Section; 17-24-106 (1) (f), C.R.S. 1973)
 29. Details convicts to work on public roads and highways of the state or any county or municipality as requested by county commissioners. (Divisions of Adult Services and Community Services, all facilities except Ft. Logan and Bails Hall; 17-20-116, C.R.S. 1973)
 30. Purchases equipment, machinery, and other materials necessary to manufacture and deliver motor vehicle license plates, validating tabs or decals, road signs, markers, and metal badges used by any state department. (Division of Correctional Industries, Director's Office; 17-24-109.5 (1), C.R.S. 1973)
 31. Fixes and determines the prices at which all prison labor is performed and at which all goods and services produced are sold. (Division of Correctional Industries, Director's Office; 17-24-112 (1), C.R.S. 1973)
 32. Prepares catalogues containing the description of all prison goods and services produced with the price of each item. (Division of Correctional Industries, Marketing Section; 17-24-112 (2), C.R.S. 1973)
 33. Makes all offender work assignments. (Divisions of Adult Services and Community Services, all facilities; 17-24-114 (1), C.R.S. 1973)
 34. Establishes the rate of compensation for the offenders working in each program. (Director, Division of Management and Development; 17-24-114 (2), C.R.S. 1973)

35. Makes rules and regulations regarding the method and time of compensation payments. (Director, Division of Management and Development; Director, Division of Adult Services; 17-24-114 (2), C.R.S. 1973)
36. Grants good time allowances and furloughs based upon an offender's work performance evaluation. (Division of Adult Services Director; 17-24-114 (3), C.R.S. 1973)
37. Establishes rules and regulations governing the employment, conduct, and management of offenders while assigned to programs. (Divisions of Adult Services and Community Services, all facilities, Office of the Executive Director; 17-24-114 (4), C.R.S. 1973)
38. Contracts for services with local governments or non-governmental agencies operating community correctional facilities or programs. (Office of Executive Director; 17-27-106 (2), C.R.S. 1973)
39. Establishes and enforces standards and regulations for all state-operated correctional facilities and programs, and sees that community correctional facilities or programs operated by units of local government or non-governmental agencies meet approved minimum standards. (Office of Executive Director; 17-27-106 (3), C.R.S. 1973)
40. Administers diagnostic services and supervises employees involved in the program. (Division of Adult Services, Diagnostic Section; 17-40-106 (1), C.R.S. 1973)
41. Administers educational programs for inmates. (Division of Adult Services, Vocational Education and Program Services Sections; no state statutory mandate).

Provides Internal Management and Support Services

Facility Maintenance

42. In consultation with division directors and superintendents, develops a systematic building program providing for projected long-range institutional needs. (Office of Executive Director, Planning Section, all Divisions; 17-1-103 (1) (c), C.R.S. 1973)
43. Classifies the lands connected with the state's correctional institutions, determining which are of such character as to be most profitably used for agriculture. (Office of Executive Director, Division of Correctional Industries, Director's Office; 17-1-103 (1) (d), C.R.S. 1973)

44. Calls upon the staff and services of other state agencies and departments, to assist in carrying out the purpose of the department. (Office of Executive Director; 17-1-103 (1) (e), C.R.S. 1973)
45. Establishes and administers programs regarding physical plant and facility maintenance, and food and laundry services for each of the state's correctional institutions. (Divisions of Adult Services and Community Services, all facilities, Office of Executive Director, Planning Section; 17-24-109 (1), C.R.S. 1973)
46. Coordinates the management, control, regulation and operation of the physical facilities and the reception, discipline, and confinement of all offenders. (Office of the Executive Director, Planning Unit and Divisions of Adult Services and Community Services, all facilities; 17-40-106 (2), C.R.S. 1973)
47. Administers overall facility planning, policy and procedures development, staff and inmate supervision, and organizational and coordination functions associated with daily operations of inmate facilities. (Divisions of Adult Services and Community Services, all facilities; 17-1-101 (2), C.R.S. 1973)
48. Plans, directs, coordinates and evaluates the resources of each correctional facility. (Divisions of Adult Services and Community Services, all facilities; 17-1-101 (2), C.R.S. 1973)
49. Maintains the interior and grounds of correctional facilities. (Division of Adult Services, Maintenance Services Section; no state statutory mandate).
50. Maintains and operates security systems and all necessary and emergency communications systems. (Division of Management and Development, Business Operations Section, Communications Unit; no state statutory mandate).

Financial Affairs

51. Supervises the business, fiscal, budget, personnel, and financial operations of the department and the institutions under its control. (Director, Division of Management and Development; 17-1-103 (1) (b), C.R.S. 1973)
52. Reports annually to the executive director on the operation of the canteen and library fund. (Director, Division of Management and Development; 17-22-109, C.R.S. 1973)
53. Purchases, leases, trades, exchanges or otherwise acquires, maintains and disposes of real property and personal

property and any interest therein. (Director, Division of Management and Development, Purchasing Unit; 17-24-106 (1) (k), C.R.S. 1973)

54. Makes regular reports, including monthly operating statements and annual financial reports, to the Governor, the Joint Budget Committee, and the Office of State Planning and Budgeting. (Director, Division of Management and Development, Management Information System, Business Operations, Fiscal Liason Sections; 17-24-113 (6), C.R.S. 1973)
55. Handles internal auditing including the auditing of grants and the finances of the executive director's office. (Office of Executive Director, Internal Auditor Unit; 17-1-107, C.R.S. 1973)
56. Handles all obligating authority, fiscal projections and/or case flow adjustments, responds to fiscal questions from external agencies, and approves all fiscal information released by the department. (Director, Division of Management and Development, Management Information System, Business Operations, Fiscal Liason Sections; 17-1-103 (1) (b), C.R.S. 1973)
57. Administers accounting, budgeting, payroll, inventory and supply, purchasing, inmate banking and contracting for the department. (Division of Management and Development, Management Information System, Business Operations, Fiscal Liason Sections; 17-1-103 (1) (b), C.R.S. 1973)
58. Coordinates all purchasing and warehouse operations. (Division of Management and Development, Director's Office and Business Operations, , Purchasing and Warehouse Units; 17-1-103 (1) (b), C.R.S. 1973)

Management and Supervision

59. Prepares and transmits annually a report to the Governor and the General Assembly accounting for the efficient discharge of all responsibilities assigned by law or directive to the department. (Director, Division of Management and Development, Management Information System, Business Operations, Fiscal Liason Sections; 17-1-103 (1) (g) C.R.S. 1973)
60. Manages, supervises and controls the penal, correctional and reformatory institutions operated and supported by the state. (Office of Executive Director; 17-1-103 (1) (a), C.R.S. 1973)

61. Exercises control over publications of the department. (Office of Executive Director; 17-1-103 (1) (h), C.R.S. 1973)
62. Submits an annual report to the executive director containing such information and at such time as the executive director shall decide. (Director, Division of Management and Development; 17-1-103 (1) (g), C.R.S. 1973)
63. Provides advice and technical assistance to local corrections boards. (Office of Executive Director; 17-27-109, C.R.S. 1973)
64. Administers all automated information systems used by the department. (Director, Division of Management and Development; 17-1-103 (1) (b), C.R.S. 1973)

Personnel Services

65. Investigates incidents occurring in the department involving criminal matters, escapes, and staff improprieties. (Office of Executive Director, Inspection General Unit; 17-1-101, C.R.S. 1973)
66. Sees that affirmative action mandates are adhered to at all levels. (Office of Executive Director, Affirmative Action Section; 17-1-101, C.R.S. 1973)
67. Administers staff recruitment, selection, personnel classification and grievance resolution. (Division of Management and Development, Personnel Operations Section, Colorado Springs, Canon City, Buena Vista; 17-1-101, C.R.S. 1973)
68. Develops and coordinates policies and procedures of the decentralized facility personnel operations and serves as a liaison with the Department of Personnel. (Director, Division of Management and Development, Personnel Operations Section, Colorado Springs, Canon City, Buena Vista; 17-1-103, C.R.S. 1973)
69. Provides staff training for department personnel. (Director, Division of Management and Development, Personnel Operations Section, Colorado Springs, Canon City, and Buena Vista; 17-1-101, C.R.S. 1973)

Department Totals:

\$50,584 K-G

1,083 FTE

DEPARTMENT OF CORRECTIONS

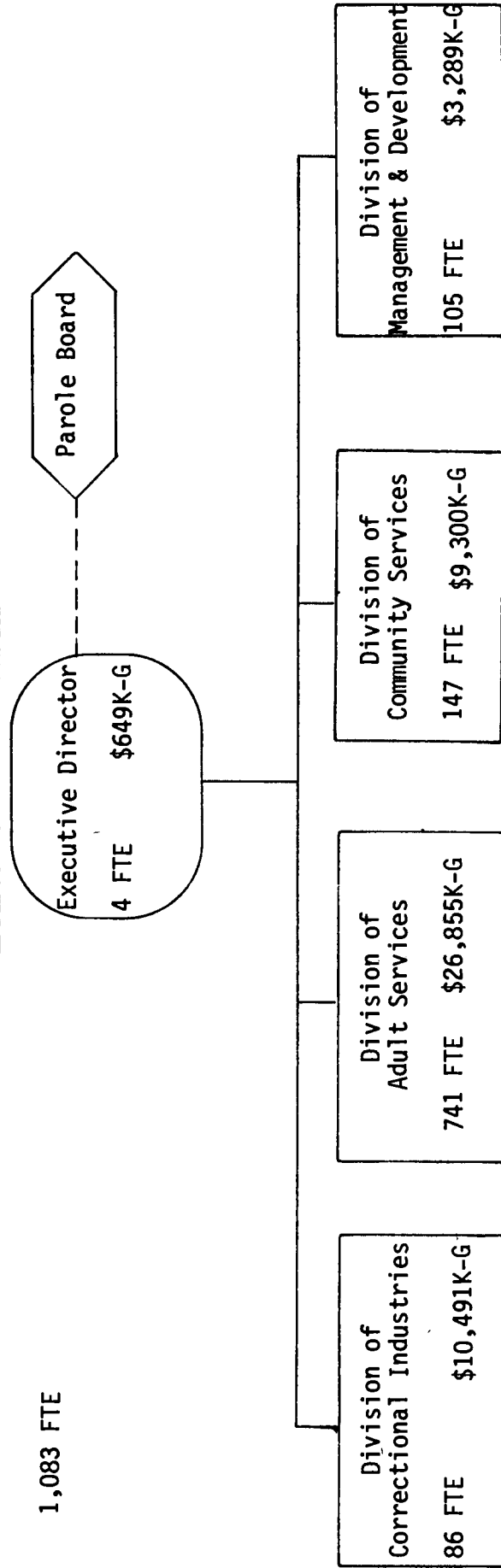

Total: \$5,164 K-G
118.8 FTE

OFFICE OF THE EXECUTIVE DIRECTOR

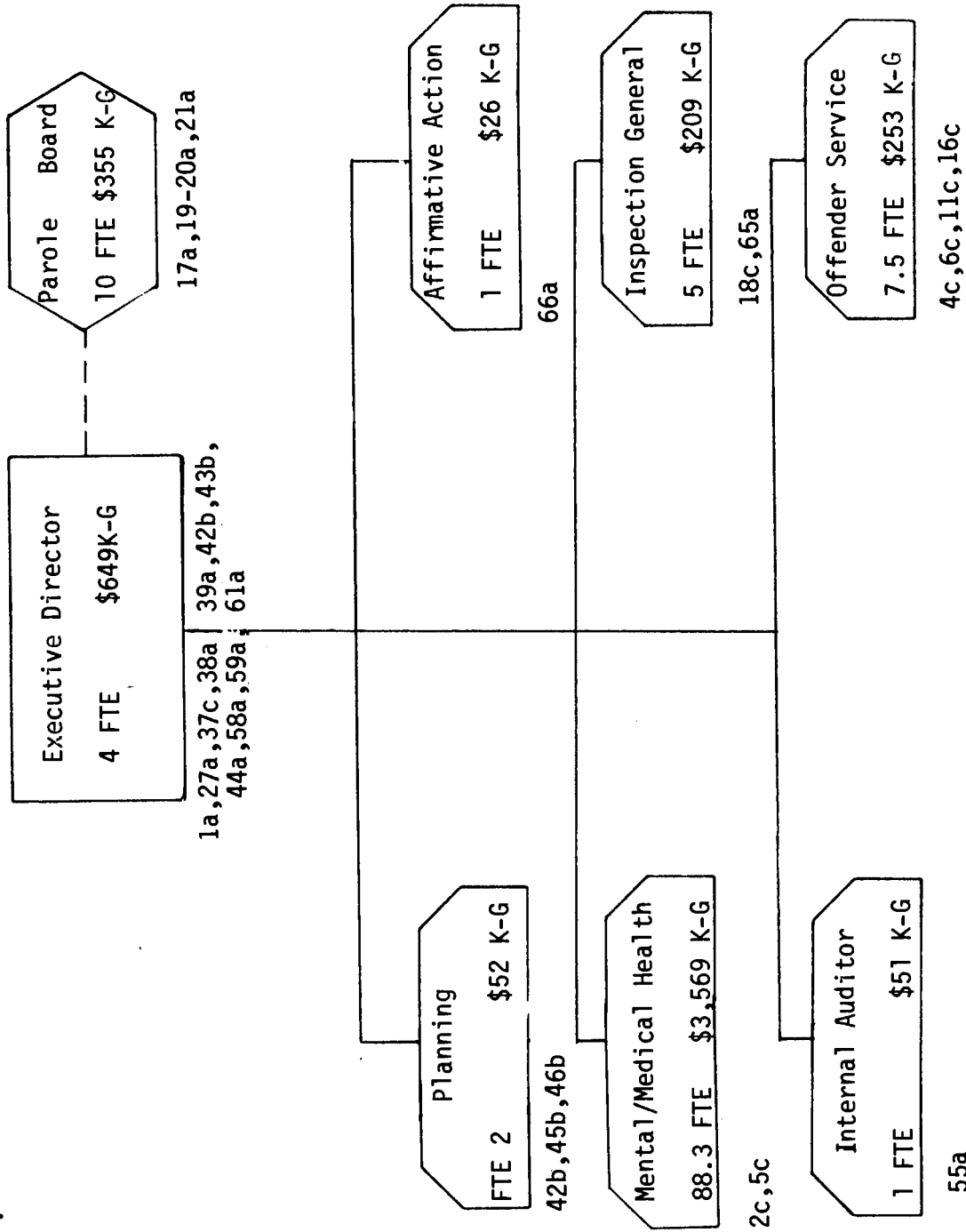

\$26,855 K-G

741 FTE

DIVISION OF ADULT SERVICES

CO-11

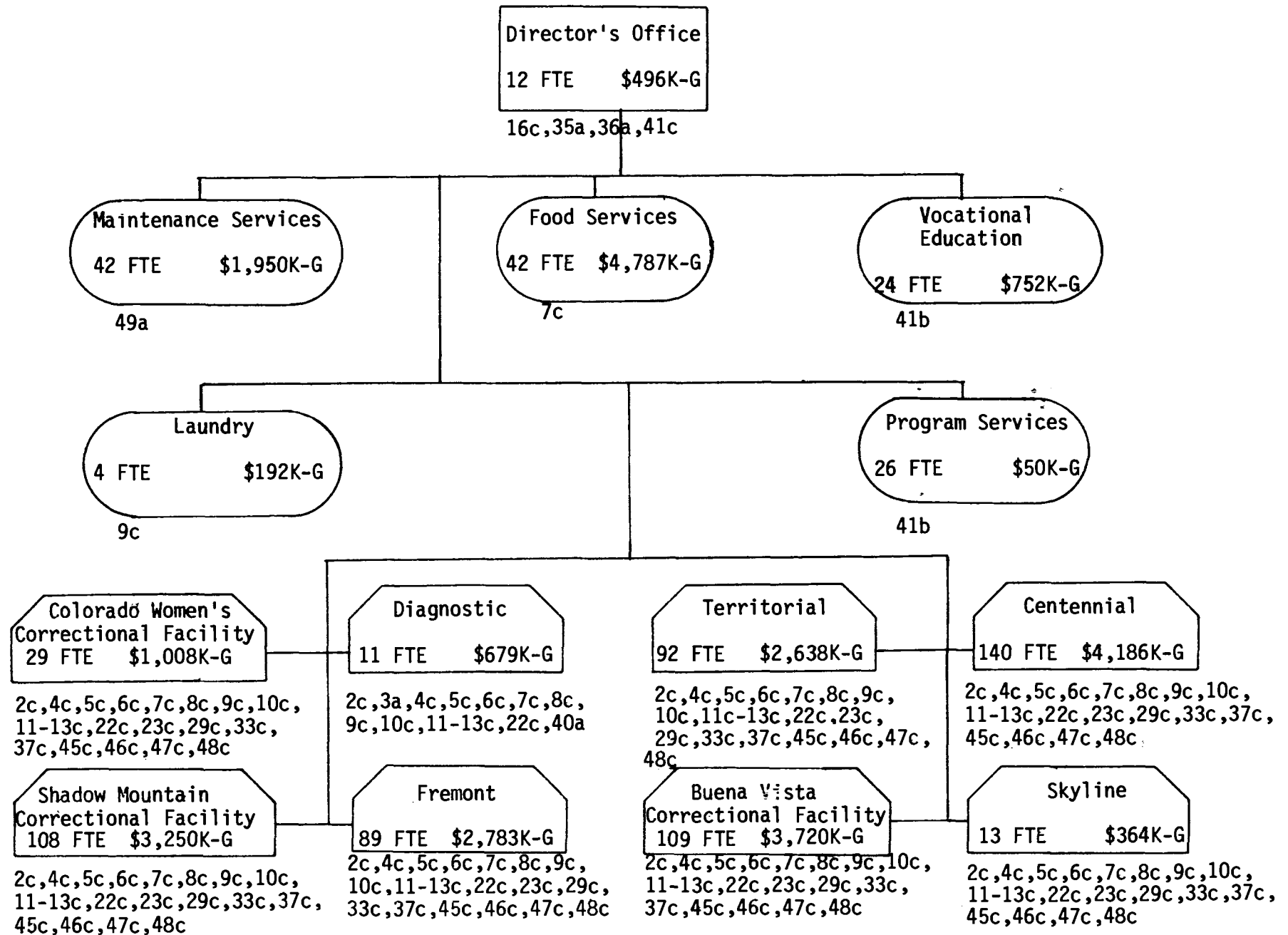

Totals: \$9,300 K-G
147.5 FTE

DIVISION OF COMMUNITY SERVICES

Director's Office
4 FTE \$108 K-G

14a,15a,16c,18c,42c

Community Placement Services
2 FTE \$7 K-G

Community Transition
2 FTE \$2,018 K-G

Canon City
11 FTE \$175 K-G

Buena Vista
6.5 FTE \$157 K-G

Denver Regional Office
\$1,012 K-G

N.W. Regional Office
\$880 K-G

S.W. Regional Office
\$288 K-G

Western Regional Office
\$1,237 K-G

Bails Hall Community Facility
9 FTE \$235 K-G

Colorado Corrections Center
17 FTE \$418 K-G

Field Services, Colo. Spgs.
5.5 FTE \$152 K-G

Delta Honor Camp
17 FTE \$511 K-G

Ft. Logan Community Facility
9 FTE \$232 K-G

Field Services
17 FTE \$462 K-G

Field Services, Pueblo
5 FTE \$136 K-G

Rifle Honor Camp
17 FTE \$546 K-G

Special Services
2 FTE \$70K-G

Field Services
6.5 FTE \$181K-G

Field Services
17 FTE \$475K-G

4c,6c,7c,8c,9c,10c,11-16c,18c,22c,23c,33c,37c,45-48c

4c,5c,6c,7c,8c,9c,10c,11-13c,22c,23c,29c,33c,37c, 45-48c

4c,5c,6c,7c,8c,9c,10c,11-13c,22c,23c,29c,33c,37c, 45-48c

4c,6c,7c,8c,9c,10c,11-16c,18c,22c,23c,33c,37c, 45-48c

4c,5c,6c,7c,8c,9c,10c,11-13c,22c,23c,29c,33c,37c, 45-48c

CO-12

DIVISION OF CORRECTIONAL INDUSTRIES

Division Totals:
\$10,491 K-G

86 FTE

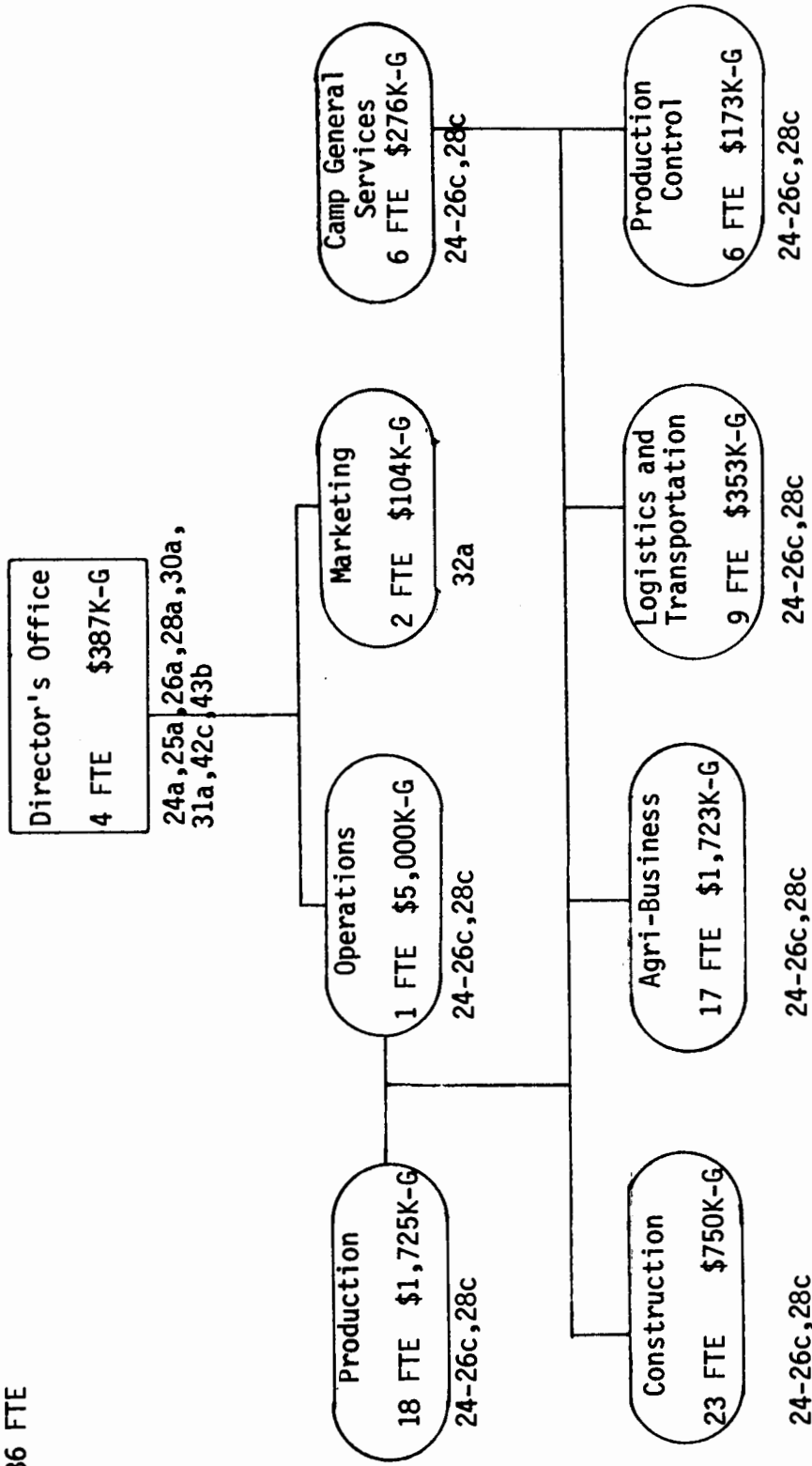

Division Totals:

\$3,289 K-G

105 FTE

DIVISION OF MANAGEMENT AND DEVELOPMENT

Director's Office
6 FTE \$262K-G

34a, 35a, 42c, 51a, 52a, 53b, 54b, 56c,
57c, 58c, 59c, 62a, 64a, 68-69c

Personnel Operations
7 FTE \$215K-G

67-69c

Management Information Systems
10 FTE \$371K-G

54c, 56c, 57c, 59c

Staff Training
12 FTE \$379K-G

Business Operations
42 FTE \$1,231K-G

54c, 56c, 57c, 59c

Fiscal Liaison
5 FTE \$168K-G

54c, 56c, 57c, 59c

Colorado Springs
2 FTE \$96K-G

67-69c

Canon City
3 FTE \$64K-G

67-69c

Buena Vista
2 FTE \$55K-G

67-69c

Warehouse
10 FTE \$277K-G

58c

Purchasing
4 FTE \$136K-G

53b, 58c

Communications
2 FTE \$35K-G

50a

CO-14

DEPARTMENT OF EDUCATION

Coordinates and Oversees the Funding and
Operation of Education Programs

	<u>Page</u>
Coordinates Educational Programs.....	ED-1
Disburses Funds.....	ED-2
Evaluates and Approves Educational Programs.....	ED-2
Facilitates Intergovernmental Relations.....	ED-4
Maintains Internal Staffing Services.....	ED-5
Performs Research and Analysis Services and Distributes Information	
Information Gathering and Publication.....	ED-6
Research on Educational Topics.....	ED-8
Provides Advisory, Technical and Consultative Services to School Districts	
Program Execution.....	ED-8
School Administration.....	ED-9
Educational and Other Related Services for Public Libraries and Other Entities.....	ED-11
Special Educational Programs and Other Related Services.....	ED-12

DEPARTMENT OF EDUCATION

Coordinates and Oversees the Funding and
Operation of Education Programs

Coordinates Educational Programs

1. Supervises, manages and controls the Colorado School for the Deaf and the Blind. (Office of the Commissioner, Colorado School for the Deaf and the Blind; 22-2-112 (1) (m), C.R.S. 1973)
2. Coordinates various youth and teacher programs and activities. (Office of the Commissioner, Public Affairs; no state statutory mandate)
3. Coordinates state and local resources to support adult basic education services. (Office of Field Services, Community Based Education Services; no state statutory mandate)
4. Assists in organizing resources to implement school improvement processes. (Office of Field Services, Community Based Education Services, and Office of Program Development, School Improvement and Leadership Services; no state statutory mandate)
5. Administers the national school lunch program in Colorado. (Office of Field Services, Nutrition/Energy/Traffic; 22-32-120, C.R.S. 1973)
6. Works to improve the efficiency and economy of food service operations. (Office of Field Services, Nutrition/Energy/Traffic; no state statutory mandate)
7. Administers the Exceptional Children's Educational Act. (Office of Department Management Services, Special Education Services; 22-20-104 (1), C.R.S. 1973)
8. Appoints a commissioner of education. (State Board of Education; 22-2-106 (1) (b), C.R.S. 1973)
9. Oversees the education of handicapped children in state institutions. (Office of Department Management Services, Special Education; no state statutory mandate)
10. In cooperation with the Department of Health, coordinates the state-mandated health education program for schools with other agencies and with interested organizations. (Office of Program Development, Special Projects; 22-25-104 (1), C.R.S. 1973)

Disburses Funds

11. Approves annual budget requests of the general assembly and orders the distribution or apportionment of federal and state moneys to school districts. (State Board of Education; 22-2-106 (1) (d) and (e), C.R.S. 1973)
12. Processes applications for retirement benefits and authorizes payments from the Teachers' Emeritus Retirement Fund. (Office of the Commissioner, Personnel Services; 22-64-117 and 22-64-119, C.R.S. 1973)
13. Apportions federal moneys granted or appropriated to the department for the use of the public schools. (Office of the Commissioner, Federal Relations; 22-2-106 (1) (e), C.R.S. 1973)
14. Acquires and disseminates information concerning federal grants, regulations and legislation to school districts, boards of cooperative services, educational organizations and the department staff. (Office of the Commissioner, Federal Relations; no state statutory mandate)
15. Develops the annual budget request plan for submission to the state board, executes the approved budget and monitors its implementation. (Office of Department Management Services, Planning and Evaluation; 22-2-106 (1) (d) and 22-2-112 (1) (c), C.R.S. 1973)
16. Distributes state funds pursuant to the Public School Finance Act, Public School Transportation Fund and Exceptional Children's Educational Act; administers these laws. (Office of Department Management Services, School Finance Distribution and Special Education Services; Articles 20, 50 and 50 of Title 22, C.R.S. 1973)
17. Prepares, approves and implements plans necessary as a prerequisite to the receipt of federal funding or property; administers federal moneys granted or appropriated to the department for the use of the public schools. (Office of the Commissioner, Federal Relations, and Office of Program Development, Special Projects; 22-2-106 (1) (e), and 22-2-107 (1) (i), and 22-2-108, C.R.S. 1973)

Evaluates and Approves Educational Programs

18. Accredits public schools; reports on the accreditation status of school districts to the governor and the general assembly and withholds accreditation from districts not complying with the state's accountability law. (State Board of Education, and Office of Program Development, School Improvement and Leadership Services; 22-2-106 (1) (c), (2), and (3), C.R.S. 1973)

19. Accredits, upon request, nonpublic schools. (State Board of Education, and Office of Program Development, School Improvement and Leadership Services; 22-2-107 (1) (g), C.R.S. 1973)
20. Develops and approves techniques and instruments to be used in identifying students eligible for English language proficiency assistance. (Office of the Commissioner, English Language Proficiency; 22-24-106, C.R.S. 1973)
21. Audits the identification and testing procedures for English language proficiency programs used by districts and evaluates the effectiveness of the programs conducted by districts. (Office of the Commissioner, English Language Proficiency; 22-24-106, C.R.S. 1973)
22. Develops a statewide linkage network to support the accreditation and accountability processes. (Office of Field Services, Community Based Education Services; no state statutory mandate)
23. Establishes requirements for high school equivalency certificates and issues certificates to those who qualify for equivalency diplomas. (Office of Field Services, Community Based Education Services; 22-2-112 (2), C.R.S. 1973)
24. Approves special education programs and state reimbursements for a certain portion of their costs. (Office of Department Management Services, Special Education Services; 22-20-114, C.R.S. 1973)
25. Issues teaching certificates and renewal of teaching certificates for persons meeting the requirements of state law and the state board. (Office of Program Development, Teacher Education and Certification; 22-60-104 (1) and (2), C.R.S. 1973)
26. Annuls certificates or letters of authorization granted through misrepresentation or fraud. (Office of Program Development, Teacher Education and Certification; 22-60-110 (1), C.R.S. 1973)
27. Administers the in-service training programs for recertification credit. (Office of Program Development, Teacher Education and Certification; no state statutory mandate)
28. Works with representatives from all levels of education to develop standards of qualification, preparation and experience for all certificates, letters of authorization and endorsements. (State Board of Education and Office of Program Development, Teacher Education and Certification; 22-2-109 (1) (i), C.R.S. 1973)

29. Approves teacher education classes and programs offered in Colorado by institutions of higher education from outside of Colorado. (State Board of Education and Office of Program Development, Teacher Education and Certification; 22-2-109 (1) (k), C.R.S. 1973)
30. Evaluates and approves programs of teacher preparation in Colorado institutions of higher education. (State Board of Education and Office of Program Development, Teacher Education and Certification; 22-2-109 (1) (e), C.R.S. 1973)

Facilitates Intergovernmental Relations

31. Executes agreements with federal agencies or officers as a condition to receiving federal moneys. (Office of the Commissioner, Federal Relations and Office of Program Development, Special Projects; 22-2-108 (2), 22-2-107 (1) (i) and 22-2-108 (2), C.R.S. 1973)
32. Works at improving public school and state interagency coordination of federal programs. (Office of the Commissioner, Federal Relations; no state statutory mandate)
33. Investigates and resolves complaints filed with the department regarding federally-funded programs. (Office of the Commissioner, Federal Complaints Officer; no state statutory mandate)
34. Participates in the creation, drafting and revision of legislation affecting public education and provides information to the general assembly regarding public education. (Office of the Commissioner, State Governmental Relations and Offices of Field Services, Library Services, Management Services and Program Development; no state statutory mandate)
35. Reports to the general assembly on the effectiveness of the state's English language proficiency program. (Office of the Commissioner, English Language Proficiency; 22-24-106, C.R.S. 1973)
36. Adopts and promulgates rules concerning educational programs maintained and operated by all state governmental agencies for persons who have not completed the twelfth-grade level of instruction. (Office of Field Services, Community Based Education Services; 22-2-107 (1) (c), C.R.S. 1973)
37. Audits school districts regarding state programs to maintain compliance with the state statutes and state board rules. (Office of Department Management Services,

Accounting and Auditing; 22-45-107 and 29-1-603 (1), C.R.S. 1973)

38. Assists the commissioner, state board and other agencies in conducting activities leading to improved services or new program development. (Office of Program Development, School Improvement and Leadership Services; no state statutory mandate)
39. Provides management supervision and guidance in the coordination of federal program information and services delivery to local school districts. (Office of Program Development, Special Projects; no state statutory mandate)
40. Analyzes and presents Colorado concerns and reactions to proposed federal programs, rules and enactments. (Office of the Commissioner, Federal Relations; no state statutory mandate)
41. Provides information on legislation to school districts and other interested parties. (Office of the Commissioner, State Governmental Relations and Offices of Field Services, Library Services, Management Services and Program Development; no state statutory mandate)

Maintains Internal Staffing Services

42. Establishes and maintains a system of personnel, organization and administration within the department. (Office of the Commissioner and Personnel Services Section; 22-2-107 (1) (e), C.R.S. 1973)
43. Provides department support services. (Office of Department Management Services, Administrative Support and Technical Services; no state statutory mandate)
44. Provides staff assistance to the State School District Budget Review Board. (Office of Department Management Services; School Finance Distribution; 22-50-107, C.R.S. 1973)
45. Staffs an education advisory committee. (Office of Department Management Services, Special Education Services; 22-20-104 (2), C.R.S. 1973)
46. Provides personnel, facilities and data to the educational accountability advisory committee. (Office of Program Development, School Improvement and Leadership Services; 22-7-103 (6), C.R.S. 1973)
47. Maintains a central accounting system and budget monitoring system. (Office of Department Management Services, Accounting and Auditing; no state statutory mandate)

48. Establishes a salary schedule for those personnel not covered by the state's personnel system for approval by the state board. (Office of the Commissioner/Personnel Services; 22-2-107 (1) (d), C.R.S. 1973)
49. Approves a salary schedule for department personnel not covered by the state's personnel system. (State Board of Education; 22-2-107 (1) (d), C.R.S. 1973)
50. Assists in adoption and promulgation of state board rules. (Office of the Commissioner, State Governmental Relations and Offices of Field Services, Library Services, Management Services and Program Development; 22-2-107 (1) (c), C.R.S. 1973)
51. Advises the State Board of Education on the current operation and status of the public schools and serves the board in exercising general supervision over the public schools of the state. (Office of Field Services, Office of Management Services, Planning and Evaluation and Office of Program Development, School Improvement and Leadership Services; 22-2-106 (1) (a), and 22-2-112 (1) (a), C.R.S. 1973)
52. Advises the state board concerning the current operation and status of the public schools and other educational matters. (Office of Field Services; 22-2-112 (1) (a), C.R.S. 1973)
53. Provides an analysis of the department management services. (Office of Department Management Services, Administrative Support and Technical Services; no state statutory mandate)
54. Conducts departmental policy studies. (Office of Department Management Services, Planning and Evaluation; no state statutory mandate)

Performs Research and Analysis Services and Distributes Information

Information Gathering and Publication

55. Informs the public of the priorities and directions of the State Board of Education and of the Department of Education and responds to inquiries. (Office of the Commissioner, Public Affairs; no state statutory mandate)
56. Assists in issuing all publications of the department circulated in quantity outside the executive branch. (Office of the Commissioner, Public Affairs; 22-2-112 (1) (b), C.R.S. 1973)

57. Collects required reports prepared by school districts. (Office of Department Management Services, Administrative Support and Technical Services; 22-2-107 (1) (m), C.R.S. 1973)
58. Prescribes forms and items to be included in reports submitted by school districts and maintains statistical and financial records of school districts. (Office of Department Management Services, Administrative Support and Technical Services and Special Education Services; 22-2-113 (1) (c), and 22-2-112 (1) (c) and (h), C.R.S. 1973)
59. Prepares the consolidated report on school districts for annual distribution to the governor and the general assembly. (Office of Department Management Services, Administrative Support and Technical Services; 22-2-112 (1) (k), C.R.S. 1973)
60. Prepares information as to the condition of education in the state and publishes the annual status report. (Office of Department Management Services, Planning and Evaluation; 22-2-106 (1) (f), and 22-2-112 (1) (a) and (b), C.R.S. 1973)
61. Evaluates and publishes reports on teacher preparation programs. (Office of Department Management Services, Planning and Evaluation, also Office of Program Development Teacher Education and Certification; 22-2-109 (1) (b), C.R.S. 1973)
62. Collects and holds plans containing the types and numbers of handicapped children, services to be provided and the estimated resources. (Office of Department Management Services, Special Education Services; 22-20-106 (2), C.R.S. 1973)
63. Develops an annual special education report and maintains a data and information system on children, personnel, costs and revenues from which to prepare the report. (Office Of Department Management Services, Special Education Services; 22-20-104 (3) and (4), C.R.S. 1973)
64. Provides conservation materials to supplement and complement existing instruction in conservation education. (Office of Program Development, School Improvement and Leadership Services; no state statutory mandate)
65. Evaluates and publishes reports on teacher preparation programs in Colorado institutions of higher education. (Office of Program Development, Teacher Education and Certification; 22-2-109 (1) (b), C.R.S. 1973)

Research on Educational Topics

66. Requires a school census and other reports prepared by local districts. (State Board of Education, Office of Management Services and Office of Program Development; 22-2-107 (1) (j) and (m), C.R.S. 1973)
67. Conducts or arranges for continuous research to stimulate improvements in education. (Office of Department Management Services, Planning and Evaluation; 22-2-112 (1) (h), C.R.S. 1973)
68. Conducts or arranges for research pertinent to teacher certification and teacher preparation programs in institutions of higher education. (Office of Program Development, Teacher Education and Certification; 22-2-109 (1) (j), C.R.S. 1973)

Provides Advisory, Technical and Consultative Services to School Districts

Program Execution

69. Assists in the mandate to teach the history and civil government of the State of Colorado in all the public schools of the state. (Office of the Commissioner, Public Affairs; 22-1-104 (1), C.R.S. 1973)
70. Assists local school districts in the acquisition of necessary books, educational materials, library resources and instructional equipment. (Office of Program Development, Special Projects; no state statutory mandate)
71. Provides assistance to school districts for their program evaluation. (Office of Department Management Services, Planning and Evaluation; no state statutory mandate)
72. Provides leadership and coordination in school bus driver training. (Office of Field Services, Nutrition/Energy/Traffic; no state statutory mandate)
73. Helps meet the individual needs of students and to provide continuous improvement processes for staffs through Individually Guided Education (IGE). (Office of Program Development, School Improvement and Leadership Services; no state statutory mandate)
74. Provides in-service training to local migrant education staff to assure that programs meet the special needs of migrant children. (Office of Program Development, Special Projects; no state statutory mandate)

75. Assists school personnel in the effective design of programs which use materials and resources in an integrated manner. (Office of Program Development, Special Projects; no state statutory mandate)
76. Assists school districts in developing or managing existing health programs. (Office of Program Development, Special Projects; 22-25-106, C.R.S. 1973)
77. Assists school districts in strengthening their educational programs. (Office of Program Development, School Improvement and Leadership Services and Office of Field Services; 22-7-102 (2) (c), C.R.S. 1973)
78. Aids local school districts (and other local educational agencies) in meeting the needs of low-achieving children in the basic programs of instruction: reading, language arts, mathematics. (Office of Program Development, Special Projects; no state statutory mandate)
79. Assists in the provision of appropriate special educational services through the use of federal funds. (Office of Department Management Services, Special Education Services; no state statutory mandate)
80. Supports innovative and exemplary programs in school districts. (Office of Program Development, Special Projects; no state statutory mandate)
81. Tries to influence student participation in traffic safety programs in the public schools. (Office of Field Services, Nutrition/Energy/Traffic; no state statutory mandate)

School Administration

82. Exercises general supervision over and provides consultative services to the public schools. (State Board of Education; 22-2-106 (1) (a) and 22-2-107 (1) (f), C.R.S. 1973)
83. Visits public schools to stimulate public sentiment regarding education and recommends desirable improvements in the government, financing, curriculum and instruction in the public schools. (Office of the Commissioner, Office of Field Services and Office of Program Development, School Improvement and Leadership Services; 22-2-112 (1) (g), C.R.S. 1973)
84. Interprets school laws on questions submitted by local school district officers, employees or others. (Office of Field Services, and Office of Commissioner, State Governmental Relations; 22-2-113 (1) (d), C.R.S. 1973)

85. Provides technical and administrative consultative services to the public schools and local boards of education. (Office of Field Services; 22-2-107 (1) (f), C.R.S. 1973)
86. Encourages the implementation of projects in schools as a means of improving pupils' achievement and satisfaction. (Office of Program Development, School Improvement and Leadership Services; no state statutory mandate)
87. Attempts to reduce discipline problems, attendance problems and vandalism in schools. (Office of Program Development, School Improvement and Leadership Services; no state statutory mandate)
88. Provides technical assistance to school improvement processes. (Office of Program Development, School Improvement and Leadership Services; no state statutory mandate)
89. Promotes leadership and staff development for school districts. (Office of Field Services, Community Based Education Services; no state statutory mandate)
90. Assists districts in relating anticipated costs to designated programs. (Office of Department Management Services, School Finance Distribution; 22-44-201, C.R.S. 1973)
91. Assists school districts in school finance questions and does research and analysis of school finance alternatives. (Office of Department Management Services, School Finance Distribution; no state statutory mandate)
92. Prepares simplified school election procedures in a manual, notifies local superintendents of their availability and furnishes copies upon request. (Office of Field Services; 22-2-112 (1) (1), C.R.S. 1973)
93. Provides information and services to school districts for planning facilities with better energy efficiency. (Office of Field Services, Nutrition/Energy/Traffic; no state statutory mandate)
94. Provides leadership to local school districts in instructional matters. (Office of Program Development, School Improvement and Leadership Services; Colorado Constitution, Article IX, Section 15)
95. Renders assistance to various school district committees in the development and submission of their organization plans for a new school district or plan of boundary change. (Office of Field Services; 22-30-109, C.R.S. 1973)

96. Provides technical assistance to school districts that are voluntarily implementing desegregation programs. (Office of Field Services, Equal Education Services; no state statutory mandate)
97. Encourages school districts to develop comprehensive desegregation plans which incorporate educational equity and improve the total climate for learning. (Office of Field Services, Equal Education Services; no state statutory mandate)
98. Assists local school districts in providing equal educational opportunity to students who are women and/or minorities. (Office of Field Services, Equal Education Services; no state statutory mandate)
99. Works toward improving public confidence in education. (Office of Field Services, Equal Education Services; no state statutory mandate)

Educational and Other Related Services for Public Libraries and Other Entities

100. Furnishes or contracts for library or information services to state officials and departments. (Office of Library Services; 24-90-105 (1) (c), C.R.S. 1973)
101. Provides for the collection, analysis, publication and distribution of statistics and information relevant to the operation of the state library and all other types of libraries in the state. (Office of Library Services; 24-90-105 (1) (h), C.R.S. 1973)
102. Develops and establishes an automated catalog system, compatible with the library of congress system, for use by all publicly supported libraries in the state. (Office of Library Services; 24-90-118 (1), C.R.S. 1973)
103. Provides for the supplying of consultative assistance and information to all types of publicly-supported libraries in the state. (Office of Library Services; 24-90-105 (2) (d), C.R.S. 1973)
104. Contracts for the lending of books and other resources to publicly-supported libraries and institutions. (Office of Library Services; 24-90-105 (1) (j), C.R.S. 1973)
105. Furnishes or contracts for the furnishing of library services to correctional, residential and medical institutions operated by the state. (Office of Library Services; 24-90-105 (1) (d), C.R.S. 1973)

106. Furnishes library services to the blind and physically handicapped. (Office of Library Services, Library for the Blind and Physically Handicapped; 24-90-105 (1) (e), C.R.S. 1973)
107. Collects, distributes and makes available to the public state publications through the State Publications Depository and Distribution Center. (Office of Library Services; 24-90-203 and 24-90-208, C.R.S. 1973)

Special Educational Program and Other Related Services

108. Supports and educates deaf and blind residents of the state. (Colorado School for the Deaf and the Blind; 22-80-101, C.R.S. 1973)
109. Identifies services to CETA clients provided by existing educational programs. (Office of Field Services, Community Based Education Services; no state statutory mandate)
110. Endeavors to see that nutritious meals and rewarding education opportunities are provided to eligible children at residential day camps, migrant schools and recreational programs during the summer. (Office of Field Services, Nutrition/Energy/Traffic; no state statutory mandate)
111. Operates a depository and retrieval network for visually and hearing handicapped children of textbooks, equipment and instructional and resource materials. (Office of Department Management Services, Special Education Services; 22-20-105, C.R.S. 1973)

Department Totals:

\$658,405 K-G
 \$2,132 K-C
 \$87,268 K-F
 \$161 K-HSA
 355.75 FTE

DEPARTMENT OF EDUCATION

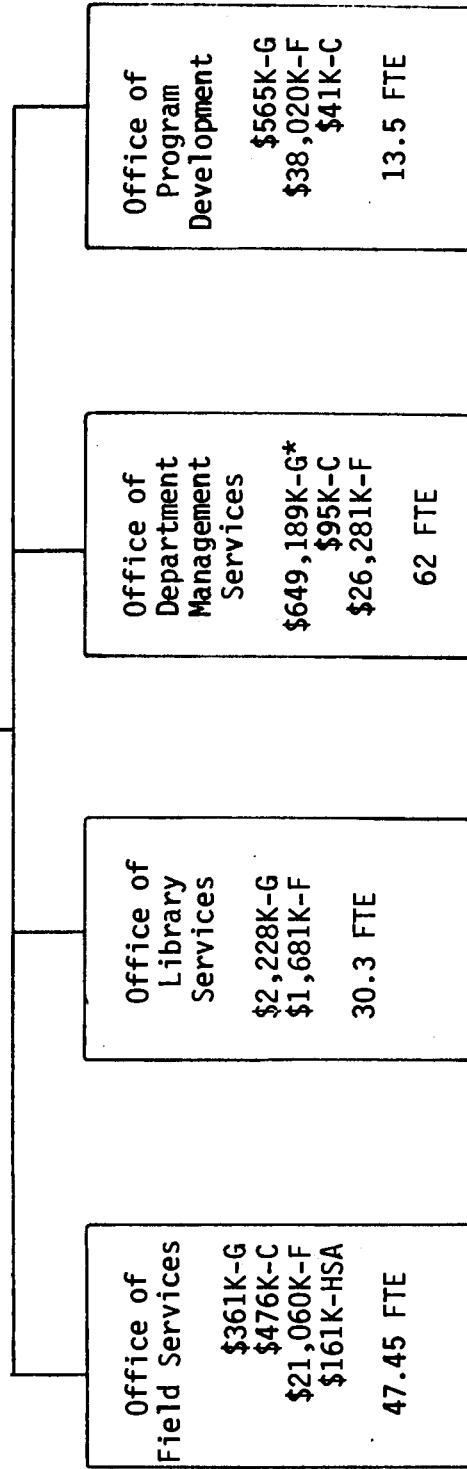
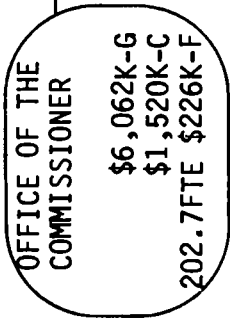
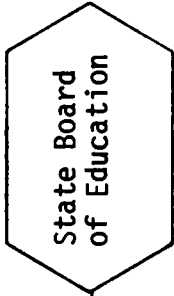

* \$608,968,000 of this money is distributed to local school districts.

\$6,062 K-G
\$1,519 K-C
\$226 K-F

206.7 FTE

OFFICE OF THE COMMISSIONER

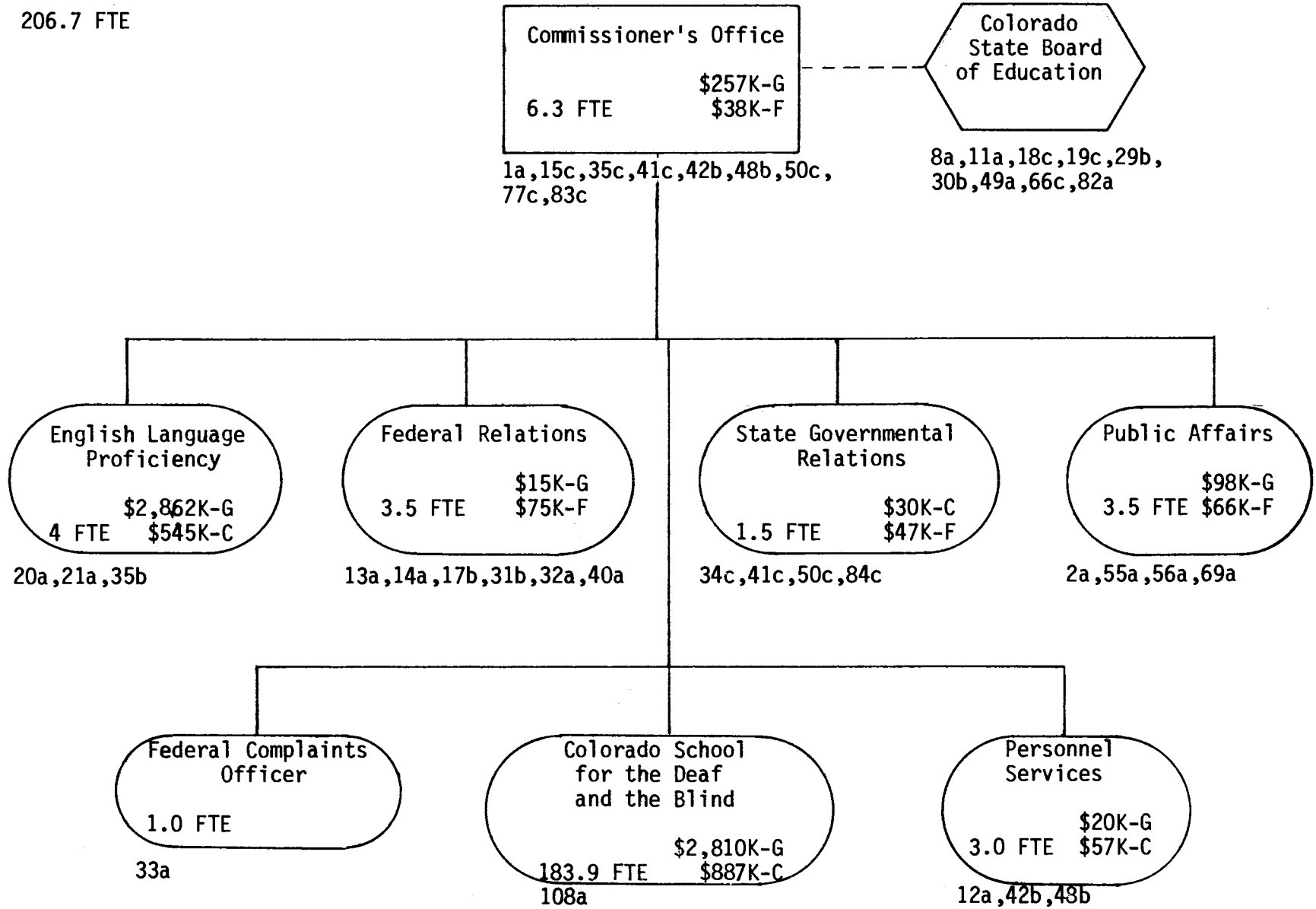

ED-14

\$649,189 K-G
\$195 K-C
\$ 26,281 K-F

72 FTE

OFFICE OF DEPARTMENT MANAGEMENT SERVICES

Director's Office
1.5 FTE \$51K-G
\$26K-F

7b,15c,34c,41c,44b,50c,
91b

School Finance
Distribution
\$608,968 K-G
4.0 FTE

16b,44b,66c,90a,
91b

Accounting and
Auditing
\$160K-G
\$177K-C
\$853K-F
13.5 FTE

37a,47a

Administrative
Support and
Technical Services
\$360K-G
\$61K-F
17 FTE

43a,53a,57a,58b,59a,
66c

Planning and
Evaluation
\$80K-G
\$18K-C
\$42K-F
8.0 FTE

15b,51b,54a,60a,61b,
67a,71a

Special Education
Services
\$39,570K-G
\$25,299K-F
28.0 FTE

7b,9a,16b,24a,45a,57c,
58b,62a,63a,66c,79a,
83c,111a

ED-15

Office Totals:

\$21,060 K-F
\$836 K-G
\$161 K-HSA*

47.45 FTE

OFFICE OF FIELD SERVICES

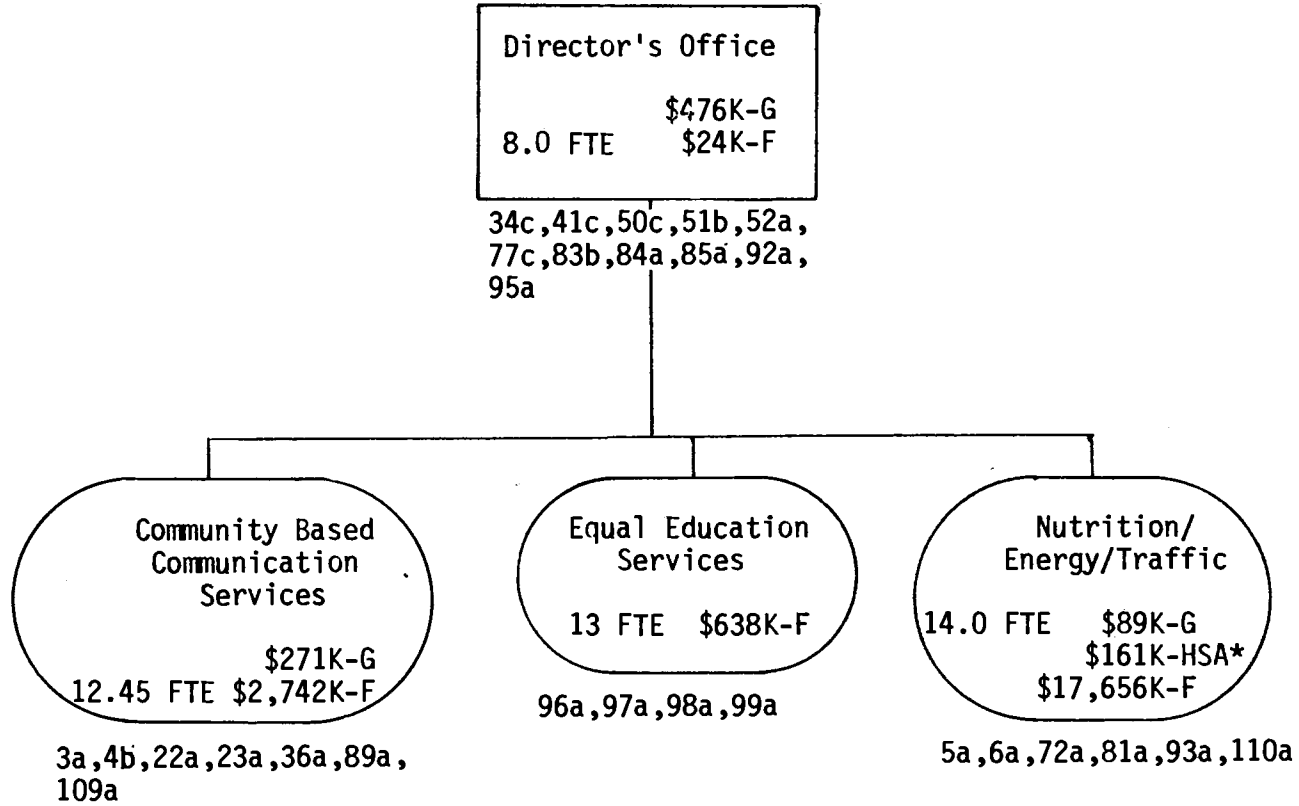

ED-16

\$2,228 K-G
\$1,681 K-F

31.80 FTE

OFFICE OF LIBRARY SERVICES

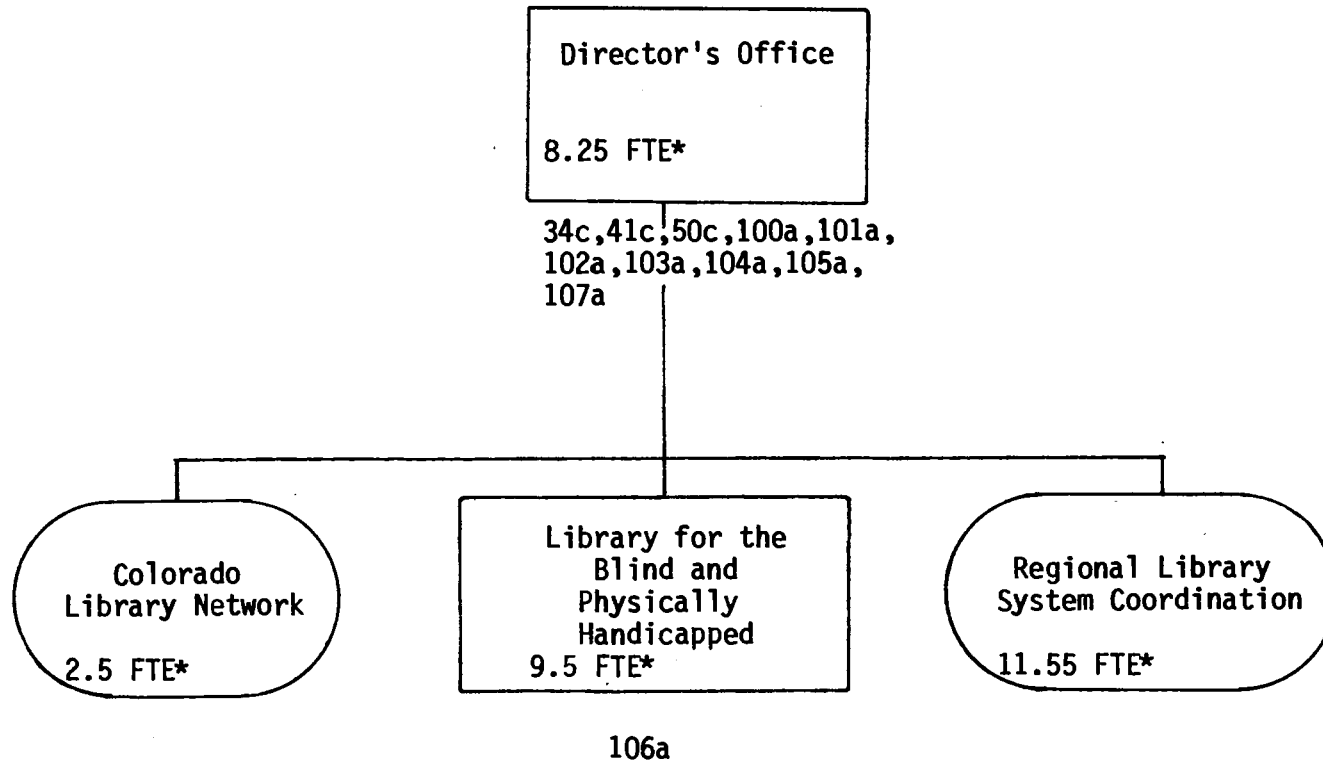

ED-17

* Funding sources not available.

Office Totals:

\$ 565 K-G
\$38,020 K-F
\$ 41 K-C

43.5 FTE

OFFICE OF PROGRAM DEVELOPMENT

ED-18

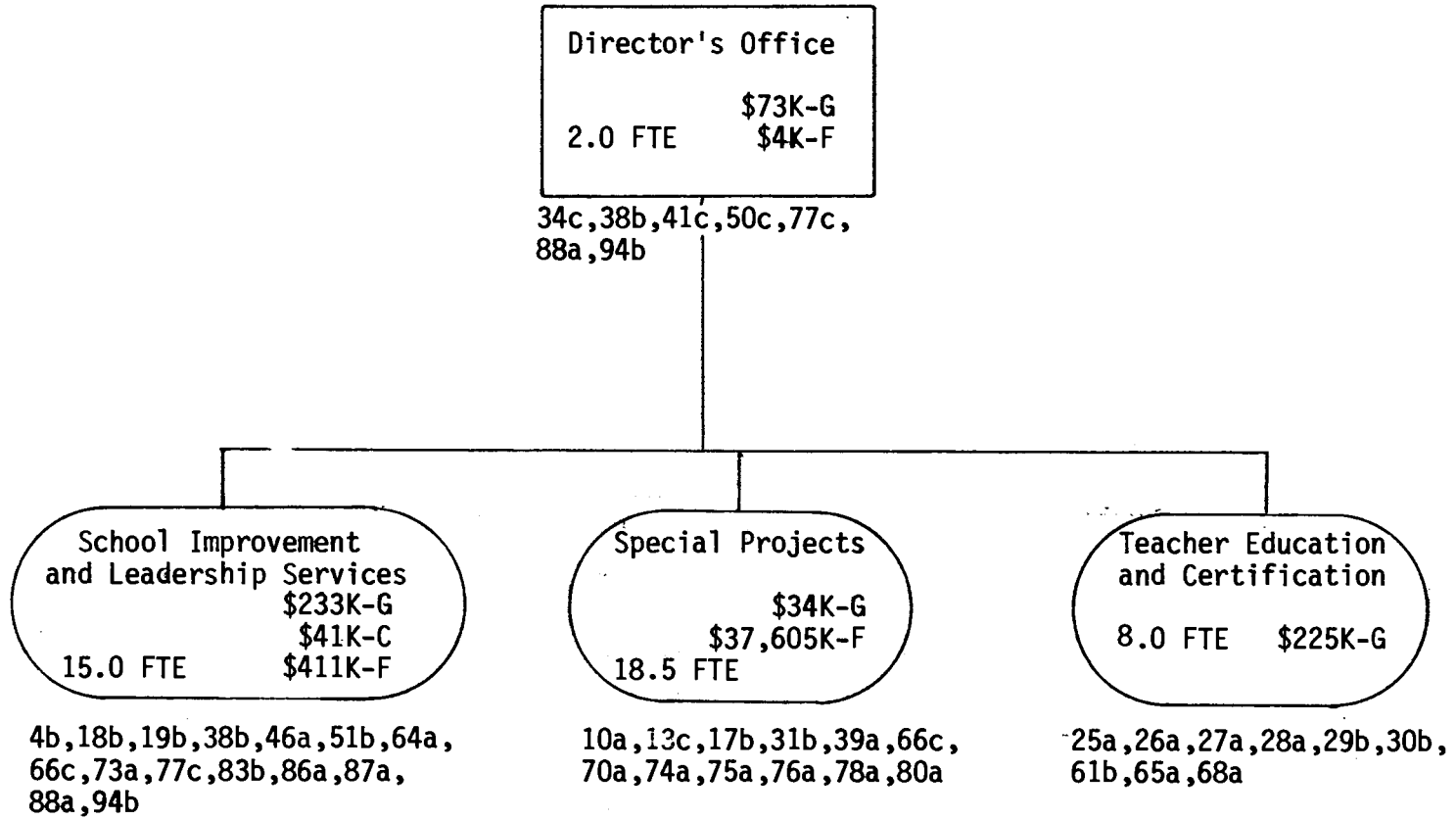

DEPARTMENT OF HEALTH

	<u>Page</u>
<u>Administers Consumer Protection Activities</u>	
Controlled Substances.....	HEA-1
Sanitation and Safety.....	HEA-1
Facilities and Products.....	HEA-1
Food.....	HEA-3

Administers Environmental Protection Activities

Air Quality Control.....	HEA-3
Administration.....	HEA-3
Regulation and Enforcement.....	HEA-4
Studies and Reports.....	HEA-4
Technical Advice.....	HEA-5
Disease Control.....	HEA-5
Animals.....	HEA-5
Investigation, Study and Regulation.....	HEA-6
Hazardous Waste Management.....	HEA-6
Disposal.....	HEA-6
Regulation.....	HEA-7
Technical Assistance.....	HEA-8
Noise Abatement.....	HEA-8
Radiation Control.....	HEA-8
Water Quality Control.....	HEA-8
Administration.....	HEA-8
Regulation and Enforcement.....	HEA-9
Studies and Reports.....	HEA-10

Coordinates Health Care Services

Alcohol and Drug Abuse.....	HEA-11
Community Nursing.....	HEA-12
Family Health Services.....	HEA-12
Infants.....	HEA-14

Develops, Regulates and Administers Medical Care

Emergency Medical Services.....	HEA-14
Health Facilities Regulation.....	HEA-14
Health Promotion.....	HEA-16
Statistics and Vital Records.....	HEA-16
Support Services for Health Programs.....	HEA-17
Administrative Services.....	HEA-17
Laboratory Services.....	HEA-17
Program Administration.....	HEA-18

DEPARTMENT OF HEALTH

Administers Consumer Protection Activities

Controlled Substances

1. Licenses manufacturers, wholesalers, researchers, and addiction programs dealing with controlled substances. (Office of Health Protection, Consumer Protection Division, Food, Drugs and Vector Control Section; 12-22-305, C.R.S. 1973)

Sanitation and Safety

Facilities and Products

2. Regulates the general sanitation conditions of places used for the preparation, storage, sale, or distribution of food. (Office of Health Protection, Consumer Protection Division, General Sanitation Section; 25-4-101 and 25-4-109, C.R.S. 1973)
3. Closes theatres, schools, and other public places, and forbids public gatherings to protect the public health. (Office of Health Protection, Consumer Protection Division, General Sanitation Section; 25-1-107 (1) (c), C.R.S. 1973)
4. Licenses persons engaged in the business of sterilizing bedding for the purpose of manufacturing, remaking, or renovating bedding. (Office of Health Protection, Consumer Protection Division, Food, Drugs and Vector Control Section; 25-5-305, C.R.S. 1973)
5. Administers the state's food and drug act which protects the public against the adulteration or misbranding of any food, drug, device, or cosmetic. (Office of Health Protection, Consumer Protection Division, Food, Drugs and Vector Control Section; 25-5-412, C.R.S. 1973)
6. Regulates hazardous household products. (Office of Health Protection, Consumer Protection Division, Food, Drugs and Vector Control Section; 25-5-506, C.R.S. 1973)
7. Enforces state laws against hazardous materials in eyeglass and sunglass frames and glass lenses. (Office of Health Protection, Consumer Protection Division, Food, Drugs and Vector Control Section; 25-5-603, C.R.S. 1973)
8. Receives and reviews plans for construction or enlargement of swimming areas. (Office of Health Protection, Water Quality Control Division, Drinking Water Section; 25-5-802,

C.R.S. 1973)

9. Inspects swimming areas. (Office of Health Protection, Consumer Protection Division, General Sanitation Section; 25-5-806, C.R.S. 1973)
10. Furnishes consulting services to local governments and private landowners regarding toilet facilities and procedures for the disposal of refuse at recreational areas and other public accommodation facilities. (Office of Health Protection, Consumer Protection Division, General Sanitation Section; 25-13-104, C.R.S. 1973)
11. Licenses and regulates sanitary conditions of food service establishments. (Office of Health Protection, Consumer Protection Division, General Sanitation Section; 12-44-203, C.R.S. 1973)
12. Provides public health sanitarians in areas not served by local or regional health departments. (Office of Health Protection, Consumer Protection Division, General Sanitation Section; 25-1-602, C.R.S. 1973)
13. Regulates grain and bean elevators. (Office of Health Protection, Consumer Protection Division, Food, Drugs and Vector Control Section; 25-5-401, et. seq., C.R.S. 1973)
14. Regulates water bottlers. (Office of Health Protection, Consumer Protection Division, Food, Drugs and Vector Control Section; 25-5-401, et seq., C.R.S. 1973)
15. Regulates hazardous insulating materials. (Office of Health Protection, Consumer Protection Division, Food, Drugs and Vector Control Section; 25-5-501, et seq., C.R.S. 1973)
16. Regulates general sanitation activities of, among others, hotels, motels, child care centers, schools, state institutions, jails, and mobile home parks. (Office of Health Protection, Consumer Protection Division, Food, Drugs and Vector Control Section; 25-1-107 (1) (m), C.R.S. 1973)
17. Establishes and enforces sanitary standards for the operation and maintenance of orphanages, day care nurseries, foster homes, family care homes, summer camps, lodging houses, hotels, public conveyances, schools, factories, workshops, recreational camps, swimming pools, mobile home parks, and other public places. (Office of Health Protection, Consumer Protection Division, General Sanitation Section; 25-1-107 (1) (m) and (n), C.R.S. 1973)

Food

18. Enforces standards on the enrichment of certain kinds of flour and bread. (Office of Health Protection, Consumer Protection Division, Food, Drugs and Vector Control Section; 25-5-205, C.R.S. 1973)
19. Impounds any vegetables and other edible crops, meats, and animal products intended but unfit for human consumption. (Office of Health Protection, Consumer Protection Division, General Sanitation and Food, Drugs and Vector Control Sections; 25-1-107 (1) (k), C.R.S. 1973)
20. Regulates fresh food production. (Office of Health Protection, Consumer Protection Division, Food, Drugs and Vector Control Section; 25-5-401, et seq., C.R.S. 1973)
21. Regulates carbonated beverage manufacturers. (Office of Health Protection, Consumer Protection Division, Food, Drugs and Vector Control Section; 25-5-401, et seq., C.R.S. 1973)
22. Regulates candy manufacturers. (Office of Health Protection, Consumer Protection Division, Food, Drugs and Vector Control Section; 25-5-401 et seq., C.R.S. 1973)
23. Regulates the production, processing and distribution of milk and milk products to ensure that they are safe and disease-free. (Office of Health Protection, Consumer Protection Division, Milk Sanitation Section; 25-1-107 (1) (o), C.R.S. 1973)

Administers Environmental Protection Activities

Air Quality Control

Administration

24. Prepares, revises and administers the state implementation plan for meeting federal air pollution standards. (Air Quality Control Commission; 25-7-105 and 25-7-301, C.R.S. 1973)
25. Establishes and reviews the classification of any attainment, nonattainment or unclassifiable area. (Air Quality Control Commission; 25-7-107, C.R.S. 1973)
26. Holds joint public hearings with the State Board of Health every October in order to hear public comments on air pollution problems and remedies. (Air Quality Control Commission; 25-7-105, C.R.S. 1973)

27. Certifies that facilities have been constructed, installed, or acquired in conformity with state or federal air quality requirements. (Office of Administration and Support, Administrative Services Division; 25-7-111, C.R.S. 1973)

Regulation and Enforcement

28. Promulgates emission control and permit regulations as well as ambient air quality standards. (Air Quality Control Commission; 25-7-105, 108, 109, and 114, C.R.S. 1973)
29. Processes permits for stationary emissions sources; inspects such sources to determine their compliance with permit conditions; and maintains a computerized inventory of these stationary sources. (Office of Health Protection, Air Pollution Control Division, Stationary Sources Section; 25-7-111, 114, and 206, C.R.S. 1973)
30. With regard to air quality, enforces compliance with statutory requirements, emission control regulations, and the state implementation plan. (Office of Administration and Support, Administrative Services Division; 25-7-111, 112, and 115, C.R.S. 1973)
31. Holds hearings and makes findings regarding permit problems, delayed compliance orders, and amendments to the state implementation plan. (Air Quality Hearings Board and Air Quality Control Commission; 25-7-119, C.R.S. 1973)
32. Operates a statewide monitoring network that collects data to evaluate air pollution control measure effectiveness; performs planning and analysis and maintains quality assurance. (Office of Health Protection, Air Pollution Control Division, Technical Services Section; 25-7-110, C.R.S. 1973)

Studies and Reports

33. Operates a statewide monitoring network that collects data to evaluate the effectiveness of air pollution control measures. (Office of Administration and Support, Administrative Services Division; 25-7-111, C.R.S. 1973)
34. Conducts studies on motor vehicle exhaust emissions and administers the Automobile Inspection and Readjustment (AIR) Program with the Colorado Department of Revenue. (Air Quality Control Commission, and Office of Health Protection, Air Pollution Control Division, Mobile Sources Section; 25-7-130 and 42-4-309, C.R.S. 1973)

35. Prepares a public report which provides a description of the pollution problem in each of the polluted areas of the state, identifies the stationary and mobile sources of air pollution for different areas of the state, and lists all the alleged violations of emission control regulations as well as the remedial actions taken in response to such violations. (Air Quality Control Commission; 25-7-105, C.R.S. 1973)
36. Reports annually to the Governor and General Assembly on the effectiveness of current state statutes regarding air pollution and recommends changes to such statutes. The report may include any recommendations with respect to emission standards and emission control devices. (Air Quality Control Commission; 25-7-105, C.R.S. 1973)
37. Conducts, or contracts out, studies regarding air pollution. (Office of Administration and Support, Administrative Services Division; 25-7-111, C.R.S. 1973)

Technical Advice

38. Furnishes technical advice and services relating to air pollution problems and control techniques, and performs planning and analysis. (Office of Administration and Support, Administrative Services Division; 25-7-111, C.R.S. 1973)

Disease Control

Animals

39. Licenses pet shops and boarding kennels. (Office of Health Protection, Disease Control and Epidemiology Division, Communicable Disease Control Section; 12-57-104, C.R.S. 1973)
40. Establishes minimum standards for pet shops and kennels. (Office of Health Protection, Disease Control and Epidemiology Division, Communicable Disease Control Section; 12-57-107, C.R.S. 1973)
41. Licenses psittacine bird dealers. (Office of Health Protection, Disease Control and Epidemiology Division, Communicable Disease Control Section; 25-4-706, C.R.S. 1973)
42. Conducts a program of prevention against psittacosis in psittacine birds to prevent its spread to other birds or handlers. (Office of Health Protection, Disease Control and Epidemiology Division, Communicable Disease Control Section; 25-4-710, C.R.S. 1973)

Investigation, Study, and Regulation

43. Regulates the control of disease-spreading insects. (Office of Health Protection, Consumer Protection Division, Food, Drugs and Vector Control Section; 25-1-101, et seq., C.R.S. 1973)
44. Investigates and controls the causes of epidemic and communicable diseases affecting the public health. (Office of Health Protection, Disease Control and Epidemiology Division, Communicable Disease Control Section; 25-1-107 (1) (a), C.R.S. 1973)
45. Investigates sources of venereal diseases and prepares, for free distribution, printed information concerning the dangers from venereal diseases. (Office of Health Protection, Disease Control and Epidemiology Division, Communicable Disease Control Section; 25-4-404 and 25-5-102, C.R.S. 1973)
46. Maintains a cancer registry. (Office of Health Protection, Disease Control and Epidemiology Division, Chronic Disease Control Section; 25-1-107, C.R.S. 1973)
47. Investigates and attempts to control disease and death from chronic conditions such as cancer, diabetes and hypertension. (Office of Health Protection, Disease Control and Epidemiology Division, Chronic Disease Control Section; 25-1-107, C.R.S. 1973)
48. Uses epidemiologic tools and techniques to study environmental problems which result in human illness. (Office of Health Protection, Disease Control and Epidemiology Division, Environmental Disease Control Section; 25-1-107, C.R.S. 1973)
49. Approves a standard serological test as the test for syphilis. (Office of Health Protection, Disease Control and Epidemiology Division, Communicable Disease Control Section; 25-4-202, C.R.S. 1973)
50. Conducts testing for metabolic defects pursuant to standards established by the State Board of Health. (Laboratory Division, Microbiology Section; 25-4-802 (1) and (2), C.R.S. 1973)

Hazardous Waste Management

Disposal

51. Receives and disposes of hazardous wastes which cannot reasonably be handled by commercial agencies. (Office of

Health Protection, Waste Management Division, Hazardous Waste Management Section; 25-15-104, C.R.S. 1973)

Regulation

52. Establishes criteria for the engineering design and operation of hazardous waste disposal sites and advises boards of county commissioners in their consideration of applications for local disposal sites. (Office of Health Protection, Waste Management Division, Hazardous Waste Management Section and Facility Review and Monitoring Section; 25-15-202 and 25-15-208, C.R.S. 1973))
53. Regulates hazardous waste management under the memorandum of agreement executed with the federal government. (Office of Health Protection, Waste Management Division, Hazardous Waste Management Section; 25-15-301, C.R.S. 1973))
54. Enters into agreements with local governments to monitor, inspect, and provide technical services in executing the state's responsibility to regulate hazardous waste management. (Office of Health Protection, Waste Management Division, Hazardous Waste Management Section; 25-15-301, C.R.S. 1973))
55. Participates in the implementation of the federal "Comprehensive Environmental Response, Compensation, and Liability Act of 1980" regarding the management of hazardous waste. (Office of Health Protection, Waste Management Division, Hazardous Waste Management Section; 25-16-103, C.R.S. 1973))
56. Issues permits for the treatment, storage, and disposal of hazardous wastes and enforces the provisions of such permits. (Office of Health Protection, Waste Management Division, Hazardous Waste Management Section; 25-15-301 (2) (a), C.R.S. 1973))
57. Formulates rules and regulations for the storage, treatment, and disposal of hazardous wastes and the operation of such facilities and forwards the same to the State Board of Health for promulgation. (Office of Health Protection, Waste Management Division, Hazardous Waste Management Section; 25-15-302 (2), C.R.S. 1973))

Technical Assistance

58. Provides technical assistance to hazardous waste generators and storers, and to the operators of disposal sites. (Office of Health Protection, Waste Management Division, Hazardous Waste Management Section; 25-15-103, C.R.S. 1973)
59. Assists, upon request, in formulating a response to hazardous materials incidents. (Office of Health Protection, Waste Management Division, Hazardous Waste Management Section; 29-22-103, C.R.S. 1973)

Noise Abatement

60. Establishes statewide standards for noise level limits. (Office of Health Protection, Radiation Control Division, Denver Radiation Section; 25-12-101, C.R.S. 1973)

Radiation Control

61. Issues licenses pertaining to radioactive materials and develops programs for evaluation and control of hazards associated with the use of radioactive materials. (Office of Health Protection, Radiation Control Division, Denver Radiation Control Section; 25-11-103, C.R.S. 1973)
62. Furnishes technical advice to the Department of Health on matters relating to radiation control. (Radiation Advisory Committee; 25-11-105, C.R.S. 1973)
63. Approves all facilities used for the disposal of radioactive waste. (Office of Health Protection, Radiation Control Division, Denver Radiation Control Section; 25-11-203, C.R.S. 1973)
64. Participates with the federal government in the federal uranium mill tailings radiation control act. (Office of Health Protection, Radiation Control Division, Grand Junction Radiation Control Section; 25-11-303, C.R.S. 1973)

Water Quality Control

Administration

65. Develops or reviews regional wastewater management plans and amendments to such plans. (Office of Administration and Support, Administrative Services Division; 25-8-105, C.R.S. 1973)
66. Adopts priority rankings for the administration of federal

the commission or the Division of Administration administers. (Water Quality Control Commission; 25-8-202, C.R.S. 1973)

67. Administers and enforces the water quality control programs adopted by the state Water Quality Control Commission. (Office of Administration and Support, Administrative Services Division; 25-8-301, C.R.S. 1973)
68. Administers permits for the discharge of pollutants into the state's lakes and streams. (Office of Health Protection, Water Quality Control Division, Permits Section; 25-8-501, C.R.S. 1973)
69. Provides technical assistance regarding water and wastewater treatment to plant operators and local health departments. (Office of Health Protection, Water Quality Control Division, Field Services Section; 25-8-301 et seq., C.R.S. 1973)

Regulation and Enforcement

70. Develops and maintains a comprehensive program for prevention, control and abatement of water pollution and for water quality protection throughout the state. (Water Quality Control Commission; 25-8-202, C.R.S. 1973)
71. Promulgates water quality standards which describe water characteristics or the extent of specifically identified pollutants for state waters. (Water Quality Control Commission; 25-8-202, C.R.S. 1973)
72. Promulgates control regulations for identified pollutants, discharge of wastes into state waters, and toxic effluent. (Water Quality Control Commission; 25-8-202, C.R.S. 1973)
73. Reviews and certifies or denies requests for certifications in compliance with section 401 of the federal water quality control act. (Office of Administration and Support, Administrative Services Division; 25-8-301, C.R.S. 1973)
74. Enters and inspects premises and records for the purpose of investigating actual or suspected sources of water pollution using, insofar as practicable, qualified personnel of the Department of Agriculture as authorized representatives. (Water Quality Control Division, Enforcement Section; 25-8-306, C.R.S. 1973)
75. Enforces minimum sanitary standards and regulations for drinking water supplied to the public. (Office of Health Protection, Water Quality Control Division, Drinking Water Section; 25-1-109 (1) (h), C.R.S. 1973)

76. As conditions in permits for the discharge of pollutants from publicly owned wastewater treatment works, insures compliance by industrial users with a system of user charges or industrial cost recovery. (Office of Health Protection, Water Quality Control Division, Permits Section; 25-8-505, C.R.S. 1973)
77. With regard to domestic wastewater treatment works, approves site locations and designs for construction or expansion, and enters into contracts with small communities for project grants. (Office of Health Protection, Water Quality Control Division, Municipal Facilities Section; 25-8-702 and 25-8-703, C.R.S. 1973)
78. Establishes regulations and minimum standards for individual sewage disposal systems and consults with local health departments regarding the local enforcement of regulations and standards. (Office of Health Protection, Water Quality Control Division, Field Services Section; 25-10-104 and 25-10-105, C.R.S. 1973)
79. Samples the discharged wastewater from municipalities, industries and others as it is dumped into public streams to determine whether it is meeting standards outlined in permits; acts on complaints of unauthorized discharges; and, if necessary, issues cease and desist and clean-up orders. (Office of Health Protection, Water Quality Control Division, Enforcement Section; 25-8-606 and 25-8-404 - 406, C.R.S. 1973)

Studies and Reports

80. Holds public hearings during the month of October of each year in order to hear public comment on water pollution problems within the state, alleged sources of water pollution, and the availability of practical remedies therefor, and reports to the Governor and the General Assembly on or before November 1 of each year on the effectiveness of the law. (Water Quality Control Commission; 25-8-202, C.R.S. 1973)
81. Classifies state waters describing relevant characteristics, such as the maximum extent of pollution to be tolerated, and the use, type and character of the water and reviews, at intervals of not more than three years, each classification of waters, water quality standards, and control regulations. (Water Quality Control Commission; 25-8-202, C.R.S. 1973)
82. Determines the quality of every reasonably accessible segment of state waters. (Office of Health Protection, Water Quality Control Division, General Services Section; 25-8-303, C.R.S. 1973)

83. Determines the nature and amount of each pollutant in state waters and determines whether a new or different water quality standard is needed for the pollutant. (Office of Health Protection, Water Quality Control Division, General Services Section; 25-8-303, C.R.S. 1973)
84. Conducts studies with respect to water pollution; furnishes technical advice; designates quality control authorities; advises, consults, and enters into agreements with other agencies of the state and federal government and other groups affected by the state's water quality law; and certifies the existence of facilities as having been acquired, constructed, or installed in conformity with the purposes of the state's water quality law. (Office of Health Protection, Water Quality Control Division, General Services Section; 25-8-308, C.R.S. 1973)

Coordinates Health Care Services

Alcohol and Drug Abuse

85. Provides fiscal management and planning assistance for alcohol and drug abuse programs. (Office of Health Care Services, Alcohol and Drug Abuse Division, Administrative Support, Planning and Evaluation Section; 25-1-303 and 304, C.R.S. 1973)
86. Reviews those alcohol and drug abuse programs that seek state or federal funding, and distributes grants for such programs from funds appropriated by the General Assembly or from any other governmental or private source. (Office of Health Care Services, Alcohol and Drug Abuse Division, Administrative Support, Planning and Evaluation Section; 25-1-203, 209, and 305, C.R.S. 1973)
87. Supervises the administration of the state plan for alcohol and drug abuse programs. (Office of Health Care Services, Alcohol and Drug Abuse Division, Administrative Support, Planning and Evaluation Section; 25-1-202 and 303, C.R.S. 1973)
88. Cooperates with the Department of Education, schools, police departments, courts, and other public and private agencies in establishing programs for the prevention and treatment of alcoholism and in preparing school curriculum on this subject; sponsors research on alcoholism; and operates a training program to certify counselors. (Office of Health Care Services, Alcohol and Drug Abuse Division, Prevention, Intervention, and Treatment Section; 25-1-304, C.R.S. 1973)
89. Operates treatment centers for alcoholics. (Office of Health Care Services, Alcohol and Drug Abuse Division,

Prevention, Intervention, and Treatment Section; 25-1-305, C.R.S. 1973)

90. Licenses and monitors drug and alcohol treatment facilities. (Office of Health Care Services, Alcohol and Drug Abuse Division, Prevention, Intervention, and Treatment Section; 25-1-306, C.R.S. 1973))

Community Nursing

91. Directly supervises county health nurses. (Office of Health Care Services, Community Nursing Section; 25-1-101 et seq., C.R.S. 1973))
92. Provides public health nurses in areas not served by local or regional health departments. (Office of Health Care Services, Community Nursing Section; 25-1-602, C.R.S. 1973))

Family Health Services

93. Conducts an active program of hospitalization and treatment of tubercular patients. (Office of Health Protection, Disease Control and Epidemiology Division, Communicable Disease Control Section; 25-4-511, C.R.S. 1973))
94. Receives and disburses funds for family planning programs to organizations engaged in providing contraceptive procedures, supplies, and information. (Office of Health Care Services, Family Health Services Division, Women's and Children's Health Services Section; 25-6-103, C.R.S. 1973))
95. Monitors the state's family medicine residency programs. (Advisory Commission on Family Medicine; 25-1-902, C.R.S. 1973))
96. Administers a program of dental assistance to provide dentures, maintenance and related dental services for persons receiving old age pension public assistance. (Office of Health Care Services, Family Health Services Division, Dental Health Section; 25-21-104, C.R.S. 1973))
97. Screens and provides referral services for maternal and infant care programs and community maternity, family planning, and children and youth programs. (Office of Health Care Services, Family Health Services Division, Women's and Children's Health Services Section; 25-1-101, et seq., C.R.S. 1973))
98. Administers the homebound dentistry program. (Office of Health Care Services, Family Health Services Division, Dental Health Section; 25-1-101, et seq., C.R.S. 1973))

99. Provides supplemental foods for low income, nutritionally at-risk pregnant women, infants and children. (Office of Health Care Services, Family Health Services Division, Nutrition/WIC Section; 25-1-101, et seq., C.R.S. 1973)
100. Makes provisions for health, dental and nutrition services to migrant and seasonal farmworkers and their families. (Office of Health Care Services, Family Health Services Division, Migrant Health Section; 25-1-101, et seq., C.R.S. 1973)
101. Provides refugee health consultation services. (Office of Health Care Services, Family Health Services Division, Women's and Children's Health Services Section; 25-1-101, et seq., C.R.S. 1973; Public Laws 81-692 and 87-692)
102. Provides diagnostic and treatment services for physically handicapped children between birth and 21 years of age whose families cannot afford the cost of care. (Office of Health Care Services, Family Health Services Division, Handicapped Children Section; 25-1-101, et seq., C.R.S. 1973)
103. Provides consultation and professional casework and referral services for the following programs: handicapped children, early periodic screening, diagnosis and treatment, and dental and family planning programs. (Office of Health Care Services, Family Health Services Division, Social Work Section; 25-1-101, et seq., C.R.S. 1973)
104. Identifies and screens low income children with dental-facial handicaps for orthodontic care, administers the Old Age Pensioners Dental Program, and provides consultation for community water fluoridation programs. (Office of Health Care Services, Family Health Services Division, Dental Health Section; 25-21-101, C.R.S. 1973)
105. Provides medical consultation services for early genetic screening, diagnosis and treatment, refugee health, and developmental evaluation programs. (Office of Health Care Services, Medical Affairs and Special Programs Section; 25-4-801, et. seq., and 25-4-1004 - 1006, C.R.S. 1973)

Infants

106. Provides for the distribution of a prophylaxis to be used in treating the eyes of newly born infants. (Office of Health Protection, Disease Control and Epidemiology Division, Communicable Disease Control Section; 25-4-302, C.R.S. 1973)
107. Establishes rules and regulations for the administration of the state's school entry immunization program. (Office of Health Protection, Disease Control and Epidemiology Division, Communicable Disease Control Section; 25-4-904, C.R.S. 1973)

Develops, Regulates and Administers Medical Care

Emergency Medical Services

108. Assists, when requested by local governmental entities, in planning and implementing emergency medical services for the state. (Office of Medical Care Regulation and Development, Emergency Medical Services Division; 25-3.5-102, C.R.S. 1973)
109. Maintains the Rocky Mountain Poison Center WATS line. (Office of Medical Care Regulation and Development, Emergency Medical Services Division; 25-1-101, et seq., C.R.S. 1973)
110. Advises the Department of Health on all matters relating to emergency medical services programs. (Office of Medical Care Regulation and Development, Emergency Medical Services Division; 25-3.5-104, C.R.S. 1973)
111. Designs and establishes specialized curricula for personnel who respond to health emergencies and issues certificates for those completing the course. (Office of Medical Care Regulation and Development, Emergency Medical Services Division; 25-3.5-201, C.R.S. 1973)

Health Facilities Regulation

112. Receives and acts upon applications for the establishment of regional health departments. (Office of Administration and Support, Local Health Services; 25-1-702, C.R.S. 1973)
113. Licenses and certifies on an annual basis all health facilities in the state both under the state statutes and federal Medicare-Medicaid certification standards where applicable (these facilities include general hospitals, psychiatric hospitals, community clinics, rehabilitation centers, convalescent centers, community mental health

centers, facilities for the mentally retarded, habilitation centers for brain-damaged children, chiropractic centers and hospitals, maternity hospitals, nursing care facilities, intermediate care facilities, residential care facilities, pilot project rehabilitative nursing facilities, or other institutions of a like nature). (Office of Medical Care Regulation and Development, Health Facilities Regulation Division, Health Facilities Administration Section; 25-3-101 and 102, C.R.S. 1973)

114. Licenses maternity hospitals and directs and enforces regulations concerning maternity hospitals. (Office of Medical Care Regulation and Development, Health Facilities Regulation Division, Health Facilities Administration Section; 25-3-202, C.R.S. 1973)
115. Serves as the state agency for implementing the federal "Hospital Survey and Construction Act" including the formulation and administration of a state plan which provides for adequate hospital facilities for all Colorado residents. (Office of Medical Care Regulation and Development, Health Facilities Regulation Division, Health Facilities Administration Section; 25-3-401, C.R.S. 1973)
116. Provides minimum standards for the maintenance and operation of hospitals receiving federal aid. (Office of Medical Care Regulation and Development, Health Facilities Regulation Division, Health Facilities Administration Section; 25-3-401 (2), C.R.S. 1973)
117. Suspends or revokes the license of the operator of any health facility to safeguard the rights of patients. (Office of Medical Care Regulation and Development, Health Facilities Regulation Division, Health Facilities Administration Section; 25-3-103, C.R.S. 1973)
118. Handles grievances regarding licensed health facilities. (Office of Medical Care Regulation and Development, Health Facilities Regulation Division, Quality Assurance Section; 25-1-120 (5), C.R.S. 1973)
119. Develops general principles to govern health system agencies and the health facilities review council as it evaluates applications for certificates of public necessity. (Office of Medical Care Regulation and Development, Health Facilities Regulation Division, Certificate of Need Section; 25-3-514, C.R.S. 1973)
120. Evaluates and acts on applications for certificates of public necessity. (Office of Medical Care Regulation and Development, Health Facilities Regulation Division, Certificate of Need Section; 25-3-508, C.R.S. 1973)

121. At the request of the health facilities review council, analyzes applications for proposed new construction or changes to health care facilities in the state, and presents recommendations to the council for consideration of whether or not to issue certificates of public necessity for proposed projects. (Office of Medical Care Regulation and Development, Health Facilities Regulation Division, Certificate of Need Section; 25-3-508, C.R.S. 1973)
122. Reviews the quality of care given to Medicaid patients and is involved in the physical assessment of long-term care patients. Reviews medical records to determine the adequacy and appropriateness of nursing and other services received by patients. (Office of Medical Care Regulation and Development, Health Facilities Regulation Division, Quality Assurance Section; 25-3-101, et seq., C.R.S. 1973)

Health Promotion

123. Works to improve the health care system through the implementation of its policy, planning and evaluation studies. (Office of Medical Care Regulation and Development, Health Policy, Planning and Evaluation Division; P.L. 93-641, 25-1-101, et seq., C.R.S. 1973)
124. Disseminates health information to the public. (Office of Health Care Services, Health Promotion and Education Section; 25-1-107 (1) (q), C.R.S. 1973)
125. Assists local communities in developing effective health education programs. (Office of Health Care Services, Health Promotion and Education Services; 25-1-501, et seq., C.R.S. 1973)

Statistics and Vital Records

126. Performs the initial recording of births, adoptions, deaths, fetal deaths, and marriage dissolutions and transmits the original copy of such records to the State Registrar. (Office of Medical Care Regulation and Development, Health Statistics and Vital Records Division, Vital Statistics Section; 14-10-120, 19-6-124, and 25-2-107, C.R.S. 1973)
127. Compiles health-related statistical data for the state. (Office of Medical Care Regulation and Development, Health Statistics and Vital Records Division, Health Statistics Section; 25-2-105, C.R.S. 1973)

Support Services for Health Programs

Administrative Services

128. Provides support services for all departmental programs including budgeting, accounting, personnel, purchasing, public relations, building and grounds maintenance, printing and reproduction, mail service, and data processing. (Office of Administration and Support, Administrative Services Division; 25-1-109, C.R.S. 1973)
129. Provides technical and clerical staff to the Colorado Health Facilities Review Council. (Office of Medical Care Regulation and Development, Health Facilities Regulation Division, Certificate of Need Section; 25-3-504, C.R.S. 1973)
130. Hears appeals from decisions of the Health Facilities Review Council concerning the denial of an application for a certificate of public necessity. (State Board of Health; 25-3-512 and 25-1-107 (1) (q), C.R.S. 1973)
131. Receives reports from individuals who perform electroconvulsive treatment. (Office of Medical Care Regulation and Development, Health Statistics and Vital Records Division, Health Statistics Section; 25-2-120, C.R.S. 1973)
132. Provides financial support and technical expertise to local health units which act as the primary providers of direct public health services. (Office of Administration and Support, Local Health Services; 25-1-516, C.R.S. 1973)

Laboratory Services

133. Establishes, maintains, and approves chemical, bacteriological, and biological laboratories and conducts laboratory investigations and experimentations necessary to protect the public health. (Office of Administration and Support, Laboratory Division; 25-1-107 (1) (h), 25-4-1004 through 25-4-1006, and 42-4-1202 (3) (b), C.R.S. 1973)
134. Chemically analyzes milk, food, drugs, pesticides, drinking water, air pollution, radiation and hazardous wastes. (Office of Administration and Support, Laboratory Division, Chemistry Section; 25-1-107 (1) (h), C.R.S. 1973)
135. Makes a chemical analysis of food and drug samples. (Office of Administration and Support, Laboratory Division, Chemistry Section; 25-1-403, C.R.S. 1973)
136. Conducts tests for phenylketonuria and other metabolic

defects in newborn infants. (Office of Administration and Support, Laboratory Division, Microbiology Section; 25-4-802, C.R.S. 1973)

137. Conducts the following programs in laboratory microbiology: milk testing, water bacteriology testing, medical microbiology, and genetic testing. (Office of Administration and Support, Laboratory Division, Microbiology Section; 25-1-107 (1) (h) and 25-4-1004 to 25-4-1006, C.R.S. 1973)
138. Conducts tests on blood samples from the bodies of all pilots, drivers or pedestrians who die within four hours after involvement in a crash. (Office of Administration and Support, Laboratory Division, Microbiology Section; 42-4-1211, C.R.S. 1973)
139. Establishes and administers state programs of newborn screening, genetic counseling and education, and assesses a laboratory fee for such testing. (Office of Administration and Support, Laboratory Division, Microbiology Section; 25-4-1004, C.R.S. 1973)

Program Administration

140. Administers and enforces the public health laws of the state and the standards, orders, rules and regulations issued by the State Board of Health. (Office of Administration and Support, Administrative Services Division; 25-1-109, C.R.S. 1973)
141. Prepares and transmits a report annually to the Governor and the General Assembly which describes how the Health Department and its subdivisions efficiently discharged their responsibilities. (Office of Administration and Support, Administrative Services Division; 25-1-109, C.R.S. 1973)
142. Adopts rules, regulations, and standards concerning building regulations and fire safety for skilled and intermediate health care facilities. (State Board of Health; 25-1-108, C.R.S. 1973)

Department Totals:

\$46,594 K-G
 \$31,419 K-F
 \$6,741 K-C

833.6 FTE

DEPARTMENT OF HEALTH

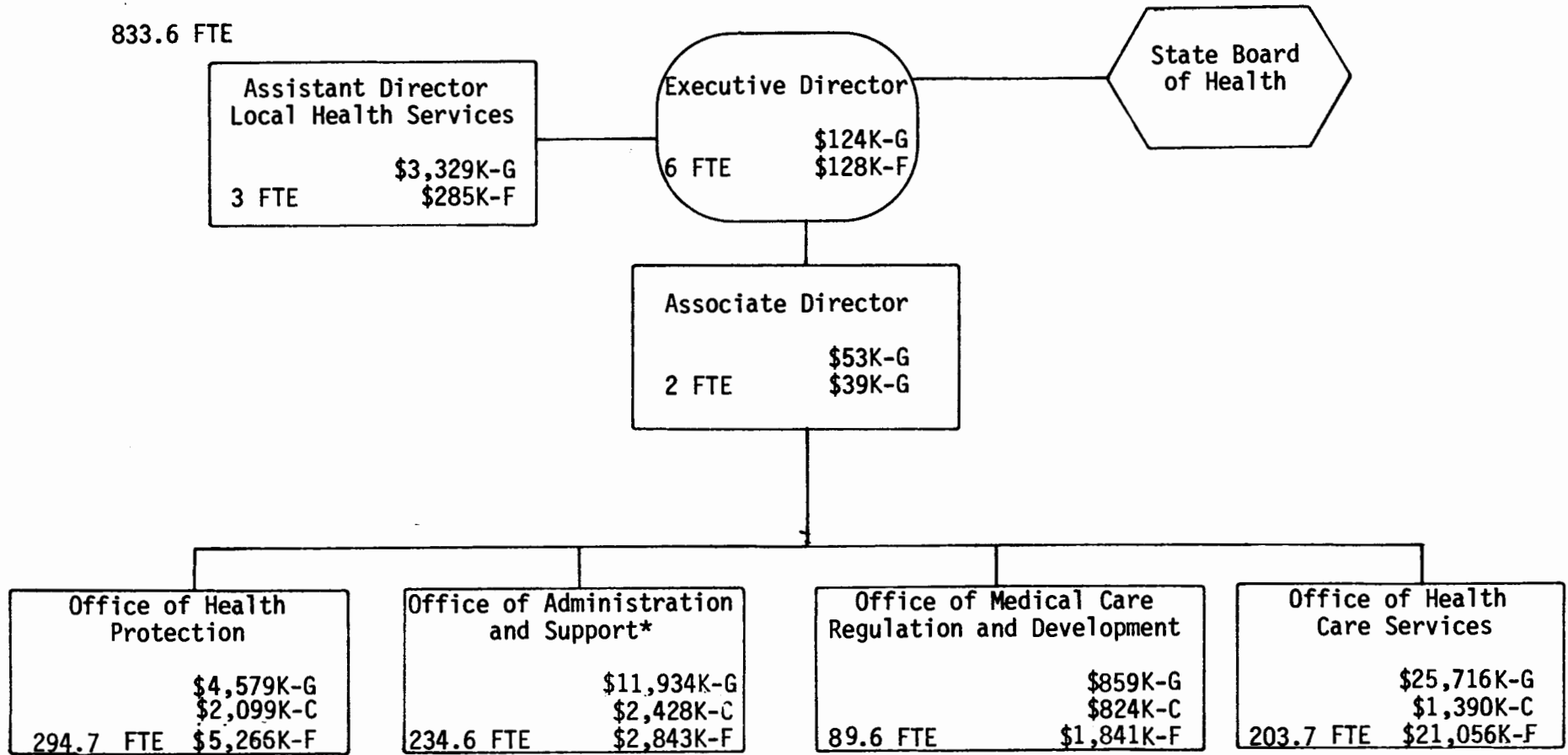

HEA-19

* Totals include Executive Director, Associate Director and Assistant Director

Office Totals:

\$11,934 K-G
\$2,428 K-C
\$2,862 K-F

234.6 FTE

OFFICE OF ADMINISTRATION AND SUPPORT

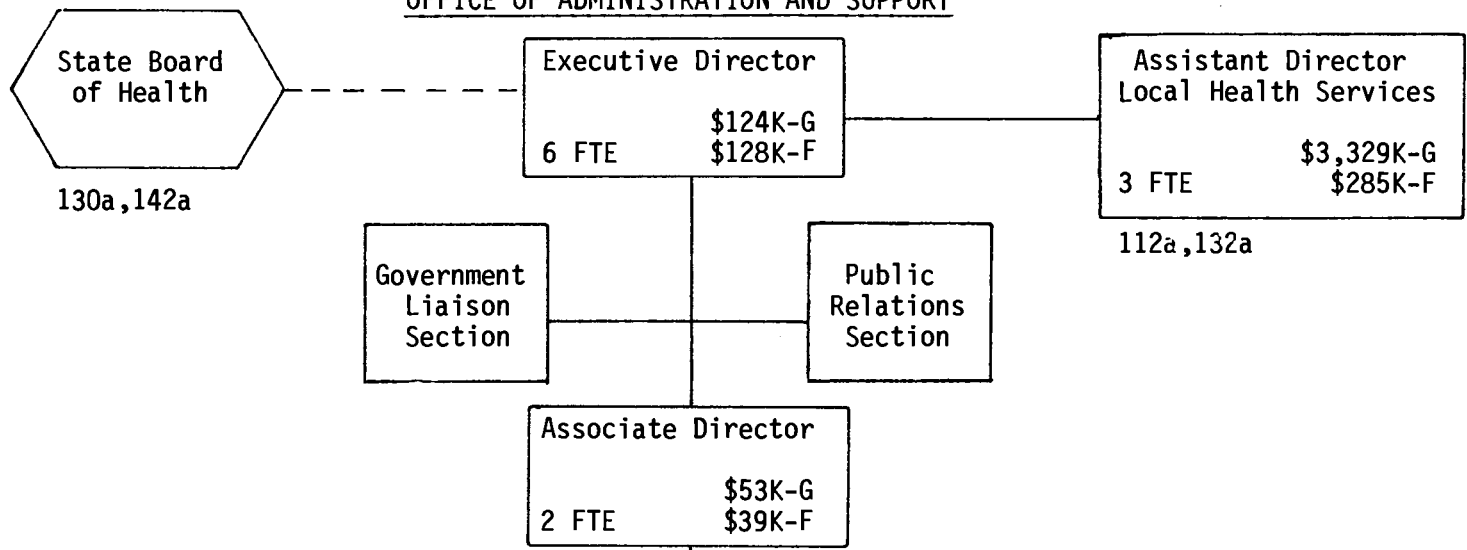

HEA-20

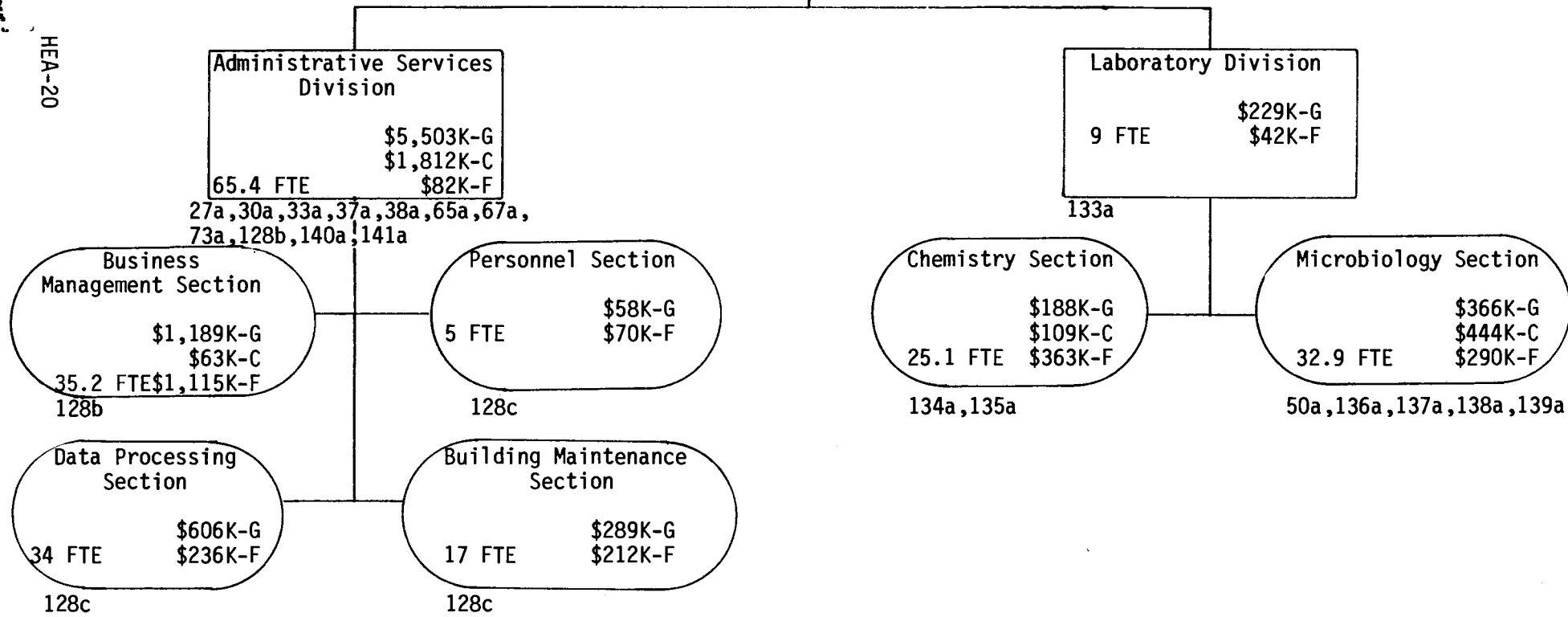

OFFICE OF HEALTH CARE SERVICES

Office Totals:

\$25,716 K-G
 \$1,390 K-C
 \$21,526 K-F

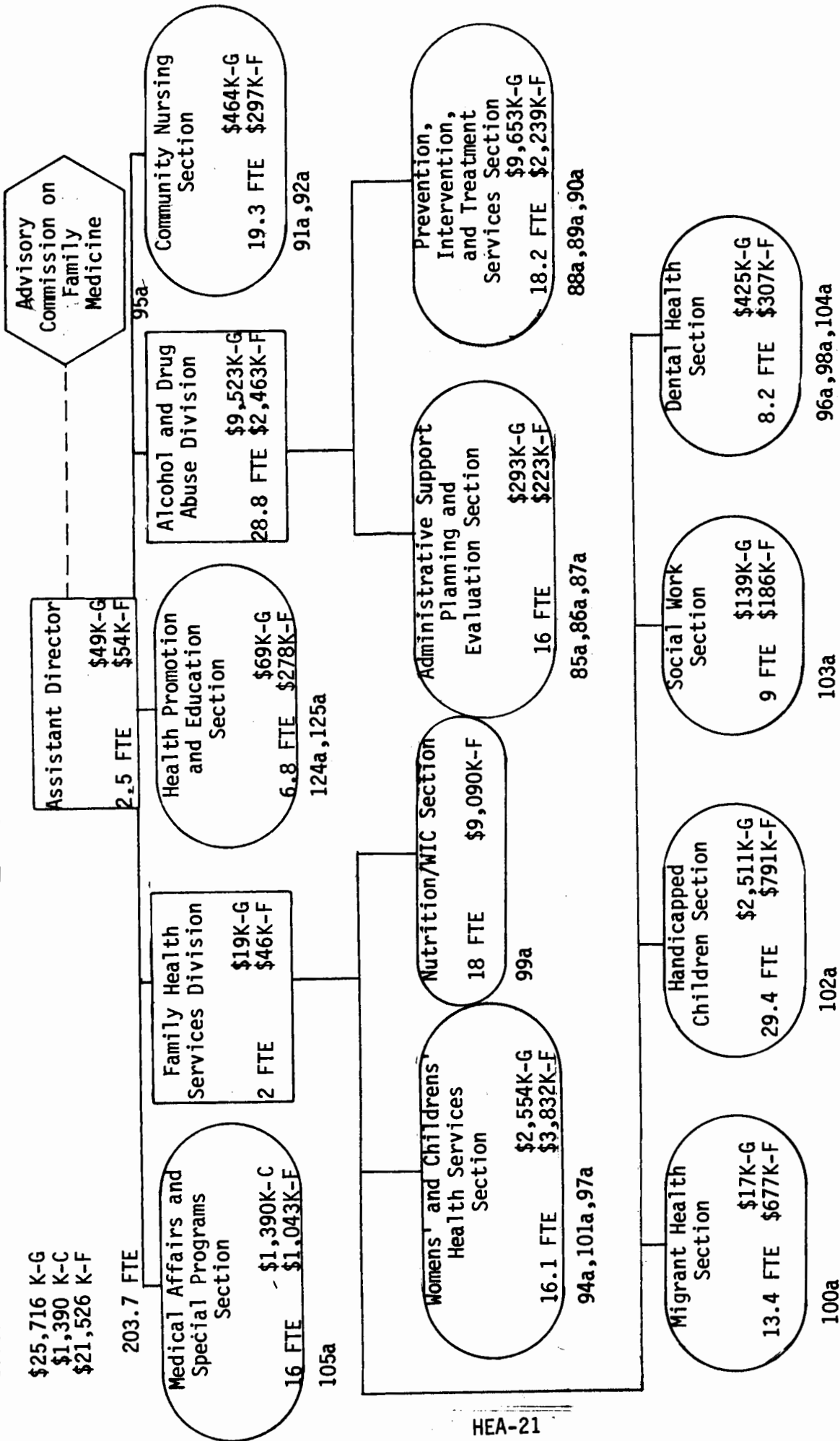

TOTALS: \$4,579 K-G
 \$2,099 K-C
 \$5,266 K-F

OFFICE OF HEALTH PROTECTION

294.7 FTE

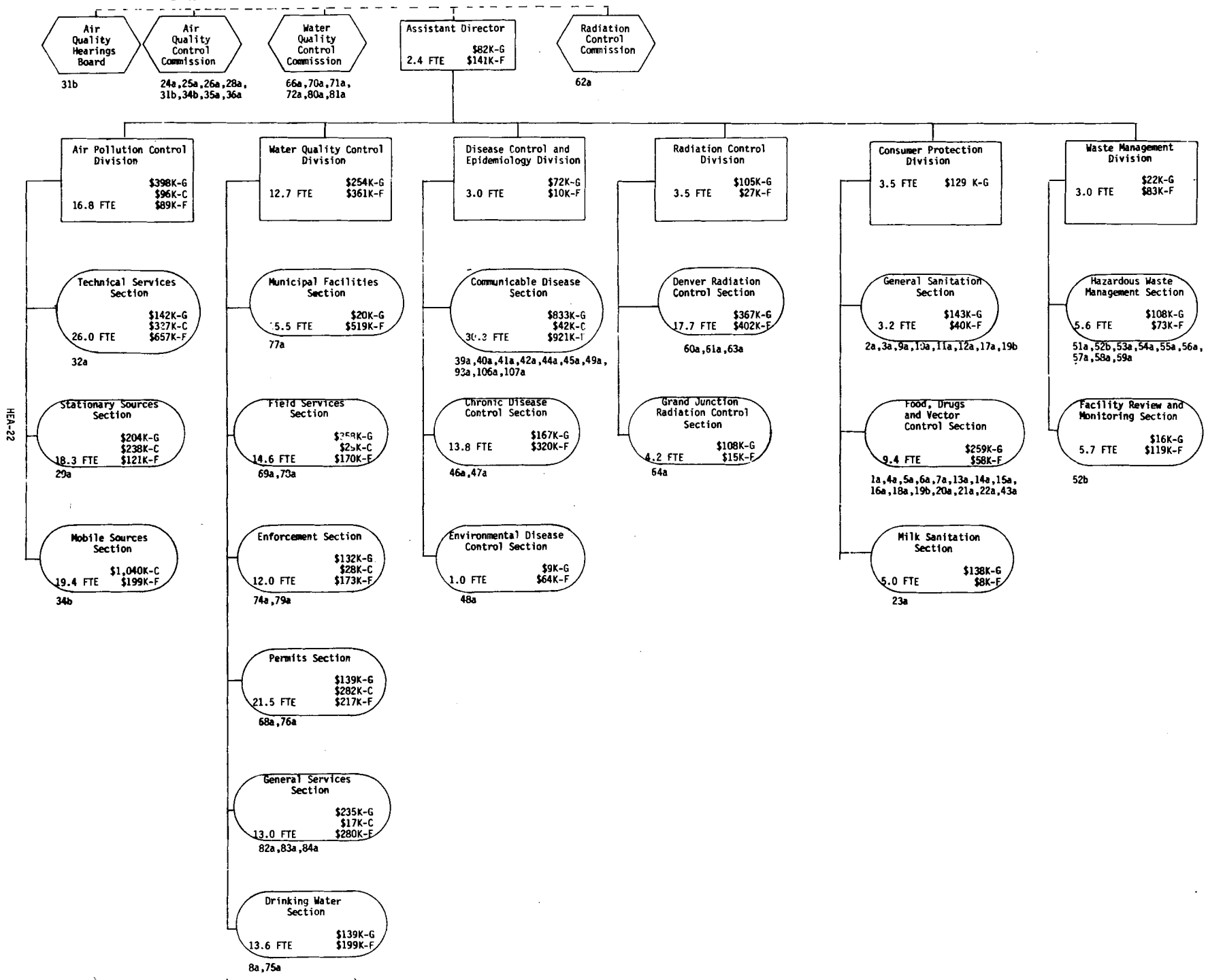

HEA-22

Office Totals:

\$859 K-G
 \$824 K-C
 \$1,841 K-F
 89.6 FTE

OFFICE OF MEDICAL CARE REGULATION AND DEVELOPMENT

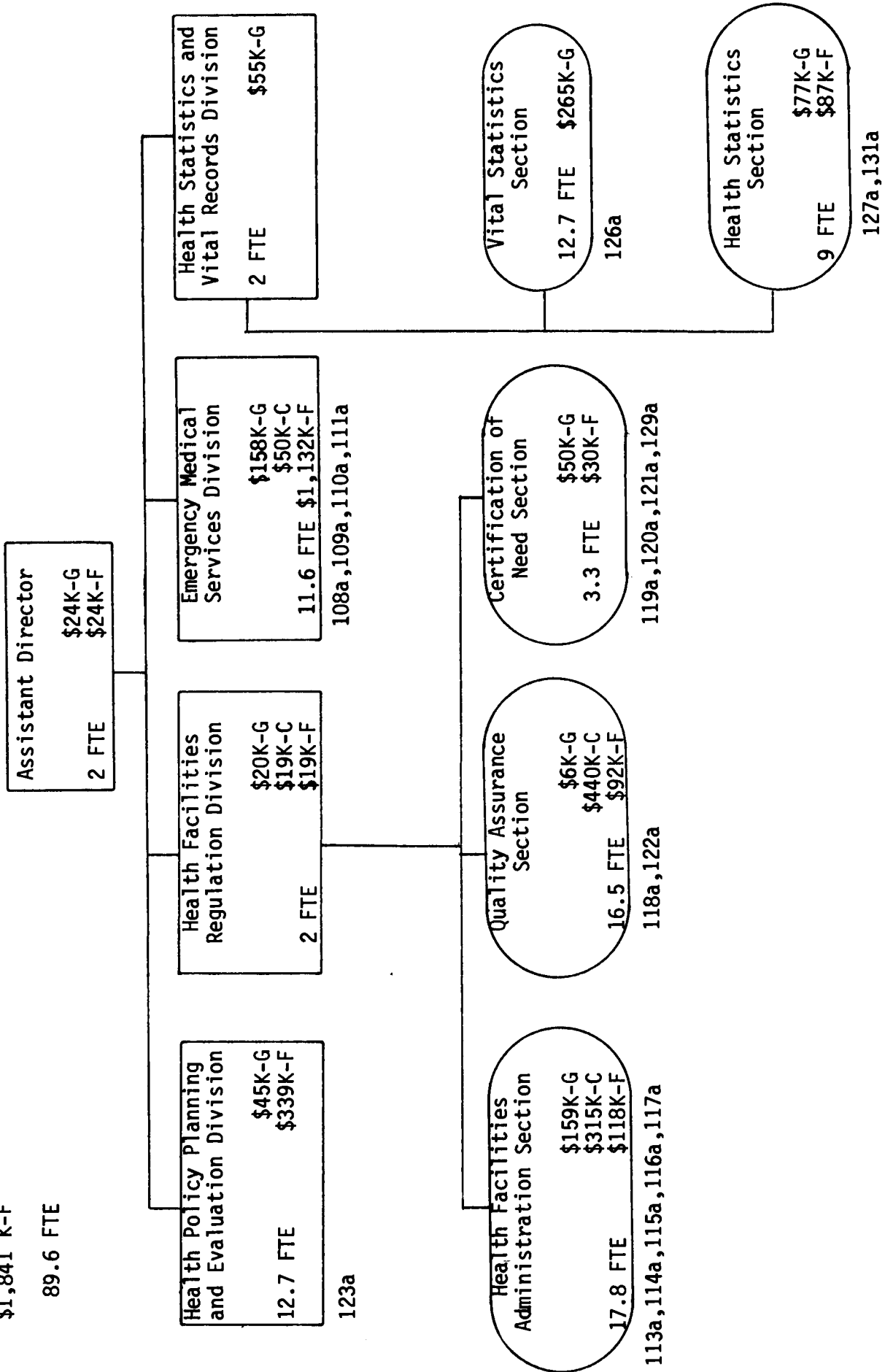

DEPARTMENT OF HIGHER EDUCATION

Page

Administers Programs of Higher Education

Comprehensive Universities and Colleges.....	HE-1
Doctoral Granting Institutions.....	HE-2
Specialized Institutions.....	HE-3
Two-year Colleges.....	HE-3

Promotes the State's History and Culture

HE-3

Provides Coordination and Planning
Services for Higher Education

HE-4

Serves as Governing Bodies for
Institutions of Higher Education

Comprehensive Universities and Colleges.....	HE-6
Doctoral Granting Institutions.....	HE-7
Specialized Institutions.....	HE-9
Two-year Colleges.....	HE-9

DEPARTMENT OF HIGHER EDUCATION

Administers Programs of Higher Education

Comprehensive Universities and Colleges

1. Serve as comprehensive master's degrees granting institutions in a broad range of disciplines. (University of Colorado at Colorado Springs, Adams State College, Western State College; no statutory mandate)
2. Provide comprehensive, broad-based undergraduate programs and master's programs in a selected range of disciplines. (University of Southern Colorado; no statutory mandate)
3. Provide comprehensive baccalaureate degree programs in the liberal arts, sciences, and professions. (Fort Lewis College, Mesa College, Metropolitan State College; no statutory mandate)
4. Affords a curriculum in the sciences, arts, business, education, and vocational education. (Fort Lewis College; 23-52-102, C.R.S. 1973)
5. Offers courses in the liberal arts, and sciences and industrial technology as determined by the State Board of Agriculture. (University of Southern Colorado; 23-55-102, C.R.S. 1973)
6. Serves as an institution of higher education for the purpose of instruction in the science and art of teaching. (Adams State College; 23-51-101, C.R.S. 1973)
7. Provides and offers courses of instruction in the field of liberal arts and sciences, vocational-technical training and adult education. (Mesa College; 23-53-102, C.R.S. 1973)
8. Serves the needs for higher education in the Denver metropolitan area, as well as in the state by providing undergraduate instruction in the liberal arts and sciences, semiprofessional technical education in sciences and engineering technology on a terminal basis, and encourages other state institutions of higher education to offer, by extension, such credit courses as are beyond its scope and function. (Metropolitan State College; 23-54-102, C.R.S. 1973)
9. Offers instruction in teaching and business. (Western State College; 23-56-101, C.R.S. 1973)

Doctoral Granting Institutions

10. Serve as the state's comprehensive research and doctoral granting institutions. (University of Colorado at Boulder and Colorado State University; no statutory mandate)
11. Provides a liberal education and knowledge of the different branches of literature, the arts and sciences. (University of Colorado; 23-20-101, C.R.S. 1973)
12. Offers a program of instruction with emphasis on teaching. (University of Northern Colorado; 23-40-101, C.R.S. 1973)
13. Provides an educational program which emphasizes instruction in agriculture and the natural sciences connected therewith (as the state's land-grant college). (Colorado State University; 23-31-101, C.R.S. 1973)
14. Provides multi-purpose broad-based undergraduate and master's level programs in a selected range of disciplines and has some doctoral programs. (University of Colorado at Denver and University of Northern Colorado; no statutory mandate)
15. Acts as the principal executive officer of the university and carries out the policies and programs established by the board of regents. (President, University of Colorado; 23-20-106, C.R.S. 1973)
16. Keeps a record of concerns to the board of regents: proceedings of the board, disposition of the university's permanent fund and a record of warrants paid. (Secretary to the Board of Regents, University of Colorado; 23-20-107, C.R.S. 1973)
17. Provides clinical care and treatment and health science education and research. (University of Colorado University Hospital; 23-21-103, C.R.S. 1973)
18. Provides care and treatment of residents afflicted with mental disease or disorder or abnormal mental condition. (Colorado Psychiatric Hospital; 23-22-107, C.R.S. 1973)
19. Assists the courts and various state institutions to which children have been committed by providing social and medical care histories. (Children's Diagnostic Center, Psychiatric Hospital; 23-23-101, C.R.S. 1973)
20. Conducts extension service education programs. (State Board of Agriculture, Colorado Cooperative Extension Service; 24-34-105, C.R.S. 1973)

21. Develops procedures for identifying water research projects and collaborating with water user associations and governmental agencies in the formulation of water research projects. (Colorado State University, Colorado Water Resources Research Institute; 23-35-101, C.R.S. 1973)
22. Recommends policy guidelines for implementing the functions of the Water Resources Research Institute. (Colorado State University, Advisory Council on Water Resources Research Policy; 23-35-102, C.R.S. 1973)

Specialized Institutions

23. Provides technical instruction in fields relating to mineral engineering. (School of Mines; 23-41-105, C.R.S. 1973)

Two Year Colleges

24. Provide a two-year college program with unrestricted admissions for high school graduates or students with comparable qualifications. (Arapahoe Community College, Community Colleges of Denver, Lamar Community College, Pikes Peak Community College, Trinidad State Junior College, Morgan Community College, Otero Community College, Pueblo Community College; 23-60-205, C.R.S. 1973)

Promotes the State's History and Culture

25. Advises the governor with respect to the development in the arts and humanities in the state. (Council on Arts and Humanities; 23-9-103, C.R.S. 1973)
26. Proposes methods to encourage private initiative and public interest in the arts and humanities. (Council on Arts and Humanities; 23-9-105 (1) (g), C.R.S. 1973)
27. Functions as trustee for the state and holds the state's collections and property. (State Historical Society; 24-80-202, C.R.S. 1973)
28. Appoints employees of the historical society. (Board of Directors, State Historical Society; 24-80-204, C.R.S. 1973)
29. Accepts and receives gifts and donations to carry out and promote the objective and purposes of the society. (State Historical Society; 24-80-206, C.R.S. 1973)

30. Catalogues and displays items of a scientific or historical nature. (State Historical Society; 24-80-210, C.R.S. 1973)

Provides Coordination and Planning
Services for Higher Education

31. Implements the policies and programs for state-supported higher education in Colorado as those policies are established by the general assembly. (Colorado Commission on Higher Education; 23-1-101, C.R.S. 1973)
32. Suggests solutions for the problems and needs of higher education and maintains liaison with the general assembly and the various boards of higher education. (Advisory Committee to the Colorado Commission on Higher Education; 23-1-103, C.R.S. 1973)
33. Prescribes forms for requests for appropriations from state supported institutions of higher education and studies each submission to determine its consistency with state plans and policies and institutional roles and missions. (Colorado Commission on Higher Education; 23-1-105, C.R.S. 1973)
34. Presents its recommendations on appropriation requests from institutions of high education to the Governor and the Joint Budget Committee. (Colorado Commission on Higher Education; 23-1-105, C.R.S. 1973)
35. Determines whether projects for capital construction are consistent with the roles and functions of the institutions and conform to standards recommended by the commission. (Colorado Commission on Higher Education; 23-1-106, C.R.S. 1973)
36. Reviews the projected five-year building requirements for institutions of higher education. (Colorado Commission on Higher Education; 23-1-106, C.R.S. 1973)
37. Reviews and approves the master planning and program planning for all capital construction projects of institutions of higher education regardless of the source of funding. (Colorado Commission on Higher Education; 23-1-106, C.R.S. 1973)
38. Reviews and approves, consistent with the institutional role and purpose, the proposal for any new program before its establishment. (Colorado Commission on Higher Education; 23-1-107, C.R.S. 1973)
39. Reviews existing or proposed nondegree programs and makes recommendations to the governing boards of the respective

- institutions and the general assembly as to the costs thereof. (Colorado Commission on Higher Education; 23-1-107, C.R.S. 1973)
40. Recommends appropriate roles and functions for institutions of higher education, the elimination of programs, and the establishment of new institutions. (Colorado Commission on Higher Education; 23-1-107, C.R.S. 1973)
 41. Maintains a comprehensive plan for public higher education in the state. (Colorado Commission on Higher Education; 23-1-108, C.R.S. 1973)
 42. Recommends policies to state administrative agencies which recognize the distinct nature and problems of institutions of higher education. (Colorado Commission on Higher Education; 23-1-109, C.R.S. 1973)
 43. With respect to state-supported off-campus instruction, establishes guidelines and standards to be used in the selection of programs and reviews and approves off-campus programs. (Colorado Commission on Higher Education; 23-1-109.5, C.R.S. 1973)
 44. Serves as the state commission for the administration of the "Higher Education Facilities Act" and such other federal programs as are assigned to the commission by the Governor or the general assembly. (Colorado Commission on Higher Education; 23-1-110, C.R.S. 1973)
 45. Determines whether proposed tuition rates are consistent with the level of appropriations and other directives set by the general assembly. (Colorado Commission on Higher Education; 23-1-112, C.R.S. 1973)
 46. Negotiates with contiguous states regarding the establishment of reciprocal agreements for the waiving of nonresidential differentials for Colorado residents attending state institutions of higher education in other states. (Colorado Commission on Higher Education; 23-2-112.5, C.R.S. 1973)
 47. Administers the state act which prohibits those schools which are not accredited from awarding degrees for academic achievement. (Colorado Commission on Higher Education; 23-2-104, C.R.S. 1973)
 48. Administers, with the assistance of institutions of higher education, a program of financial assistance for students. (Colorado Commission on Higher Education; 23-3.3-102, C.R.S. 1973)

49. Establishes and administers an undergraduate fellowship program. (Colorado Commission on Higher Education; 23-3.3-601, C.R.S. 1973)
50. Establishes and sets guidelines for the administration of a grant program for in-state students having financial need. (Colorado Commission on Higher Education; 23-3.5-103, C.R.S. 1973)
51. Appoints three members to the state's student loan guarantee program advisory committee. (Colorado Commission on Higher Education; 23-3.1-105 (1)(c), C.R.S. 1973)
52. Appoints an executive director qualified by substantial training and experience in the field of higher education who serves as the executive officer of the commission as well as the director of the department of higher education. (Colorado Commission on Higher Education; 23-1-104 (2), C.R.S. 1973)
53. Administers the state's loan guarantee program including the establishment of criteria for eligibility of borrowers, lenders, and institutions of higher education to participate in the program, procedures to be followed, enforcement of payback conditions, and the like. (Loan Guarantee Division; 23-3.1-104, C.R.S. 1973)
54. Advises the director of the loan guarantee division and maintains liaison with the general assembly, lenders, and institutions of higher education. (Advisory Committee on Loan Guarantees; 23-3.1-105, C.R.S. 1973)

Serve as Governing Bodies for
Institutions of Higher Education

55. Exercises general supervision of their respective institutions and exclusive control and direction of all funds of and appropriations to their respective institutions unless otherwise provided by law. (All governing boards of higher education; Article VIII, Section 5(2), Colorado Constitution)

Comprehensive Universities and Colleges

56. Provides for a common academic calendar for courses offered at any of the three constituent institutions that comprise the Auraria center. (Board of Directors of the Auraria Higher Education Center; 23-70-103, C.R.S. 1973)

57. Develops and updates on an annual basis a five-year forecast for operational and capital construction costs for the Auraria center. (Board of Directors of the Auraria Higher Education Center; 23-70-104 (1) (e), C.R.S. 1973)
58. Decides interinstitutional disputes. (Board of Directors of the Auraria Higher Education Center; 23-70-104 (1) (f), C.R.S. 1973)
59. Serves as the governing board for Metropolitan State College, Mesa College, Western State College, and Adams State College. (Trustees of the Consortium of State Colleges in Colorado; 23-50-101, C.R.S. 1973)
60. Elects a secretary to the board of trustees of the consortium of state colleges. (Trustees of the Consortium of State Colleges in Colorado; 23-50-105, C.R.S. 1973)

Doctoral Granting Institutions

61. Establishes, maintains, and conducts all or any part of the schools of medicine, dentistry, nursing, and pharmacy, together with hospitals and supporting facilities and programs related to health, at Denver. (Regents of the University of Colorado; Article VIII, Section 5 (1), Colorado Constitution)
62. Elects a president of the University of Colorado. (Regents of the University of Colorado; 23-20-106, C.R.S. 1973)
63. Exercises general supervision over the University of Colorado (including the University of Colorado University Hospital) and control over and direction of all funds. (Regents of the University of Colorado; 23-20-111 and 23-21-101, C.R.S. 1973)
64. Enacts laws for the governance of the University of Colorado. (Board of Regents, University of Colorado; 23-20-112, C.R.S. 1973)
65. Collects rents or charges for the use of university buildings and issues bonds for the construction of new facilities. (Regents of the University of Colorado; 23-20-123 and 129, C.R.S. 1973)
66. Assists those unable to pay the cost of sickle-cell anemia treatment and promotes the study of hemophilia. (Regents of the University of Colorado; 23-21-203, C.R.S. 1973)

67. Establishes tuition and other related policies for those enrolled as dental students or dental clinical specialty students. (Regents of the University of Colorado; 23-20.5-101, C.R.S. 1973)
68. Appoints a director of the University of Colorado Psychiatric Hospital and exercises full control and supervision over the facility. (Regents of the University of Colorado; 23-22-104, C.R.S. 1973)
69. Exercises general supervision and control over the Colorado Children's Diagnostic Center located at the Colorado Psychiatric Hospital. (Regents of the University of Colorado; 23-23-101, C.R.S. 1973)
70. Grant degrees and diplomas to students who have completed the full course of instruction at the University of Northern Colorado. (Trustees of the University of Northern Colorado; 23-40-105, C.R.S. 1973)
71. Appoints a secretary and a treasurer to the board from outside the membership of the board. (State Board of Agriculture; 23-30-105, C.R.S. 1973)
72. Keeps records for the State Board of Agriculture, encourages the formation of agricultural societies and in general promotes the welfare of the university. (Secretary to the State Board of Agriculture; 23-30-107, C.R.S. 1973)
73. Protects the forest resources of the state. (State Board of Agriculture; 23-30-202 (1)(a), C.R.S. 1973)
74. Promotes the control of soil erosion on state forest lands. (State Board of Agriculture; 23-30-202 (1) (b), C.R.S. 1973)
75. Carries out the forestry function of the State Board of Agriculture. (Colorado State Forest Service; 23-30-302, C.R.S. 1973)
76. Chooses a president of the Colorado State University and all other employees necessary and sets their salaries. (State Board of Agriculture; 23-31-109 and 111, C.R.S. 1973)
77. Controls the distribution of funds to agricultural experiment stations within the state. (State Board of Agriculture; 23-33-102, C.R.S. 1973)
78. Coordinates the provision of educational services throughout the state through the cooperative extension service mode. (State Board of Agriculture; 23-34-104, C.R.S. 1973)

Specialized Institutions

79. Exercises control and management of the Colorado School of Mines and the property belonging thereto. (Trustees of the School of Mines; 23-41-104, C.R.S. 1973)

Two-year Colleges

80. Appoints a director of occupational education and a director of community and technical colleges and prescribes the duties and functions of the directors. (State Board for Community Colleges and Occupational Education; 23-60-104 (2) (a), C.R.S. 1973)
81. Recommends to the commission on higher education and the general assembly the location and priorities for establishment of new community and technical colleges. (State Board for Community Colleges and Occupational Education; 23-60-202 (1) (a), C.R.S. 1973)
82. Fixes the tuition and fees charged at community and technical colleges. (State Board for Community Colleges and Occupational Education; 23-60-202 (1) (c), C.R.S. 1973)
83. Approves the appointment of the chief administrative officer of each community and technical college. (State Board for Community Colleges and Occupational Education; 23-60-202 (1) (d), C.R.S. 1973)
84. Provides technical assistance to local junior colleges. (State Board for Community Colleges and Occupational Education; 23-60-203 (1) (c), C.R.S. 1973)
85. Supervises the administration of occupational education programs of the state upon approval of the State Board for Community Colleges and Occupational Education determines the allocation and distribution of state and federal education funds to community and technical colleges, local junior college districts, individual school districts and other agencies. (State Board for Community Colleges and Occupational Education; 23-60-301, C.R.S. 1973)
86. Reviews the proposals of boards of cooperative services for the establishment of new postsecondary programs of occupational education. (State Board for Community Colleges and Occupational Education; 23-60-302, C.R.S. 1973)
87. Prepares and provides for the implementation of state plans for occupational education. (State Board for Community Colleges and Occupational Education; 23-60-304 (1) and (2), C.R.S. 1973)

88. Reviews qualifications of individuals seeking an appointment as chief administrator of each community and technical college. (College Councils; 23-60-206 (2), C.R.S. 1973)
89. Recommends budgets, curriculums, campus development plans and student services, as well as confirms appointments to the professional staff. (College Councils; 23-60-206, C.R.S. 1973)

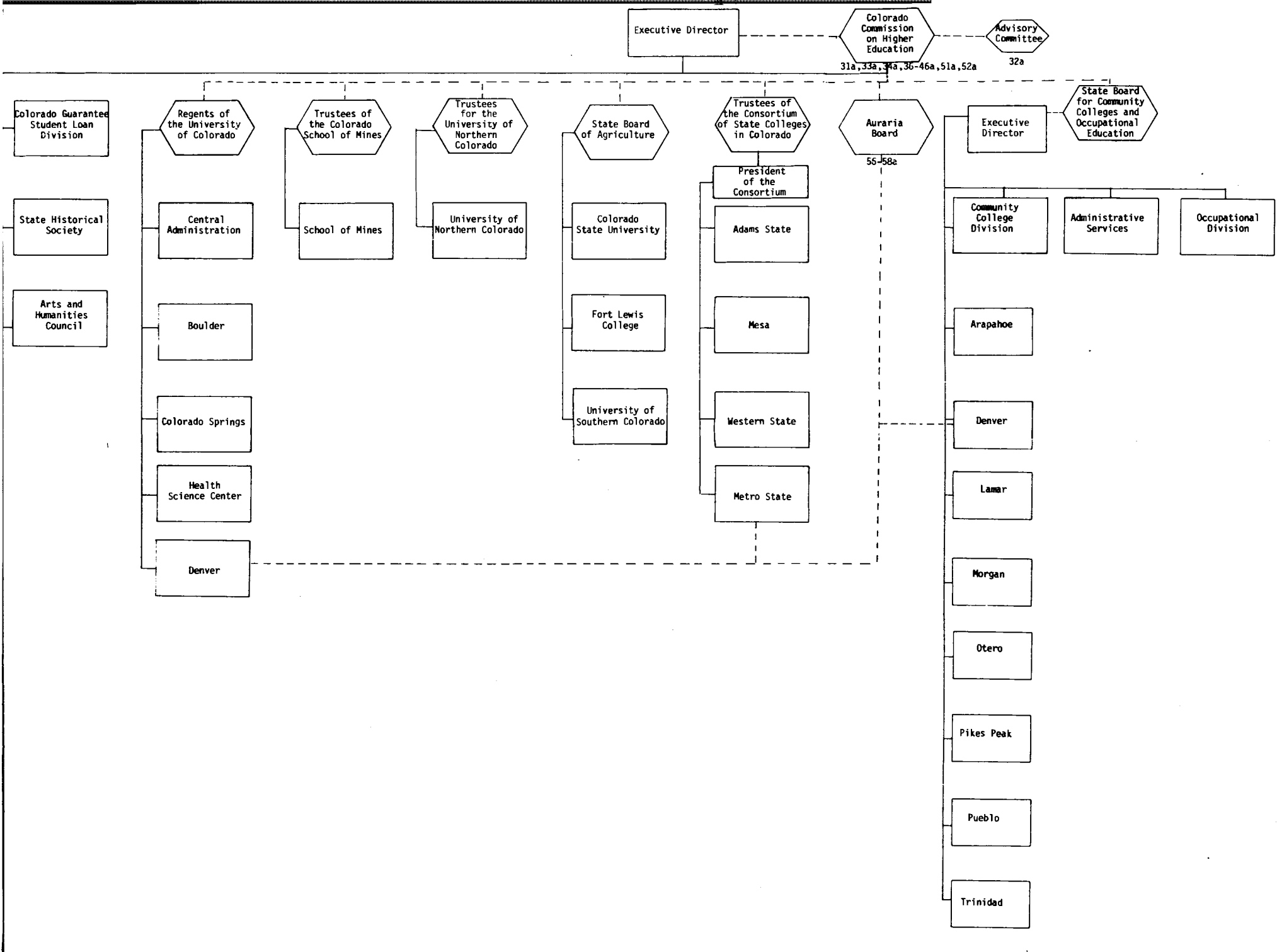

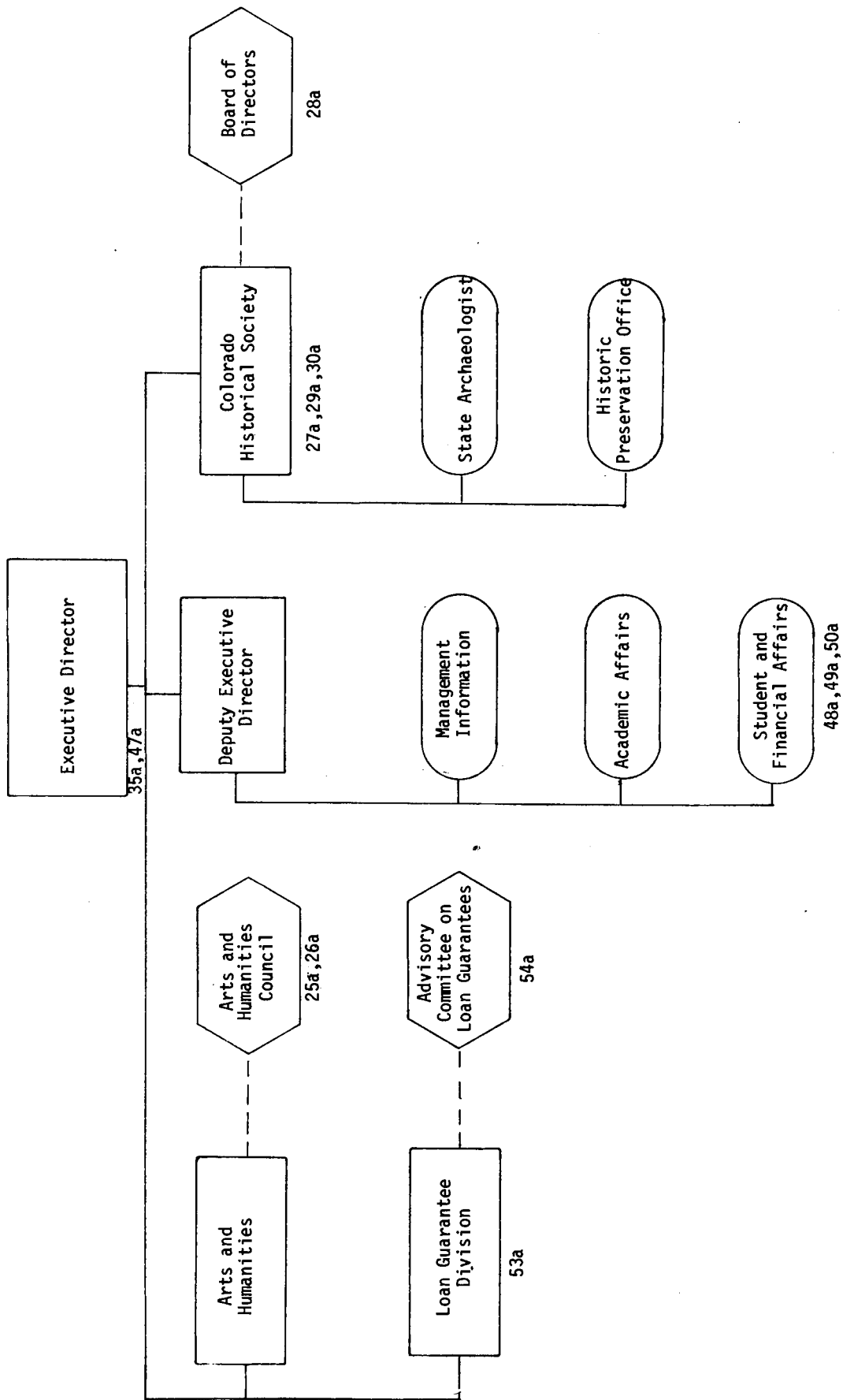

Major Sources of Funding

Tuition -- \$54,436K

Governmental Appropriations:

Federal -- \$5,410K

State -- \$106,134K

Local -- 0

Government Grants -- \$72,974K

Gifts, Grants &

Contracts -- \$17,583K

Auxiliary Enterprises &

Educ. Activities -- \$59,538K

UNIVERSITY OF COLORADO

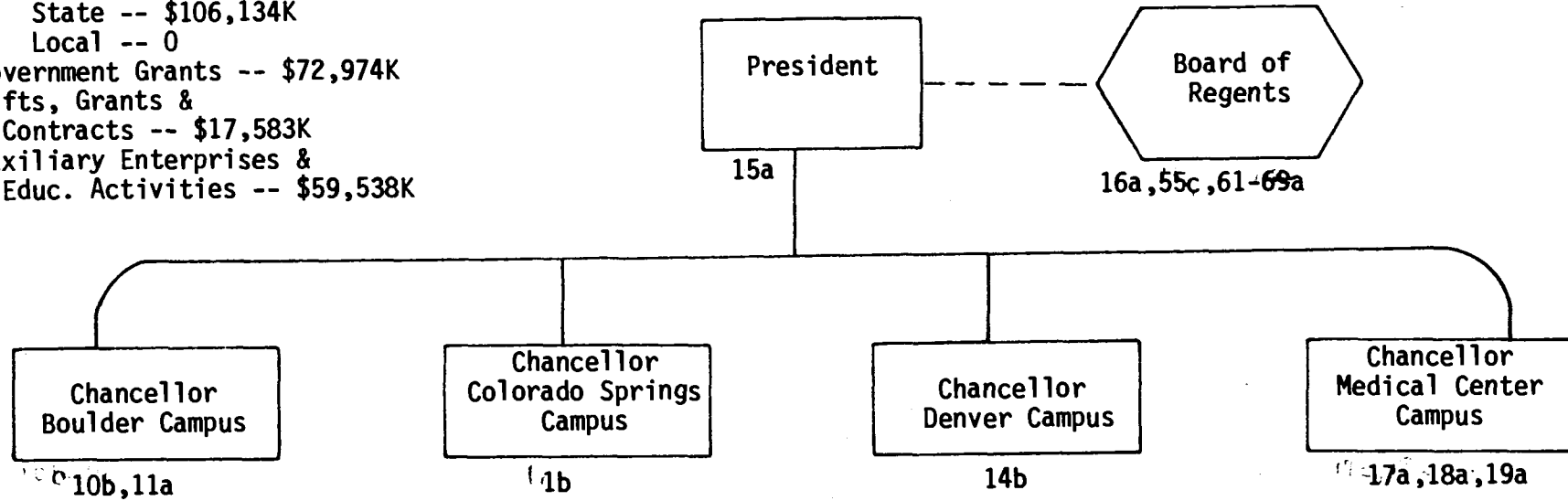

Expenditures by Function:

Instruction	\$96,791K
Research	52,983K
Public Service	3,301K
Academic Support	27,459K
Student Services	7,600K
Plant Oper. and Maint.	16,889K
Institutional Support	20,662K
Scholarships/Fellowships	10,484K
Mandatory Transfers	675K
Auxiliary Enterprises	50,921K

Major Sources of Funding

Tuition -- \$42,105K
 Governmental Appropriations:
 Federal -- \$4,849K
 State -- \$47,351K
 Local -- 0
 Gov't Grants & Contracts:
 Federal -- \$36,014K
 State -- \$8,370K
 Local -- \$469K
 Gifts -- \$4,247K
 Auxiliary Enterprises &
 Educ. Activities -- \$4,267

COLORADO STATE UNIVERSITY, FORT LEWIS, AND UNIVERSITY OF SOUTHERN COLORADO

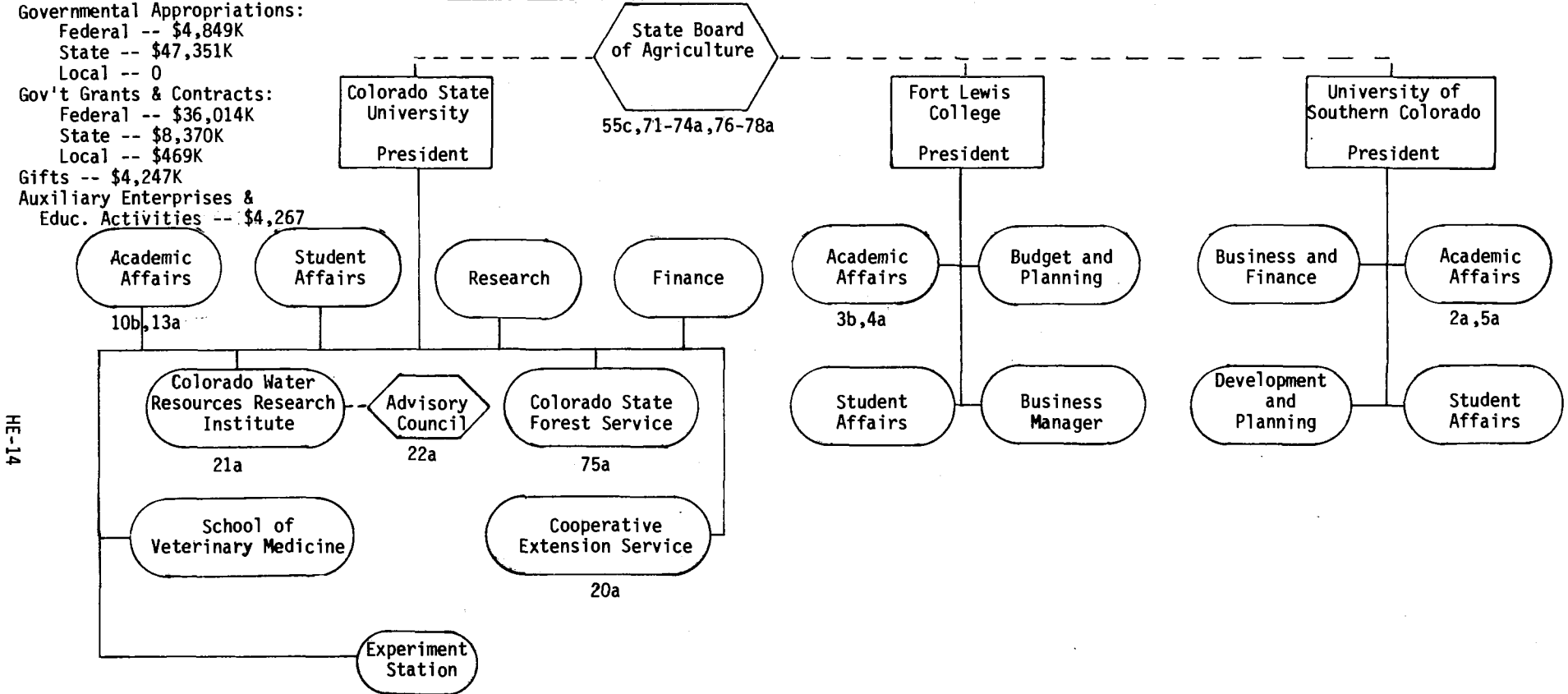

HE-14

Instruction	\$49,096K
Research	38,420K
Public Service	16,879K
Academic Support	8,444K
Student Services	4,213K
Plant Oper. and Maint.	9,823K
Institutional Support	9,039K
Scholarships/Fellowships	6,689K
Mandatory Transfers	173K
Auxiliary Enterprises	29,160K

Instruction	\$4,641K
Research	103K
Public Service	205K
Academic Support	1,416K
Student Services	667K
Plant Oper. and Maint.	1,171K
Institutional Support	808K
Scholarships/Fellowships	852K
Mandatory Transfers	10K
Auxiliary Enterprises	3,910K

Instruction	\$7,119K
Research	351K
Public Service	888K
Academic Support	694K
Student Services	1,654K
Plant Oper. and Maint.	1,961K
Institutional Support	4,156K
Scholarships/Fellowships	2,680K
Mandatory Transfers	0
Auxiliary Enterprises	2,524K

Major Sources of Funding

Tuition -- \$4,283K

Governmental Appropriations:

Federal -- 0

State -- \$8,329K

Local -- 0

Government Grants & Contracts:

Federal -- \$4,236K

State -- \$430K

Local -- 0

Private Gifts, Grants,

Contracts -- \$6,297

COLORADO SCHOOL OF MINES

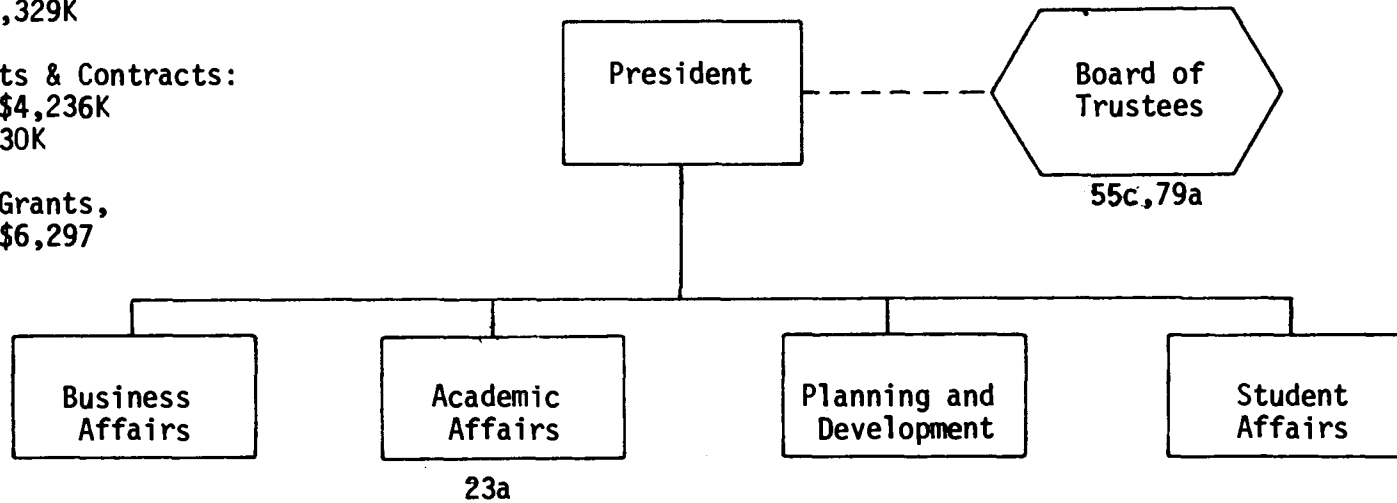

HE-15

Instruction	\$11,176K
Research	5,927K
Public Service	143K
Academic Support	2,415K
Student Services	1,302K
Plant Oper. and Maint.	2,567K
Institutional Support	1,978K
Scholarships/Fellowships	2,436K
Mandatory Transfers	340K
Auxiliary Enterprises	2,797K

Major Sources of Funding

Tuition -- \$13,941K

Governmental Appropriations:

Federal -- 0

State -- \$22,952K

Local -- 0

Government Grants & Contracts:

Federal -- \$3,122K

State -- \$430K

Local -- 0

Auxiliary Enterprises -- \$10,505K

UNIVERSITY OF NORTHERN COLORADO

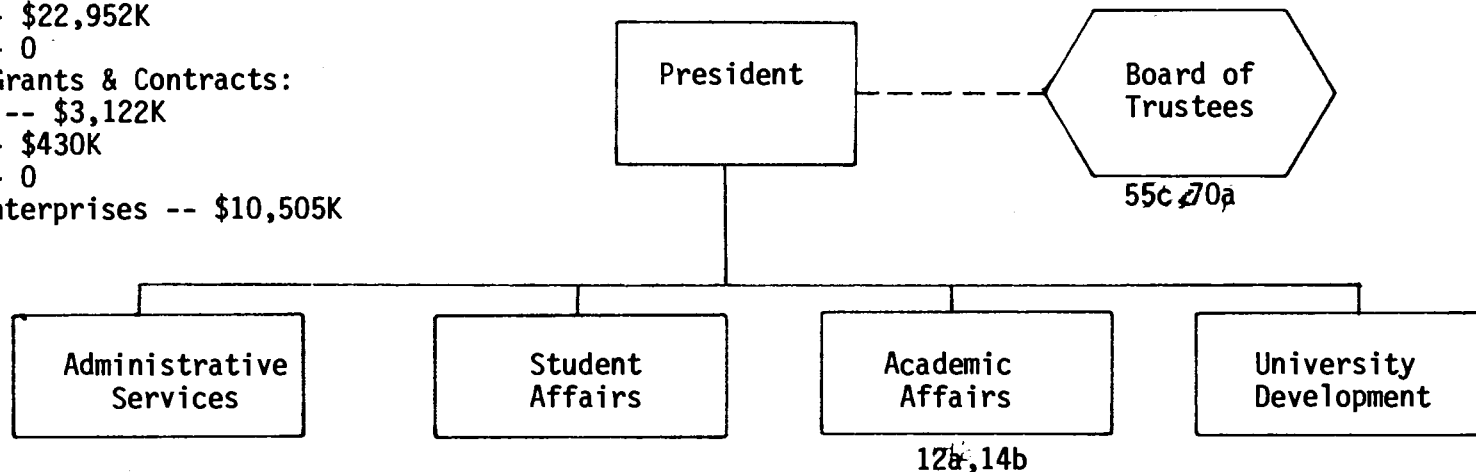

UC-16

Instruction	\$20,016K
Research	42K
Public Service	1,171K
Academic Support	4,180K
Student Services	5,986K
Plant Oper. and Maint.	4,105K
Institutional Support	3,368K
Scholarships/Fellowships	4,978K
Mandatory Transfers	0
Auxiliary Enterprises	10,547K

Major Sources of Funding

Tuition -- \$16,506K

Governmental Appropriations:

Federal -- 0
 State -- \$27,997K
 Local -- 0

Grants & Contracts:

Federal -- \$4,804
 State -- \$1,274K
 Local -- \$120K

Auxiliary Enterprises &

Educ. Activities -- \$14,473

CONSORTIUM OF STATE COLLEGES

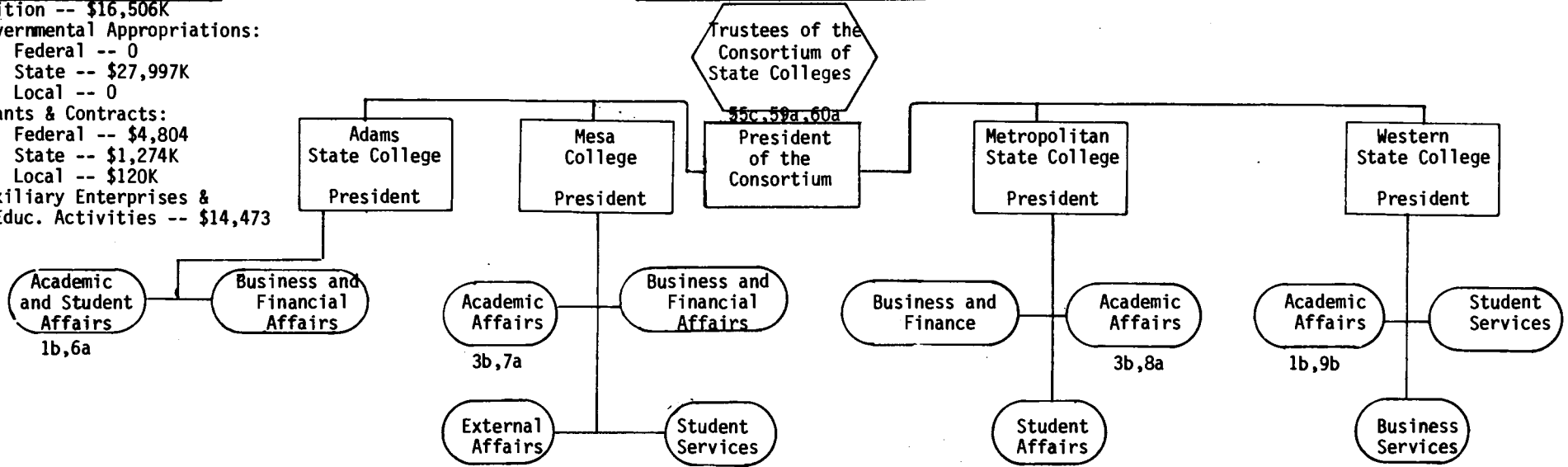

HE-17

Instruction	\$3,772K
Research	0
Public Service	0
Academic Support	327K
Student Services	767K
Plant Oper. and Maint.	1,380K
Institutional Support	959K
Scholarships/Fellowships	1,499K
Mandatory Transfers	149K
Auxiliary Enterprises	2,189K
Other	461K

Instruction	\$4,440K
Research	0
Public Service	73K
Academic Support	817K
Student Services	550K
Plant Oper. and Maint.	998K
Institutional Support	764K
Scholarships/Fellowships	340K
Mandatory Transfers	62K
Auxiliary Enterprises	3,417K

Instruction	\$14,258K
Research	20K
Public Service	370K
Academic Support	1,613K
Student Services	2,649K
Plant Oper. and Maint.	13K
Institutional Support	2,790K
Scholarships/Fellowships	2,237K
Mandatory Transfers	148K
Auxiliary Enterprises	5,471K

Instruction	\$5,335K
Research	42K
Public Teaching	235K
Academic Support	635K
Student Services	1,248K
Plant Oper. and Maint.	1,707K
Institutional Support	707K
Scholarships/Fellowships	562K
Mandatory Transfers	0
Auxiliary Enterprises	3,337K

Major Sources of Funding

Tuition -- \$15,897K
 Governmental Appropriations:
 Federal -- \$265K
 State -- \$29,522K
 Local -- 0
 Grants:
 Federal -- \$6,726K
 State -- \$2,514K
 Local -- \$1,702K
 Auxiliary Enterprises and
 Educ. Activities -- \$7,614K

COMMUNITY COLLEGES

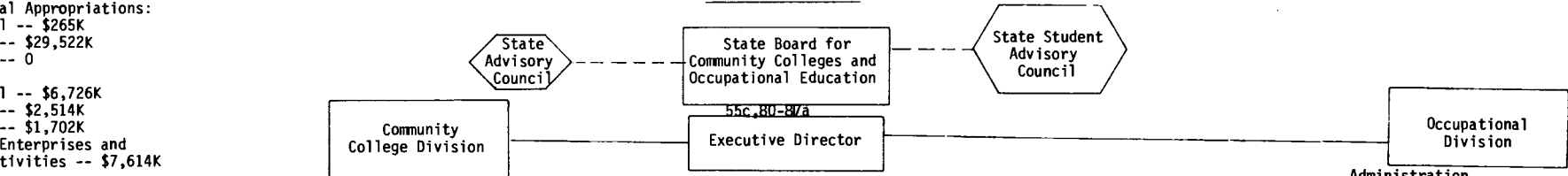

Administration \$ 926K
 Voc. Aid Distributions 13,468K
 Area Vocational Programs 6,517K
 Proprietary School Admin. 150K
 Consumer Homemaking 148K
 Area Voc. School Corrections 713K
 Sponsored Programs 13,923K

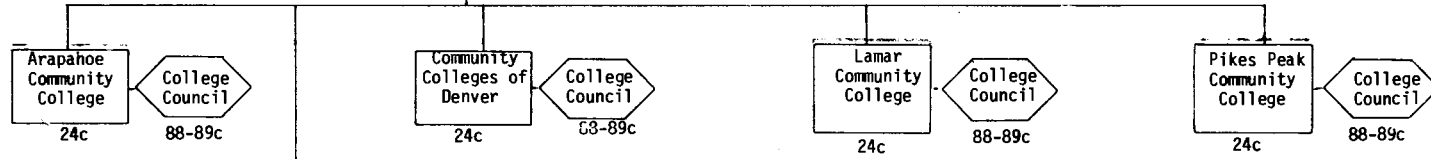

Arapahoe Community College
 24c 88-89c

Instruction	\$3,802K
Research	0
Public Service	0
Academic Support	660K
Student Services	913K
Plant Oper. & Maint.	872K
Institutional Support	1,071K
Scholarships/Fellowships	453K
Mandatory Transfers	421K
Auxiliary Enterprises	683K

Community Colleges of Denver
 24c 88-89c

Instruction	\$11,968K
Research	0
Public Service	0
Academic Support	2,669K
Student Services	1,979K
Plant Oper. & Maint.	1,775K
Institutional Support	2,009K
Scholarships/Fellowships	2,370K
Mandatory Transfers	0
Auxiliary Enterprises	2,267K

Lamar Community College
 24c 88-89c

Instruction	\$840K
Research	0
Public Service	0
Academic Support	151K
Student Services	110K
Plant Oper. & Maint.	313K
Institutional Support	332K
Scholarships/Fellowships	158K
Mandatory Transfers	23K
Auxiliary Enterprises	442K

Pikes Peak Community College
 24c 88-89c

Instruction	\$7,319K
Research	0
Public Service	0
Academic Support	814K
Student Services	710K
Plant Oper. & Maint.	863K
Institutional Support	1,759K
Scholarships/Fellowships	532K
Mandatory Transfers	228K
Auxiliary Enterprises	1,519K

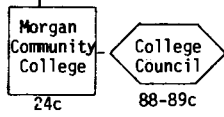

Morgan Community College
 24c 88-89c

Instruction	\$392K
Research	0
Public Service	0
Academic Support	140K
Student Services	100K
Plant Oper. & Maint.	165K
Institutional Support	205K
Scholarships/Fellowships	35K
Mandatory Transfers	29K
Auxiliary Enterprises	78K

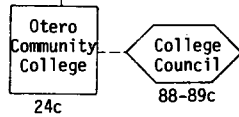

Otero Community College
 24c 88-89c

Instruction	\$2,090K
Research	0
Public Service	0
Academic Support	306K
Student Services	407K
Plant Oper. & Maint.	512K
Institutional Support	251K
Scholarships/Fellowships	177K
Mandatory Transfers	70K
Auxiliary Enterprises	819K

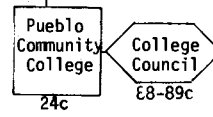

Pueblo Community College
 24c 88-89c

Instruction	\$2,372K
Research	0
Public Service	11K
Academic Support	67K
Student Services	183K
Plant Oper. & Maint.	584K
Institutional Support	439K
Scholarships/Fellowships	200K
Mandatory Transfers	1K
Auxiliary Enterprises	440K

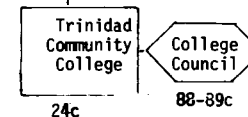

Trinidad Community College
 24c 88-89c

Instruction	\$2,090K
Research	0
Public Service	0
Academic Support	299K
Student Services	407K
Plant Oper. & Maint.	415K
Institutional Support	750K
Scholarships/Fellowships	700K
Mandatory Transfers	165K
Auxiliary Enterprises	1,121K

DEPARTMENT OF HIGHWAYS

Construction and Maintenance of Public Highways of the State

	<u>Page</u>
Assistance to Governmental Entities.....	HI-1
Hazardous Materials Training.....	HI-2
Highway Construction.....	HI-2
Preconstruction Planning.....	HI-2
Highway Construction and Maintenance.....	HI-6
Administration and Supervision.....	HI-6
Highway Use Control.....	HI-8
Policy Direction.....	HI-8
Highway Safety Coordination and Promotion.....	HI-10
Highway and Traffic Studies.....	HI-12
Information Generation and Distribution.....	HI-14
Map Production.....	HI-15
Law Enforcement.....	HI-15
Criminal Investigation.....	HI-17
Protection for Governmental Officials.....	HI-17
Transportation Planning.....	HI-17

Internal Support Services

Administrative Support.....	HI-19
Centralized Services.....	HI-22
Aircraft.....	HI-22
ADP.....	HI-22
Auditing, Budgeting and Accounting.....	HI-22
Building Operations.....	HI-24
Motor Vehicles.....	HI-24
Procurement.....	HI-24
Repair.....	HI-25
Reproduction.....	HI-25
Supplies.....	HI-25
Surplus Disposal.....	HI-25
Management Operations.....	HI-25

DEPARTMENT OF HIGHWAYS

Construction and Maintenance of Public Highways of the State

Assistance to Governmental Entities

1. Acts as consultant on services to the boards of county commissioners. (State Highway Commission; 43-1-105 (1) (h), C.R.S. 1973)
2. Interprets, regulates and enforces provisions of the state Outdoor Advertising Act and federal Highway Beautification Act. (Division of Highways, Staff Right-of-Way Branch; 23 USC 131 and 43-1-401 through 43-1-420, C.R.S. 1973)
3. Coordinates departmental review of project proposals and documents through an A-95 review process and prepares comments reflecting the department's policy and concerns. (Division of Transportation Planning, Impact Evaluation Section; National Environmental Policy Act (1969), Environmental Quality Improvement Act of 1970; CEQ Regulations 40 CFR 1500-1508 (1978); DOT Order 5610.1c (1979); FHPM 7-7-2 23 CFR 771 (1980); FHPM 7-7-1 23 CFR 795; Federal Aid Highway Act (1970) 23 USC 109i; National Flood Insurance Act 42 USC 4001-4128; DOT Order 5650.2; Clean Water Act of 1977 33 USC 1251-1376; DOT Order 5560.1a; 1956 Highway Act Section 116 (c), 23 USC 128; 1962 Highway Act Section 9, 23 USC 134; National Wilderness Preservation System 16 USC 1131-32; Land and Water Conservation Fund Act 16 USC 460L; FHPM 7-7-5 23 CFR 790; Federal Water Pollution Control Act 1972 33 USC 1357-1376; Safe Drinking Water Act 1974 42 USC 300; FHPM 6-7-3 and 67-3-1 23 CFR 650; FHPM 6-7-3-2 23 CFR 650; 40 CFR 120, 122-125, 128-131; 40 CFR 133, 135-136, 148, 228; 1978 Surface Transportation Assistance Act, Section 141 (9); 23 USC 109 (n), 152, 217, 315, and 402 (b), (f); 1966 US DOT Act Section 4 (f), 49 USC 1653 (f); 1966 Highway Act Section 18 23 USC 138; 1968 National Trail Systems Act 16 USC 1241-1249; OMB Circular A-95; 43-1-220 and 43-4-102, C.R.S. 1973)
4. Provides training to law enforcement agencies in detection, apprehension and processing of abusive drinking drivers. (Division of Highway Safety, Alcohol-Driving Countermeasures Section; no state statutory mandate).

Hazardous Materials Training

5. Prepares and conducts training programs on responding to highway accidents involving hazardous materials. (Division of Highway Safety, Colorado Training Institute; 24-42-105, C.R.S. 1973)
6. Assists local governments in developing response capabilities to hazardous material accidents on highways. (Division of Highway Safety, Colorado Training Institute; 24-42-105, C.R.S. 1973)

Highway Construction

Preconstruction Planning

7. Prepares an inventory, description of use, evaluation of plans and assessment of the value of highway department property, except for operating highway rights-of-way. (State Highway Commission; 43-1-105 (1) (m), C.R.S. 1973)
8. Provides that all traffic lanes of state highways designated as diamond lanes for preferential treatment of buses shall also be available for use by vanpools of no less than eight persons. (State Highway Commission; 43-1-105 (1.5), C.R.S. 1973)
9. Selects any public highway, road, or street as part of the federal-aid urban system or as an extension of the federal-aid primary or secondary system in order to qualify such roads for federal-aid funds. (State Highway Commission; 43-2-101 (4) (a), C.R.S. 1973)
10. Establishes escrow accounts in state banks in amounts sufficient to insure payment of any bonds refunded under the provisions of sections 43-3-201 to 43-3-214 for the construction of turnpikes. (State Highway Commission; 43-3-216, C.R.S. 1973)
11. Enters into agreements or contracts with the federal government and other states to construct and operate motor vehicle tunnels between the east and west slopes of Colorado and to enhance the designation of a national interstate and defense highway connection. (State Highway Commission; 43-3-402 and 403, C.R.S. 1973)
12. Applies for and receives funds from the federal government, the State of Colorado or any of its institutions and political subdivisions, political or public corporations of the state, or private investors and issues revenue anticipation warrants for construction, reconstruction, and improvement of highways and bridges. (State Highway Commission; 43-4-302 and 303, C.R.S. 1973)

13. Awards contracts for construction and maintenance of state highways. (Division of Highways, Staff Design Section and Chief Engineer; 43-1-106, C.R.S. 1973)
14. Acquires real property for right-of-way or maintenance purposes or other purposes authorized by law. (Division of Highways, Staff Right-of-Way Section and also Chief Engineer; 43-1-107, C.R.S. 1973)
15. Prepares cost estimates for projects using maintenance funds. (Division of Highways, Staff Design Section; 24-92-109 and 24-16-105, C.R.S. 1973)
16. Prepares input to the Five Year Highway Construction/Improvement Program. (Division of Highways, Field Districts; 43-4-102 (1) (a), C.R.S. 1973)
17. Designs and prepares complete structural plans and specifications; formulates standard bridge plans; and reviews consulting engineers' plans. (Division of Highways, Staff Bridge Design Section; 43-1-105 (1) (i), C.R.S. 1973)
18. Obtains construction program approval from the Federal Highway Administration (FHWA) and obligates funds on federal aid highway projects. (Division of Highways, Staff Design Section; 23 CFR 650.112)
19. Prepares complete plans, specifications, and estimates for highway construction projects. (Division of Highways, Staff Design Section; 23 CFR 630, Subpart B)
20. Secures FHWA authorization to proceed with each phase of work on federal aid projects. (Division of Highways, Staff Design Section; 23 CFR 630.114)
21. Secures or makes proper appraisals of all property to be acquired for rights-of-way. (Division of Highways, Staff Right-of-Way Section; FHPM, Volume 7)
22. Acquires land and improvements for highway purposes. (Division of Highways, Staff Right-of-Way Section, and Field Districts; 43-1-208 and 43-1-210, C.R.S. 1973)
23. Assists in making administrative settlement and relocation appeals. (Division of Highways, Staff Right-of-Way Section; FHPM, Volume 7)
24. Reviews applications of individuals displaced by highway construction for relocation assistance. (Division of Highways, Staff Right-of-Way Section and Chief Engineer; 43-1-309, C.R.S. 1973)

25. Relocates families, farms and businesses dislocated by highway construction. (Division of Highways, Staff Right-of-Way Section; 43-1-304, C.R.S. 1973)
26. Monitors all highway construction projects through preconstruction phases. (Division of Highways, Project Scheduling Section; no state statutory mandate)
27. Issues construction project bid plans for the department. (Division of Administration, Administrative Services Section; 24-92-103 (2), C.R.S. 1973)
28. Distributes notice of construction projects for bid. (Division of Administration, Administrative Services Section; 24-92-103 (3), C.R.S. 1973)
29. Performs pre-award evaluations of potential contractors on non-bid type contracts. (Office of Management and Budget, Audit Section; 41 CFR 1-3)
30. Conducts field inventories for the Sufficiency Study. (Division of Transportation Planning, Planning Support Section, Mapping and Field Operations Unit; 43-2-136, C.R.S. 1973)
31. Conducts field work for all traffic counting operations; maintains permanent and portable traffic counters in operable condition. (Division of Transportation Planning, Planning Support Section and Program Development Section, Mapping and Field Operations Unit; no state statutory mandate)
32. Prepares resolutions for the Highway Commission's action for highway additions or deletions, state highway functional classification changes, and urban boundary changes. (Division of Transportation Planning, Planning Support Section, Mapping and Field Operations Unit; 43-1-105 (1) (b), C.R.S. 1973)
33. Performs in-house research including that associated with experimental features on highway construction projects. (Division of Transportation Planning, Planning Support Section, Research Coordination Unit; 23 USC 307 and 315; 49 CFR 1.48 (b); 23 CFR 635.411)
34. Prepares a five year highway construction/improvement program which includes identification of projects for construction or improvement. (Division of Transportation Planning, Program Development Section, Program Planning Unit; 43-1-105 (1) (a), 43-2-136 through 43-2-138, C.R.S. 1973; Procedural Directive #1604.2; Department of Highways Action Plan, 1981)

35. Prepares an interstate cost estimate detailing all projects eligible for interstate construction and estimates funds necessary to complete the required work. (Division of Transportation Planning, Program Development Section, Program Planning Unit; 23 USC 104 (b) (5))
36. Develops and maintains a pavement management system to monitor the condition of roadways within the state and recommends improvement activities necessary to maintain the highway system in satisfactory condition. (Division of Transportation Planning, Program Development Section, Program Planning Unit; no state statutory mandate)
37. Prepares ecological, archaeological, historical, economic, energy, air and water quality, and cost/benefit assessments for all major and intermediate highway projects and selected minor projects. (Division of Transportation Planning, Impact Evaluation Section; see mandate for #39 below)
38. Reviews environmental and design documents prepared by field districts and by other agencies. (Division of Transportation Planning, Impact Evaluation Section, Human and Physical Resources Unit; see mandate for #39 below)
39. Screens the department's five year highway construction/improvement program to estimate environmental, social, and economic impacts on all upcoming projects. (Division of Transportation Planning, Impact Evaluation Section, Human and Physical Resources Unit; National Environmental Policy Act (1969); Environmental Quality Improvement Act of 1970; CEQ Regulations 40 CFR 1500-1508 (1978); DOT Order 5610.1c (1979); Clean Air Act (1963) as amended (1977) 42 USC 7400; Federal Aid Highway Act (1970) 23 USC 109i; FHPM 7-7-2 23 CFR 771 (1980); Noise Control Act (1972) 86 USC 1234-1250; FHPM 7-7-3 23 CFR 772; Emergency Highway Energy Conservation Act 23 USC 154; Executive Orders 12185 3 USC 301; Wild and Scenic Rivers Act 16 USC 1271-1287; 43 CFR 6223; National Flood Insurance Act 42 USC 4001-4128; DOT Order 5650.2; DOT Order 5660.1a; Act for Preservation of American Antiquities (1906) 16 USC 431-433; Historic Sites and Buildings Act (1935) 16 USC 461; National Historic Preservation Act of 1966 (as amended) Section 106 16 USC 470 (f); Preservation of Historic and Archaeological Data 1974 16 USC 469; Executive Order 11593; 36 CFR 60-69, 800; Rivers and Harbors Act of 1899 33 USC 1151-1376; Federal Water Pollution Control Act 1972 33 USC 1357-1376; Safe Drinking Water Act 1974 42 USC 300; Clean Water Act of 1977 33 USC 1251-1376; Endangered Species Act of 1973 16 USC 1531-1543; 50 CFR 17; 50 CFR 402; 1973 Highway Act Sections 124, 209a, and 228; 1978 National Energy Policy Act Section 682; 1958 Fish and Wildlife Coordination Act 16 USC 661-666; 50 CFR 410; 43-1-120 and 43-4-102, C.R.S. 1973)

Highway Construction and Maintenance

Administration and Supervision

40. Establishes and collects fees, fares, and tolls for traveling through tunnels. (State Highway Commission; 43-3-413 (1), C.R.S. 1973)
41. Establishes, opens, relocates, widens, or alters portions of the state highways. (Division of Highways, Field Districts and Chief Engineer; 43-1-208, C.R.S. 1973)
42. Supervises construction, the letting of contracts, and preparation and approval of specifications and plans for any highway construction or improvement involving an agreement between the federal government and the State of Colorado. (Division of Highways, Field Districts and Chief Engineer and Staff Construction Section; 43-1-223, C.R.S. 1973)
43. Reviews plans and designs for structures owned by others requiring easements on state highway rights-of-way. (Division of Highways, Staff Bridge Design Section; no state statutory mandate)
44. Divides freeways into separate roadways by the construction of raised curbing, central dividing sections, or other physical separations. (Division of Highways, Field Districts and Chief Engineer; 43-3-102, C.R.S. 1973)
45. Closes any street or county highway to perform work. (Division of Highways, Field Districts and Chief Engineer; 43-3-103, C.R.S. 1973)
46. Lays out and constructs local service roads whenever a highway has been designated as a freeway. (Division of Highways, Field Districts and Chief Engineer; 43-3-105, C.R.S. 1973)
47. Reviews overload permit requests for extra heavy loads. (Division of Highways, Staff Bridge Design Section; 42-4-409, C.R.S. 1973)
48. Reviews subdivision drainage plans affecting state highways. (Division of Highways, Staff Design Section; 43-2-147, C.R.S. 1973)
49. Administers specific highway construction contracts including surveying, inspecting, testing, and documentation. (Division of Highways, Field Districts; 43-1-223, C.R.S. 1973)

50. Establishes priorities for contract payments for highway construction work. (Division of Highways, Field Districts and Staff Construction Section; FHPM 6-4-1-6)
51. Supervises statewide highway construction program. (Division of Highways, Field Districts and Staff Construction Section; 43-1-223, C.R.S. 1973)
52. Tests and monitors various materials used in construction and maintenance of State highways. (Division of Highways, Field Districts and Staff Materials Section; 43-1-105 (1) (i), C.R.S. 1973)
53. Performs field and office studies of geologic problems as related to state highway projects. (Division of Highways, Staff Materials Section; 43-1-105 (1) (i), C.R.S. 1973)
54. Prepares plans and specifications for traffic control signs, markings, and traffic signals for new construction projects. (Division of Highways, Staff Traffic and Safety Projects Section; no state statutory mandate)
55. Supervises all highway construction project activities. (Division of Highways, Field Districts; 43-1-106, C.R.S. 1973)
56. Formulates policies and procedures governing maintenance operations. (Division of Highways, Staff Maintenance Section; 43-1-106, C.R.S. 1973)
57. Inspects maintenance field operations to ensure compliance with essential procedures. (Division of Highways, Staff Maintenance Section; no state statutory mandate)
58. Coordinates issuance of permits for overweight and oversize loads. (Division of Highways, Staff Maintenance Section; 42-4-401 through 409, C.R.S. 1973)
59. Maintains highway surfaces, drainages and rights-of-way. (Division of Highways, Field Districts; Division of Highways, Manual of Maintenance Procedures, Revised Edition 1982)
60. Maintains traffic services including signs, lighting, and striping on state highways. (Division of Highways, Field Districts; Manual on Uniform Traffic Control Devices (MUTCD) published by U.S. Department of Transportation, Federal Highway Administration)
61. Monitors the various phases of rail project development from the formation of third party agreements to the rail project construction completion. (Division of Transportation Planning, Planning Support Section, Rail Programs Unit; PL94-210, PL95-607; 43-1-801, 43-1-802, C.R.S. 1973)

62. Monitors and tracks highway project developments to expedite compliance with schedules. (Division of Transportation Planning, Impact Evaluation Section; National Environmental Policy Act (1969), Environmental Quality Improvement Act of 1970; CEQ Regulations 40 CFR 1500-1508 (1978); DOT Order 5610.1c (1979); FHPM 7-7-2 23 CFR 771 (1980); FHPM 7-7-1 23 CFR 795; Federal Aid Highway Act (1970) 23 USC 109i; National Flood Insurance Act 42 USC 4001-4128; DOT Order 5650.2; Clean Water Act of 1977 33 USC 1251-1376; DOT Order 5660.1a; 1956 Highway Act Section 116(c), 23 USC 128; 1962 Highway Act Section 9, 23 USC 134; National Wilderness Preservation System 16 USC 1131-32; Land and Water Conservation Fund Act 16 USC 460L; FHPM 7-7-5 23 CFR 790; Federal Water Pollution Control Act 1972 33 USC 1357-1376; Safe Drinking Water Act 1974 42 USC 300; FHPM 6-7-3 and 67-3-1 23 CFR 650; FHPM 6-7-3-2 23 CFR 650; 40 CFR 120, 122-125, 128-131; 40 CFR 133, 135-136, 148, 228; 1978 Surface Transportation Assistance Act, Section 141 (9); 23 USC 109 (n), 152, 217, 315, and 402 (b) (f); 1966 US DOT Act Section 4 (f), 49 USC 1653 (f); 1966 Highway Act Section 18 23 USC 138; 1968 National Trail Systems Act 16 USC 1241-1249; OMB Circular A-95; 43-1-220 and 43-4-102, C.R.S. 1973)

Highway Use Control

63. Administers the highway access law and code. (Division of Highways, Staff Right-of-Way Section; 43-2-147, C.R.S. 1973)
64. Controls access to the state highway system. (Division of Highways, Field Districts; 43-2-147, C.R.S. 1973)
65. Administers right-of-way disposal and disputes. (Division of Highways, Field Districts; 43-1-309, C.R.S. 1973)

Policy Direction

66. Formulates general ~~policy~~ with respect to the management, construction, and maintenance of public highways in the state. (State Highway Commission; 43-1-105 (1) (a), C.R.S. 1973)
67. Receives delegations, including county commissioners, interested in the formulation of general policy with respect to the management, maintenance and construction of highways. (State Highway Commission; 43-1-105 (1) (a), C.R.S. 1973)
68. Conducts studies to guide the Chief Engineer concerning the highway needs of the state. (State Highway Commission; 43-1-105 (1) (b), C.R.S. 1973)

69. Prescribes the administrative practices to be followed by the Chief Engineer in the performance of any duty imposed on him by law. (State Highway Commission; 43-1-105 (1) (c), C.R.S. 1973)
70. Advises and makes recommendations to the Governor and General Assembly relative to the highway policy of the state. (State Highway Commission; 43-1-105 (1) (d), C.R.S. 1973)
71. Requires the Chief Engineer to furnish reports, statistics, information, or assistance the commission may request in studying any particular highway problems. (State Highway Commission; 43-1-105 (1) (e), C.R.S. 1973)
72. Advises the Chief Engineer of any highway problem with which he may be confronted. (State Highway Commission, 43-1-105 (1) (f), C.R.S. 1973)
73. Promulgates and adopts budgets for all state highways, divisions of the state Department of Highways and highway programs including construction priorities and the approval of extensions or abandonments of the state highway system. (State Highway Commission; 43-1-105 (1) (g), C.R.S. 1973)
74. Makes all necessary orders, rules and regulations regarding the operations of the Department of Highways. (State Highway Commission; 43-1-105 (1) (j), C.R.S. 1973)
75. Performs necessary functions in the construction, maintenance, and improvement of the state highways and public roads serving state parks and recreation areas as well. (State Highway Commission; 43-1-105 (1) (i) and (k), C.R.S. 1973)
76. Performs necessary tasks in the construction, maintenance, and improvement of recreational trails along and across new or existing state and interstate highways. (State Highway Commission; 43-1-105 (1) (l), C.R.S. 1973)
77. Adopts and approves standards of construction for all state highways. (State Highway Commission; 43-2-107, C.R.S. 1973)
78. Establishes priorities for construction of the state highway system using a sufficiency rating system to establish such priorities. (State Highway Commission; 43-2-136, C.R.S. 1973)
79. Makes reasonable regulations for the installation, construction, maintenance, repair, renewal, and relocation of utility facilities. (State Highway Commission; 43-1-225, C.R.S. 1973)

80. Computes annual percentages for allocation of Highway Users Tax Funds to all cities and counties. (Division of Transportation Planning, Planning Support Section, Statistics and Special Studies Unit; 43-4-207 and 43-4-208, C.R.S. 1973)
81. Coordinates interdisciplinary review of departmental environmental and design documents and insures compliance with federal and state laws and regulations and with departmental policy and procedural requirements. (Division of Transportation Planning, Impact Evaluation Section; see mandates for #82 below)
82. Reviews and concurs in the department's highway project categorizations and proposed scope of landscape clearance to insure compliance with federal and state laws and regulations and departmental policy and procedural requirements. (Division of Transportation Planning, Impact Evaluation Section; National Environmental Policy Act (1969), Environmental Quality Improvement Act of 1970; CEQ Regulations 40 CFR 1500-1508 (1978); DOT Order 5610.1c (1979); FHPM 7-7-2 23 CFR 771 (1980); FHPM 7-7-1 23 CFR 795; Federal Aid Highway Act (1970) 23 USC 109i; National Flood Insurance Act 42 USC 4001-4128; DOT Order 5650.2; Clean Water Act of 1977 33 USC 1251-1376; DOT Order 5660.1a; 1956 Highway Act Section 116 (c), 23 USC 128; 1962 Highway Act Section 9, 23 USC 134; National Wilderness Preservation System 16 USC 1131-32; Land and Water Conservation Fund Act 16 USC 460L; FHPM 7-7-5 23 CFR 790; Federal Water Pollution Control Act 1972 33 USC 1357-1376; Safe Drinking Water Act 1974 42 USC 300; FHPM 6-7-3 and 67-3-1 23 CFR 650; FHPM 6-7-3-2 23 CFR 650; 40 CFR 120, 122-125, 128-131; 40 CFR 133, 135-136, 148, 228; 1978 Surface Transportation Assistance Act, Section 141 (9); 23 USC 109 (n), 152, 217, 315, and 402 (b) (f); 1966 US DOT Act Section 4 (f), 49 USC 1653 (f); 1966 Highway Act Section 18 23 USC 138; 1968 National Trail Systems Act 16 USC 1241-1249; OMB Circular A-95; 43-1-220 and 43-4-102, C.R.S. 1973))

Highway Safety Coordination and Promotion

83. Advises the director of the Division of Highway Safety in the promotion of highway safety in the state. (Division of Highway Safety, Governor's Traffic and Safety Advisory Committee; 24-42-102, C.R.S. 1973)
84. Prepares and reviews recommendations for traffic control devices and related safety improvements on the state highway system. (Division of Highways, Staff Traffic and Safety Projects Section; no state statutory mandate)

85. Consults with state agencies, political subdivisions, and with citizen groups to formulate current and long-range plans and programs of traffic safety; and reviews state and local programs/projects to ensure compliance with established policies/goals. (Division of Highway Safety, Office of Director ; 24-42-103 (2) (a), C.R.S. 1973)
86. Deals with the federal government with respect to federal highway traffic safety legislation, programs, and activities. (Division of Highway Safety, Officer of Director; 24-42-103 (2) (b), C.R.S. 1973; 23 USC 402)
87. Coordinates the activities of state departments, institutions and agencies, and political subdivisions relating to traffic safety. (Division of Highway Safety, Office of Director; 24-42-103 (2) (b), C.R.S. 1973)
88. Coordinates state traffic safety program activity in the following National Standard Areas: motor vehicle inspection and registration; motorcycle safety; driver education; driver licensing; traffic courts; alcohol in relation to highway safety; identification and surveillance of accident locations; traffic records; emergency response services/training; highway design, construction and maintenance; traffic control devices; pedestrian safety; police traffic services; debris hazard control; pupil transportation safety; and accident investigation. (Division of Highway Safety, Office of Director; 23 USC 401-406)
89. Directs the administration of the federal highway safety grant-in-aid program. (Division of Highway Safety, Office of Director; 23 USC 402; no state statutory mandate)
90. Designs, formulates, administers and implements long and short range plans for the state's comprehensive programs in traffic safety. (Division of Highway Safety, State and Community Programs Section; 24-42-103 (2) (a), C.R.S. 1973)
91. Assists in development, administration, and implementation of the state's Highway Safety Plan. (Division of Highway Safety, State and Community Programs Section; 24-42-103, C.R.S. 1973)
92. Develops, reviews and coordinates local action programs for traffic safety. (Division of Highway Safety, State and Community Programs Section; 24-42-103, C.R.S. 1973)
93. Conducts safety inspections of school buses. (Division of State Patrol, Field Operations, Field Districts; 43-5-103 (2) (a), C.R.S. 1973)

94. Implements, monitors and evaluates a statewide alcohol and drug driving safety program. (Division of Highway Safety, Alcohol-Driving Countermeasurers Section; 42-4-1202 (5), C.R.S. 1973)

Highway and Traffic Studies

95. Performs traffic signal warrant studies, speed zoning control studies and accident analysis. (Division of Highways, Staff Traffic and Safety Projects Section; 23 USC 152)
96. Prepares monitoring plans and monitors the 55 mph speed limit, and prepares quarterly reports and annual certification. (Division of Highways, Staff Traffic and Safety Projects Section; 23 USC 154 and 42-4-1001 (7)(a), C.R.S. 1973)
97. Performs traffic engineering studies (traffic counts, accident site investigations, etc.). (Division of Highways, Field Districts; 23 USC)
98. Conducts the field operations of traffic studies such as: truck size and weight, rural origin and destination, and urban travel time. (Division of Transportation Planning, Planning Support Section, Mapping and Field Operations Unit and Program Development Section; HPPM Volume 1, Chapter 1, Paragraph 5)
99. Collects, evaluates and publishes statistics of receipts and expenditures for highway, road, and street purposes for all cities and counties and the Department of Highways. (Division of Transportation Planning, Planning Support Section; 43-2-120, 43-2-121, 43-2-132, C.R.S. 1973)
100. Conducts and coordinates all functions required by FHWA for fulfilling requirements of the Highway Performance Monitoring System (HPMS). (Division of Transportation Planning, Planning Support Section, Statistics and Special Studies Unit; FHWA requirement)
101. Maintains and updates records of the state highway system, county road system, and city street system for each municipality in the state. (Division of Transportation Planning, Planning Support Section, Statistics and Special Studies Unit; 43-4-207, 43-4-208, C.R.S. 1973)
102. Inspects, rates, and inventories listing of all bridges on the state highway system and reports the inventory of all bridges in Colorado to the federal government. (Division of Highways, Staff Bridge Design Section; 23 CFR 650.301 to 650.311)

103. Compiles and reports annual statistics to the federal government on motor fuel consumption, vehicle registrations, licenses, and taxes; assembles statistics on department capital outlay, receipts, disbursements, and balances; and provides annual statistics for all cities and counties of receipts and expenditures for highway, road, and street purposes. (Division of Transportation Planning, Planning Support Section, Statistics and Special Studies Unit; 43-2-120, 43-2-132, C.R.S. 1973, FHWA requirement)
104. Maintains and edits an inventory of all railroad-highway crossings; performs field inspections of railroad-highway crossings statewide; and develops and publishes various reports. (Division of Transportation Planning, Planning Support Section, Rail Programs Unit; Section 203 (a) of the 1973 Highway Safety Act, as amended, and paragraph 6a (1) FHPM 8-2-3)
105. Analyzes, edits and reports traffic related data. (Division of Transportation Planning, Planning Support Section, Traffic Surveys Unit; HPPM Volume 1, Chapter 1, Paragraph 5)
106. Develops traffic volume and distribution factors. (Division of Transportation Planning, Planning Support Section, Traffic Surveys Unit; no state statutory mandate)
107. Forecasts travel-related information required for design of highway construction projects. (Division of Transportation Planning, Planning Support Section; HPPM Volume 1, Chapter 1, Paragraph 5)
108. Analyzes traffic conditions for highway or street capacity. (Division of Transportation Planning, Planning Support Section, Traffic Surveys Unit; no state statutory mandate)
109. Coordinates all research activities performed under the Highway Planning and Research (HPR) Work Program, state studies, or other FHWA programs. (Division of Transportation Planning, Planning Support Section, Research Coordination Unit; 23 USC 307 (c) and 315; 49 CFR 1.48 (b); Department of Highways Procedural Directives #1600.2 and #1600.3)
110. Evaluates research technology developed by other state highway departments. (Division of Transportation Planning, Planning Support Section, Research Coordination Unit; 23 USC 307 (c) and 315; 49 CFR 1.48 (b); Department of Highways Procedural Directive #3.1)

111. Provides technical assistance for air quality and transportation noise analysis programs. (Division of Transportation Planning, Planning Support Section, Research Coordination Unit; 23 USC 109 (h) through (j), 42 USC 4331 and 4332)
112. Provides technical assistance to Transportation Research Board (TRB) committees and panels as assigned, and distributes TRB information as required. (Division of Transportation Planning, Planning Support Section, Research Coordination Unit; 23 USC 307 (c) and 315; 49 CFR 1.48 (b))
113. Assists in development of long-range traffic records programs. (Division of Highway Safety, Planning/Research and Evaluation Section; 24-42-103 (2) (a), C.R.S. 1973)
114. Updates and maintains the division's statistical file and collects traffic safety data. (Division of Highway Safety, Planning/Research and Evaluation Section; no state statutory mandate).

Information Generation and Distribution

115. Responds to requests for information from the media on department operations. (Office of Management and Budget, Public Information Section; no state statutory mandate)
116. Edits and distributes bulletins, reports and news releases, and maps for general public use. (Office of Management and Budget, Public Information Section; no state statutory mandate)
117. Presents information relating to highway matters to interested groups. (Office of Management and Budget, Public Information Section; no state statutory mandate)
118. Provides rideshare, transit, and bike information and implements and enforces an ongoing parking management program. (Division of Transportation Planning, Program Development Section, Special Programs Unit; Rideshare Program Regulation Number 9)
119. Prepares and disseminates news releases/newsletters dealing with highway safety. (Division of Highway Safety, Public Information Section; no state statutory mandate).
120. Prepares and disseminates news releases, pamphlets, correspondence and newsletters relating to activities of the state patrol. (Division of State Patrol, Staff Services Section; 43-5-112 (2), C.R.S. 1973)

Map Production

121. Maintains and revises the general highway map series. (Division of Transportation Planning, Planning Support Section, Mapping and Field Operations Unit and Program Development Section; 43-2-120 (5), C.R.S. 1973 and HPPM Volume I, Chapter I, Paragraph 5)
122. Prepares the administrative systems map on an annual basis. (Division of Transportation Planning, Planning Support Section, Mapping and Field Operations Unit and Program Development Section; 43-2-146, C.R.S. 1973)
123. Prepares a tourist map and other special maps and charts on an as-required basis to meet the needs of highway administration and compiles monthly construction information for a construction bulletin. (Division of Transportation Planning, Planning Support Section, Mapping and Field Operations Unit and Program Development Section; no state statutory mandate)

Law Enforcement

124. Reviews traffic control measures used on all classes of streets and highways and reviews municipal and county traffic codes for conformity with state law. (Division of Highways, Staff Traffic and Safety Projects Section; 43-2-135 (1) (g), C.R.S. 1973)
125. Provides preparatory training for all state patrol officers. (Division of State Patrol, Staff and Administration, CLETA Section; 43-5-112 (3), C.R.S., 1973)
126. Promotes safety, protects human life, and preserves the highways of the state by enforcement of the laws and regulations relating to highways and traffic, inspection, registration and regulation of all vehicles and cargoes, the collection of motor vehicle license taxes, motor fuel taxes, and highway compensation taxes. (Division of State Patrol, Field Districts; 43-5-103 (2) (a) and 43-5-113 (2), C.R.S. 1973)
127. Makes arrests for any violation of the laws dealing with the operation of vehicles and use of the highways or concerning motor vehicle registration, the motor fuels tax, public utility laws, rules and regulations related to motor vehicle carriers, vehicle inspection laws, automobile theft law, and auto and tourist camp law. (Division of State Patrol, Field Districts; 43-5-113 (1) (a), C.R.S. 1973)

128. Requires the operator of any vehicle to stop and, upon demand, exhibit his driver's license and vehicle registration card and submit to complete inspection of such vehicle and any equipment within. (Division of State Patrol, Field Districts; 43-5-113 (1) (b), C.R.S. 1973)
129. For the purpose of locating stolen vehicles, inspects any vehicle required to be registered at any place where such vehicles are held for sale or wrecking. (Division of State Patrol, Field Districts; 43-5-113 (1) (c), C.R.S. 1973)
130. Serves warrants, notices, summons, or other processes relating to the enforcement of laws dealing with motor vehicles or the use of the highways or distraint warrants issued by the Public Utilities Commission. (Division of State Patrol, Field Districts; 43-5-113 (1) (d), C.R.S. 1973)
131. Investigates traffic accidents and makes reports to the chief of the patrol, the Department of Highways, and Department of Revenue. (Division of State Patrol, Field Districts; 43-5-113 (1) (e), C.R.S. 1973)
132. Directs, controls, and regulates all traffic at any intersection or any portion of streets or highways when deemed necessary. (Division of State Patrol, Field Districts; 43-5-113 (1) (f), C.R.S. 1973)
133. Stops vehicles carrying livestock, poultry, or carcasses to examine permits, written statements, or livestock inspectors' certificates, and makes arrests for violations involving livestock theft and transportation. (Division of State Patrol, Field Districts and Executive Security Unit; 43-5-113 (1) (h), C.R.S. 1973)
134. Upon authorization of the Governor, enforces all laws of the state with respect to grounds and buildings owned by the state or any agency or institution thereof. (Division of State Patrol, Field Districts and Executive Security Unit; 43-5-113 (1) (i), C.R.S. 1973)
135. Assists any sheriff or other peace officer in the performance of his duties upon request. (Division of State Patrol, Field Districts; 43-5-113 (3), C.R.S. 1973)
136. Enforces all laws of the state during and in connection with the Colorado State Fair and Industrial Exposition. (Division of State Patrol, Field Districts; 43-5-127 (1) and (2), C.R.S. 1973)

Criminal Investigation

137. Supervises a statewide effort to reduce auto theft and increase recoveries. (Division of State Patrol, Field Operations, Auto Theft Unit; no state statutory mandate)
138. Investigates the theft of vehicles. (Division of State Patrol, Auto Theft Unit and Field Districts; 43-5-113 (1) (a), (c) and (g), C.R.S. 1973)
139. Regularly inspects dismantlers, junk yards, body shops, used car dealers and similar businesses for enforcement of daily record laws, storage laws, auto theft and related laws. (Division of State Patrol, Auto Theft Unit and Field Districts; 43-5-113 (1) (a), (c) and (g), C.R.S. 1973)
140. Investigates reported thefts of vehicles and holds discovered stolen vehicles or parts. (Division of State Patrol, Field Districts and Auto Theft Unit; 43-5-113 (1) (g), C.R.S. 1973)

Protection for Governmental Officials

141. Makes available an officer to protect the immediate family of the Governor. (Division of State Patrol, Staff and Administration and Field Operations; 43-5-117, C.R.S. 1973)
142. Provides security for the Governor, his dependents, the Lieutenant Governor, and any governor-elect. (Division of State Patrol, Executive Security Unit and Chief; 43-5-117, C.R.S. 1973)
143. Provides security to the General Assembly while members are in session. (Division of State Patrol, Staff and Administration and Executive Security Unit; no state statutory mandate)
144. Provides security for the Executive Mansion and the State Capitol complex. (Division of State Patrol, Executive Security Unit and Chief; 43-5-113 (1) (i), C.R.S. 1973)

Transportation Planning

145. Conducts A-95 reviews; reviews transportation improvement plans (TIPs); and prepares budgets and objectives for district offices. (Division of Highways, Field Districts; no state statutory mandate)

146. Forecasts revenue to be available to the Department of Highways from federal, state and local sources. (Office of Management and Budget, Fiscal Planning and Budgeting Section; no state statutory mandate)
147. Functions as liaison with the Federal Railroad Administration in rail planning and rail service assistance project matters concerning Colorado, including preparing applications and related documents for the Federal Railroad Administration rail planning and project funding. (Transportation Planning Division, Planning Support Section, Rail Programs Unit; PL94-210, PL95-607, 43-1-801, and 43-1-802, C.R.S. 1973)
148. Develops legislative budget requests for matching funds for federal rail planning and project administration funds, and keeps legislative committees informed of the status of the state rail planning and project activities. (Transportation Planning Division, Planning Support Section, Rail Program Unit; PL94-210, PL95-607; 43-1-801, and 43-1-802, C.R.S. 1973)
149. While collecting, evaluating and compiling data necessary for the development of the State Rail Plan Updates, coordinates rail planning with local government agencies. (Transportation Planning Division, Planning Support Section, Rail Programs Unit; PL94-210, PL95-607; 43-1-801 and 802, C.R.S. 1973)
150. Administers the Federal Rail Service Assistance program projects, including soliciting rail service assistance project applications, selecting projects for funding and formulating detailed benefit cost analyses for proposed rail service assistance projects. (Transportation Planning Division, Planning Support Section, Rail Programs Unit; PL94-210, PL95-607; 43-1-801-802, C.R.S. 1973)
151. Coordinates and monitors the transportation planning process and administers federal planning funds appropriated to Metropolitan Planning Organizations (MPOs) to conduct mandated planning activities. (Transportation Planning Division, Program Development Section, Urbanized Unit; 23 USC 104, 23 USC 134, 23 USC 315; FHPM 4-4-2; and 43-1-105 (1) (i), C.R.S. 1973)
152. Provides administrative, capital and operating grants to private and public operators of public transportation projects in non-urbanized areas of the state. (Transportation Planning Division, Program Development Section, Special Programs Unit; 43-1-701, C.R.S. 1973; 23 USC 315; 49 USC 1601, et seq)

153. Provides capital grants to non-profit organizations to meet the special transportation needs of elderly and handicapped persons. (Transportation Planning Division, Program Development Section, Special Programs Unit; 43-1-601, C.R.S. 1973; PL88-365, 78 Stat., 302; 49 USC 1601 et seq)

Internal Support Services

Administrative Support

154. Prepares and processes agreements for the various divisions within the department. (Division of Highways, Staff Design Section; Department of Highways Memorandum 306, December 1, 1974)
155. Prepares court documents for the department's defense in tort liability cases and updates photolog system. (Division of Highways; Staff Traffic and Safety Projects Section; no state statutory mandate)
156. Provides general administrative support for the department including mail handling, filing, selling department documents to the general public, distributing documents internally, and coordinating the liability claims program. (Division of Administration, Administrative Services Section; no state statutory mandate)
157. Coordinates the development and maintenance of all department policy and procedural directives. (Division of Administration, Administrative Services Section; no state statutory mandate)
158. Maintains a department-wide forms' control program. (Division of Administration, Administrative Services Section; Colorado Fiscal Rules 3.32.01)
159. Conducts all centralized personnel activities for the department. (Division of Administration, Personnel Section; 24-50-101 through 24-50-304, C.R.S. 1973)
160. Functions as the records liaison officer for the department. (Division of Administration, Administrative Services Section; 24-80-103, C.R.S. 1973)
161. Researches the implications of existing or proposed legislation upon the department. (Office of Management and Budget, Management Services Section; no state statutory mandate)

162. Provides technical assistance, training, and direction to department personnel on matters relating to Title VI and Title VII Equal Employment Opportunity/Affirmative Action programs. (Office of Management and Budget, Equal Employment Opportunity Section; Title VI and Title VII of the Civil Rights Act of 1964 and Department of Highways' Policy Directive #600)
163. Interprets federal Civil Rights regulations and develops and monitors programs for compliance within the department. (Office of Management and Budget, Equal Employment Opportunity Section; Title VI and Title VII of the Civil Rights Act of 1964)
164. Reviews all divisions' activities to determine compliance with federal and state statutes and regulations, management instructions, policies and procedures. (Office of Management and Budget, Audit Section; 23 USC 315; OMB Circular A-102, Attachment P; Department of Highway's Policy Directive #4)
165. Designs and constructs graphic products. (Division of Transportation Planning, Impact Evaluation Section, Project Development Unit; National Environmental Policy Act (1969), Environmental Quality Improvement Act of 1970; CEQ Regulations 40 CFR 1500-1508 (1978); DOT Order 5610.1c (1979); FHPM 7-7-2 23 CFR 771 (1980); FHPM 7-7-1 23 CFR 795; Federal Aid Highway Act (1970) 23 USC 109i; National Food Insurance Act 42 USC 4001-4128; DOT Order 5650.2; Clean Water Act of 1977 33 USC 1251-1376; DOT Order 5660.1a; 1956 Highway Act Section 116 (c), 23 USC 128; 1962 Highway Act Section 9, 23 USC 134; National Wilderness Preservation System 16 USC 1131-32; Land and Water Conservation Fund Act 16 USC 460L; FHPM 7-7-5 23 CFR 790; Federal Water Pollution Control Act 1972 33 USC 1357-1376; Safe Drinking Water Act 1974 USC 300; FHPM 6-7-3 and 67-3-1 23 CFR 650; FHPM 6-7-3-2 23 CFR 650; 40 CFR 120, 122-125, 128-131; 40 CFR 133, 135-136, 148, 228; 1978 Surface Transportation Assistance Act, Section 141 (9); 23 USC 109 (n), 152, 217, 315, and 402 (b) (f); 1966 US DOT Act Section 4 (f), 49 USC 1653 (f); 1966 Highway Act Section 18 23 USC 138; 1968 National Trail Systems Act 16 USC 1241-1249; OMB Circular A-95; 73 CRS 43-4-102; 73 CRS 43-1-220))
166. Provides miscellaneous administrative support for the Division of Highway Safety. (Division of Highway Safety, Administrative Support Unit; no state statutory mandate)
167. Assists in preparing the division's annual and multi-year plans. (Division of Highway Safety, Planning/Research and Evaluation Section; 24-42-103 (2) (a), C.R.S 1973)

168. Prepares an annual report for submission by the Highway Commission to the Governor and General Assembly accounting for the efficient discharge of all responsibilities of the Patrol. (Division of State Patrol, Staff and Administration and also Chief; 43-5-112 (4), C.R.S. 1973)
169. Operates a radio broadcasting and teletype system subject to the review and approval of the state communications coordinator. (Division of State Patrol, Chief and Staff and Administration; 43-5-124 (2), C.R.S. 1973)
170. Coordinates headquarters' and staff branches' activities with field management. (Division of State Patrol, Staff and Administration; no state statutory mandate)
171. Sorts, processes, and files most state patrol records; compiles statistical information; reproduces and distributes patrol materials. (Division of State Patrol, Staff Services Section; no state statutory mandate)
172. Processes abandoned vehicles. (Division of State Patrol, Staff Services Section; no state statutory mandate)
173. Evaluates ongoing and new programs; writes grant applications; and tests and evaluates new equipment. (Division of State Patrol, Staff Services Section; no state statutory mandate)
174. Processes and evaluates information related to accidents, energy conservation, the budget, and fleet management. (Division of ~~State~~ Patrol, Staff Services Section; no state statutory mandate)
175. Monitors and ensures fuel usage of department vehicles is reduced by five percent per year. (Transportation Planning Division, Program Development Section, Special Programs Unit; Executive Order D001179)
176. Operates the Denver Communications Center and coordinates communications statewide. (Division of State Patrol, Staff Services Section; 43-5-124 (2), C.R.S. 1973)
177. Provides 24-hour informational and support service to the public and the ~~Governor's~~ security detail. (Division of State Patrol, Staff Services Section; no state statutory mandate)
178. Assists in evaluating management objectives. (Division of State Patrol, Office of Management and Budget; no state statutory mandate)

179. Operates a radio broadcasting and teletype system. (Division of State Patrol, Staff Services Section and also Field Districts; 43-5-124 C.R.S. 1973)
180. Advises on technical matters, assists in the determination and interpretation of policies, and directs compliance by subordinate employees. (Division of State Patrol, Staff Services Section; no state statutory mandate)

Centralized Services

Aircraft

181. Operates and maintains a central aircraft pool for the benefit of all state agencies, the Governor, and the General Assembly. (Division of State Patrol, Aircraft Unit; Executive Order, April 7, 1975)
182. Transports by aircraft prisoners and wards of the state when required. (Division of State Patrol, Aircraft Unit; no state statutory mandate)

ADP

183. Performs the programming, implementation, and maintenance of all data processing systems within the department. (Division of Administration, Management Information Systems Section; ADP Management Manual Volume 1, Section V, page 0301, issued by Division of ADP, Department of Administration)
184. Formulates a current and long range automated data processing plan for the department. (Division of Administration, Management Information Systems Section; ADP Management Manual Volume 1, Section V, page 0400)
185. Prepares requests for proposals for the acquisition of ADP hardware and/or software. (Division of Administration, Management Information Systems Section; ADP Policy Statement #1, ADP Management Manual)

Auditing, Budgeting and Accounting

186. Periodically audits and approves the expenditures of the Colorado State Patrol. (State Highway Commission; 43-5-121, C.R.S. 1973)
187. Conducts all centralized accounting activities for the department. (Division of Administration, Accounting Section, Accounting Unit; Colorado State Fiscal Rules)

188. Prepares interim billings to the Federal Highway Administration and state/local governments and processes final vouchers and closures in accordance with federal guidelines. (Division of Administration, Accounting Section; Federal Aid Unit; 23 USC, FHPM 6-3-1-1 and FHPM 1-4-6)
189. Devises, prescribes and prepares budgetary procedures and forms and assists in the preparation of budgets for the Division of Highways, Division of Administration, Office of Management and Budget. (Office of Management and Budget, Fiscal Planning and Budgeting Section; 43-1-111, 24-1-105 and 24-1-126 (3) (a), C.R.S. 1973)
190. Prepares a maintenance and operations budget and construction budget for submission to the State Highway Commission, Governor, Joint Budget Committee and other legislative committees. (Office of Management and Budget, Fiscal Planning and Budgeting Section and Management Services Section; 43-1-105 (1) (g), 43-1-111, and 24-1-126 (3) (a), C.R.S. 1973)
191. Coordinates the development and submission of the budgets for the Division of the State Patrol, Division of Highway Safety, and Division of Transportation Planning to the Office of State Planning and Budgeting (OSPB) and the Joint Budget Committee (JBC). (Office of Management and Budget, Management Services Section; 24-37-301 and 24-37-403, C.R.S. 1973, and Budget Procedures Manual prepared by OSPB)
192. Provides financial data to the department's managers and State Highway Commission. (Office of Management and Budget, Fiscal Planning and Budgeting Section; no state statutory mandate)
193. Provides input on budgeted funds to the accounting branch's financial management system (FMS). (Office of Management and Budget, Fiscal Planning and Budgeting Section; no state statutory mandate)
194. Performs audits of expenditures on all non-bid type contracts entered into by the department. (Office of Management and Budget, Audit Section; 23 USC 315; 41 CFR 1-3)
195. Coordinates the submission of fiscal notes to the Office of State Planning and Budgeting for all proposed legislation affecting the department. (Office of Management and Budget, Management Services Section; 24-37-301 (1) (f), C.R.S. 1973 and Executive Order D 0001 81, January 8, 1981)

- 196. Evaluates any plans or actions taken to correct conditions reported by audit findings. (Office of Management and Budget, Audit Section; 23 USC 315; 41 CFR 1-3; US DOT Order 4600.9 B, Attachment 11; Department of Highways Policy Directive #4)
- 197. Provides budget and accounting services to the patrol. (Division of State Patrol, Office of Management and Budget; no state statutory mandate)

Building Operations

- 198. Maintains the headquarters physical plant complex for the department. (Division of Administration, Building Operations Section; no state statutory mandate)
- 199. Maintains all patrol buildings and shared facilities statewide. (Division of State Patrol, Supply and Maintenance Section; 43-5-118, C.R.S. 1973)

Motor Vehicles

- 200. Operates a service center for gas, oil, tires, wheel balance, lubrication and wash for state vehicles. (Division of Highways, Field Districts; no state statutory mandate)
- 201. Services and repairs all department vehicles. (Division of Highways, Motor Pool; no state statutory mandate)
- 202. Distributes, repairs, and maintains all highway patrol fleet vehicles. (Division of State Patrol, Supply and Maintenance Section; 43-5-118, C.R.S. 1973)

Procurement

- 203. Conducts all centralized procurement activities for the department. (Division of Administration, Procurement Section, Purchasing Unit; 24-102-301 through 24-102-502, C.R.S. 1973; State of Colorado Procurement Rules)
- 204. Promulgates procedures to be used by field units for procurement activities and monitors compliance with the procedures. (Division of Administration, Procurement Section, Purchasing Unit; no state statutory mandate)
- 205. Procures and warehouses all equipment and supplies issued by the state patrol. (Division of State Patrol, Supply and Maintenance Section; 43-5-118, C.R.S. 1973)

Repairs

206. Services and repairs photographic equipment owned by the state. (Division of State Patrol, Staff Services Section; no state statutory mandate)

Reproduction

207. Provides reproduction services for all divisions of the department. (Division of Highways, Reproduction Section; no state statutory mandate)

Supplies

208. Maintains a centralized warehouse of often purchased items for the department. (Division of Administration, Central Warehouse; no state statutory mandate)
209. Maintains a stock of office supplies for the department headquarters complex. (Division of Administration, Administrative Services Section; no state statutory mandate)
210. Purchases all necessary supplies and equipment for the state patrol. (Division of State Patrol, Chief; 43-5-118, C.R.S. 1973)

Surplus Disposal

211. Coordinates the disposal of department surplus equipment. (Division of Administration, Procurement Section, Purchasing Unit; 24-30-402 (2) (d), C.R.S. 1973)

Management Operations

212. Disposes of state highway property not anticipated to be used for state highway purposes. (State Highway Commission; 43-1-105 (1) (m), C.R.S. 1973)
213. Approves the policies and procedures of the Colorado State Patrol. (State Highway Commission; 43-5-101 and 43-5-103 (1), C.R.S. 1973)
214. Determines the number of days patrol officers serve as peace officers on the grounds of the state fair. (State Highway Commission; 43-5-127, C.R.S. 1973)
215. Serves as chief executive officer of the State Department of Highways. (Office of Executive Director; 24-1-126 (1), 24-1-105, C.R.S. 1973; Specific duties are not ascribed by statute to the Executive Director)

216. Manages departmental functions as assigned by the Executive Director and acts in the absence of the Executive Director. (Office of Deputy Director; Specific duties are not ascribed by statute to the Deputy Director)
217. Serves as chief administrative officer of the Division of Highways and has direct control and management of its functions. (Division of Highways, Chief Engineer; 43-1-106, C.R.S. 1973)
218. Causes the Attorney General of the state to bring suit on behalf of the State Department of Highways. (Division of Highways, Chief Engineer and Division of State Patrol, Office of Management and Budget; 43-1-108, C.R.S. 1973)
219. Manages department-owned property including maintaining an inventory, drafting leases, assigning rental rates, inspecting property, and supervising and maintaining employee housing records. (Division of Highways, Staff Right-of-Way Section; 43-1-205, 43-1-211 and 212, C.R.S. 1973)
220. Insures equal employment opportunity compliance. (Division of Highways, Field Districts; Title VI and VII of the Civil Rights Act of 1964, and 23 USC 140)
221. Develops departmental interdisciplinary groups to perform assignments in management by objectives, results management, programmatic budget interfaces, organizational development, program evaluation, and other management-related task assignments. (Office of Management and Budget, Management Services Section; no state statutory mandate)
222. Advises executive management on civil rights and equal employment opportunity matters. (Office of Management and Budget, Equal Employment Opportunity Section; no state statutory mandate)
223. Serves as the executive head and senior administrative officer of the Colorado State Patrol. (Division of State Patrol, Chief, Field Operations and Staff and Administration; 43-5-105, C.R.S. 1973)
224. Sets forth, with the approval of the Highway Commission, rules and regulations governing all operating procedures of the state patrol. (Division of State Patrol, Chief, Field Operations and Staff and Administration; 43-5-105, C.R.S. 1973)
225. Designates an officer as acting chief at any time the chief is unable to perform his duties. (Division of State Patrol, Chief, Field Operations and Staff and Administration; 43-5-105, C.R.S. 1973)

226. Appoints with approval of the Highway Commission, commissioned and non-commissioned officers to staff and command or supervisory positions and patrolmen. (Division of State Patrol, Chief, Field Operations and Staff and Administration; 43-5-106, C.R.S. 1973)
227. Establishes such divisions as are necessary for adequate patrolling of the highways. (Division of State Patrol, Chief, Field Operations and Staff and Administration; 43-5-112 (1), C.R.S. 1973)
228. Establishes and maintains a division of safety and education to promote highway safety. (Division of State Patrol, Chief, Field Operations and Staff and Administration; 43-5-112 (2), C.R.S. 1973)
229. Establishes a school for the training and education of members of the state patrol, other police agencies, and departments of the state. (Division of State Patrol, Chief, Field Operations and Staff and Administration; 43-5-112 (3), C.R.S. 1973)
230. Administers the functions of the Colorado Law Enforcement Training Academy (CLETA). (Division of State Patrol, Staff and Administration, CLETA Section; 43-5-112 (3), C.R.S. 1973)

Department Totals:

\$404 K-G
 \$2,002 K-C
 \$3,826 K-F
 \$116,841 K-HUTF
 \$7,910 K-Projects
 \$151,740 K-Construction Program

3,763.5 FTE

DEPARTMENT OF HIGHWAYS

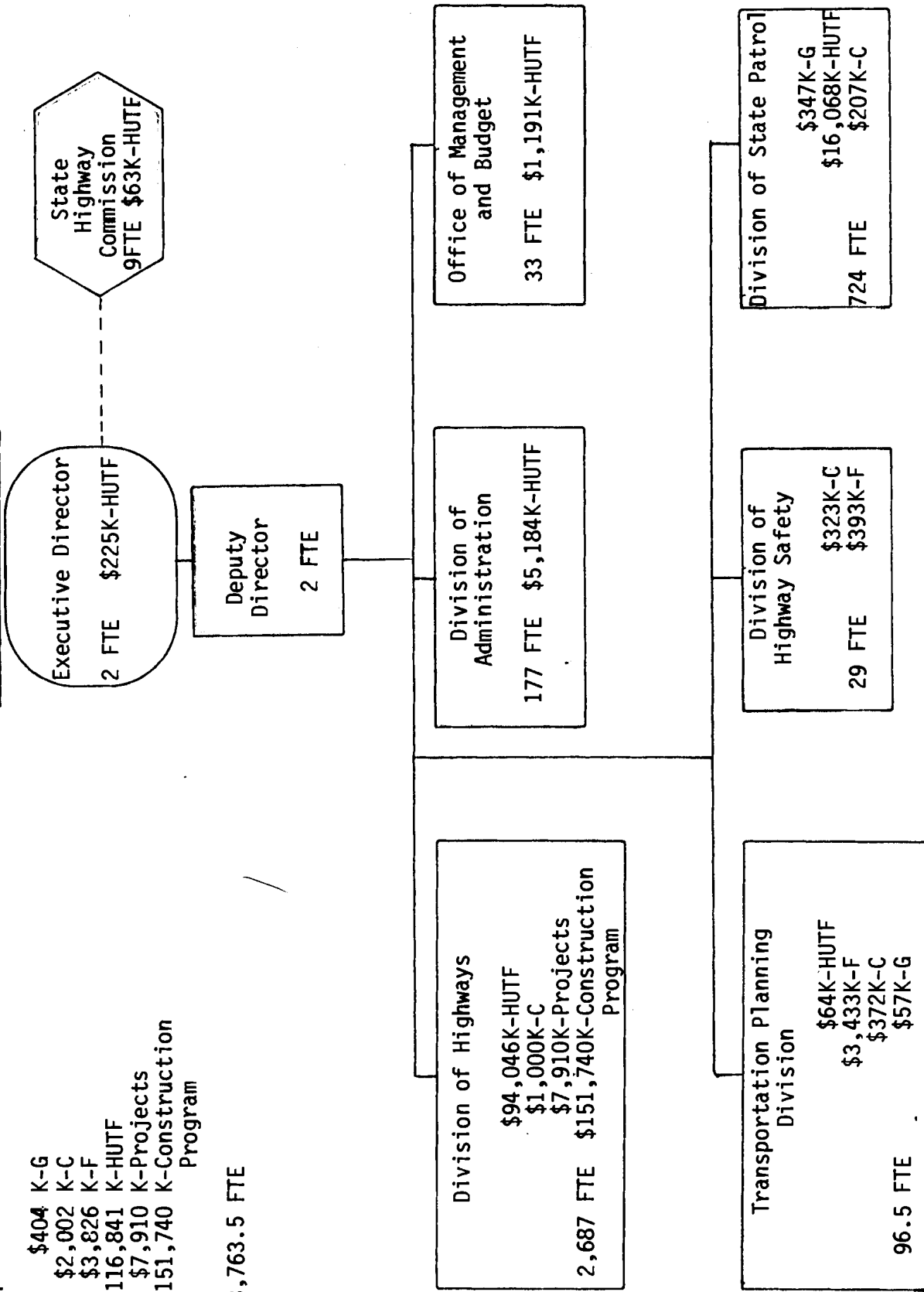

Division Totals:

\$323 K-C
\$393 K-F
29 FTE

DIVISION OF HIGHWAY SAFETY

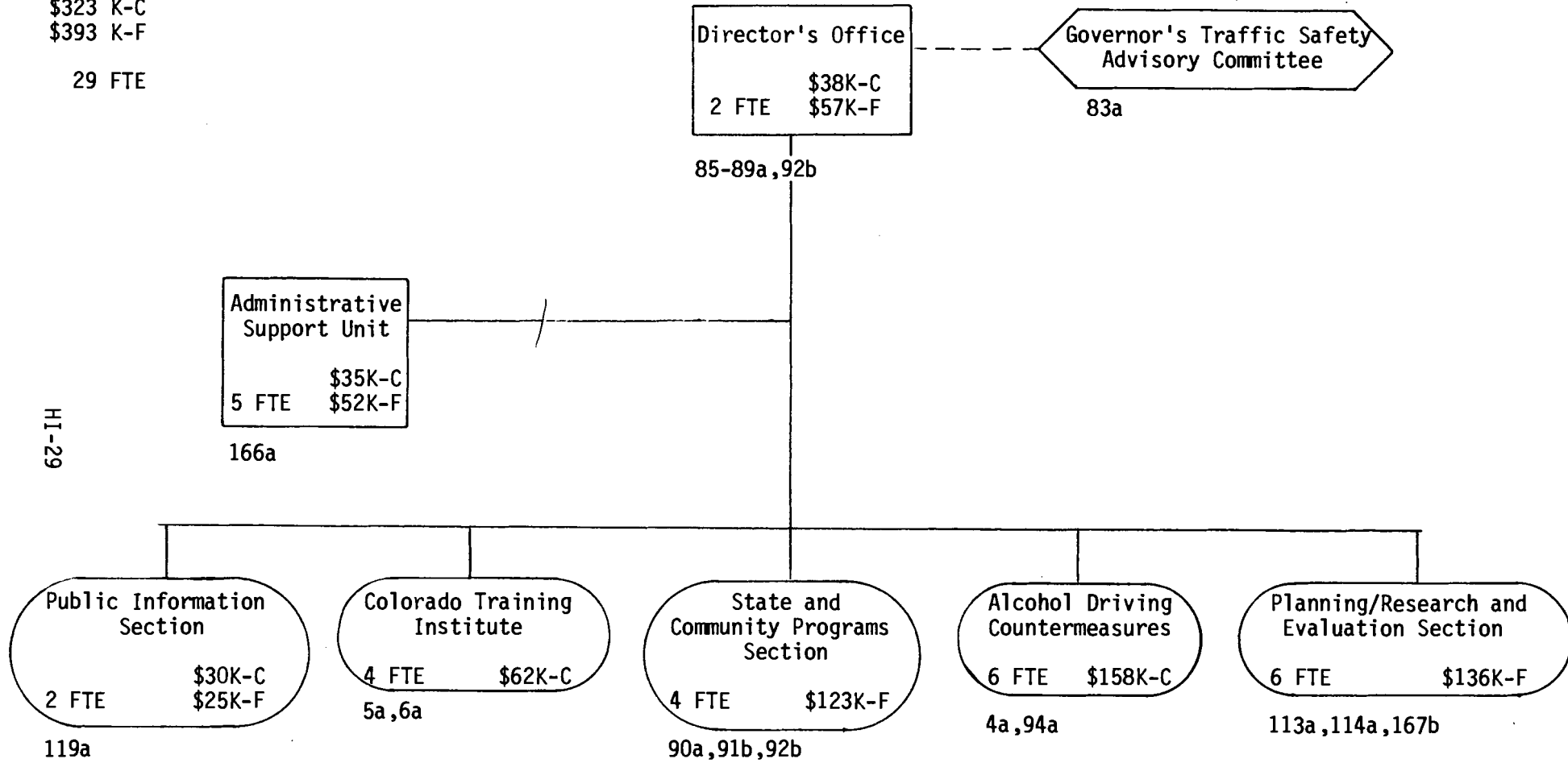

Office Totals:

\$288 K-HUTF

13 FTE

OFFICE OF EXECUTIVE DIRECTOR

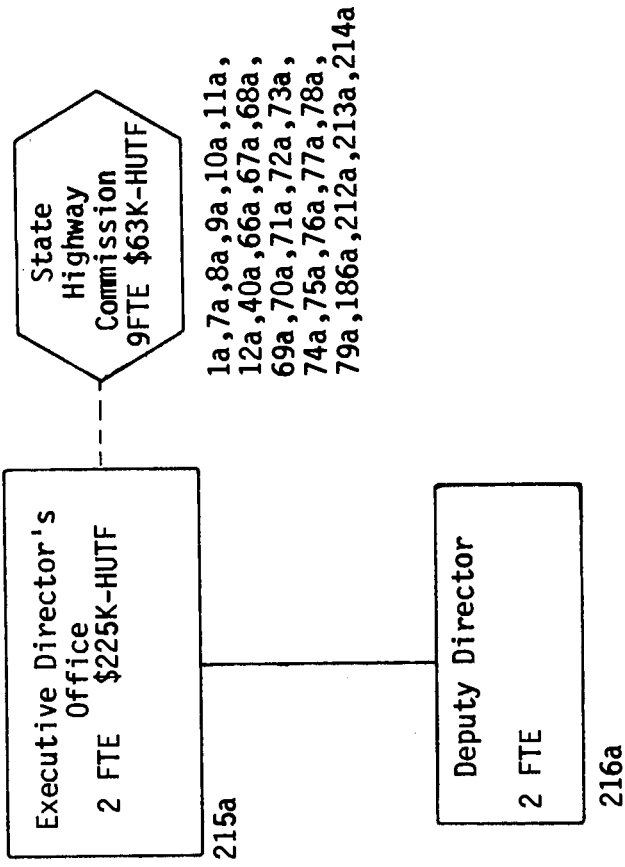

Division Totals:

\$5,184 K-HUTF

177 FTE

DIVISION OF ADMINISTRATION

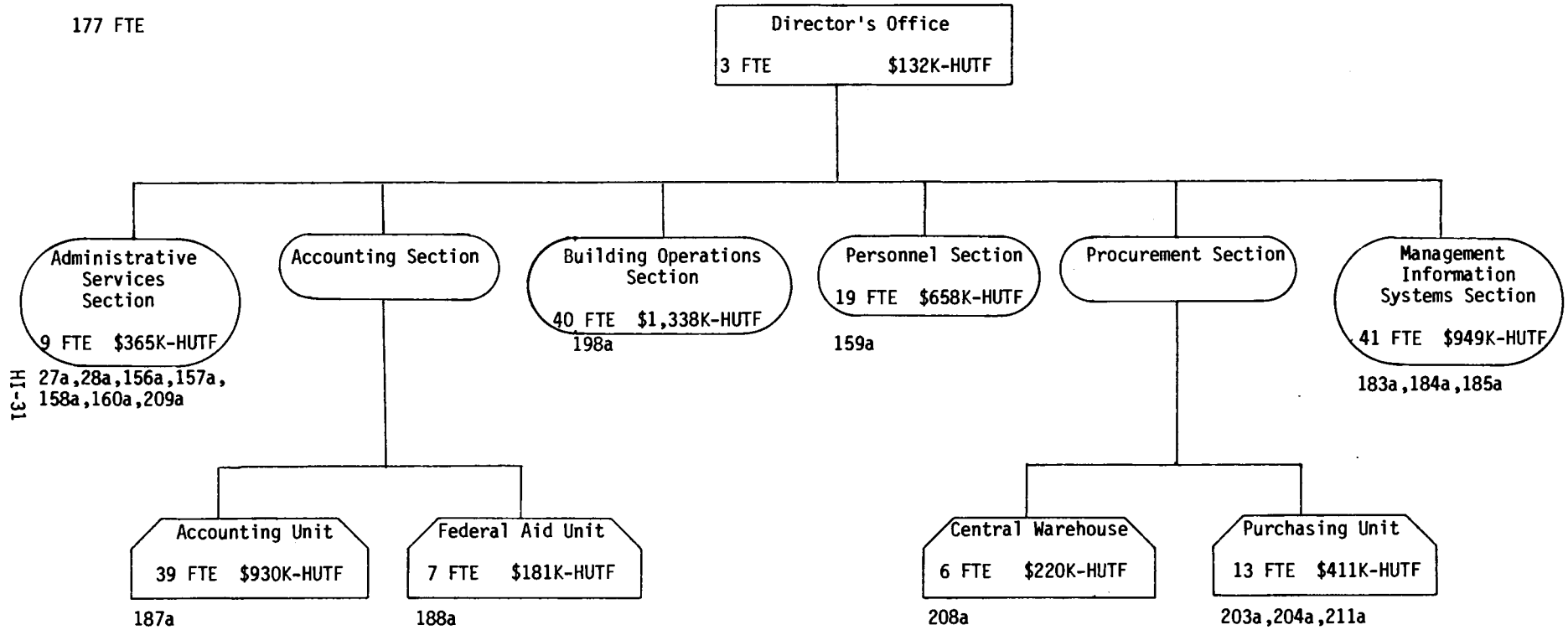

HI-31

Division Totals:
 \$1,000 K-C
 \$94,046 K-HUTF
 \$7,910 K-Projects*
 \$151,740 K-Construction
 Program*

2,687 FTE

DIVISION OF HIGHWAYS

Chief Engineer
 6 FTE \$304K-HUTF

13c,14c,24c,41c,42c,
 44c,45c,46c,201a,217a,218c

HI-32

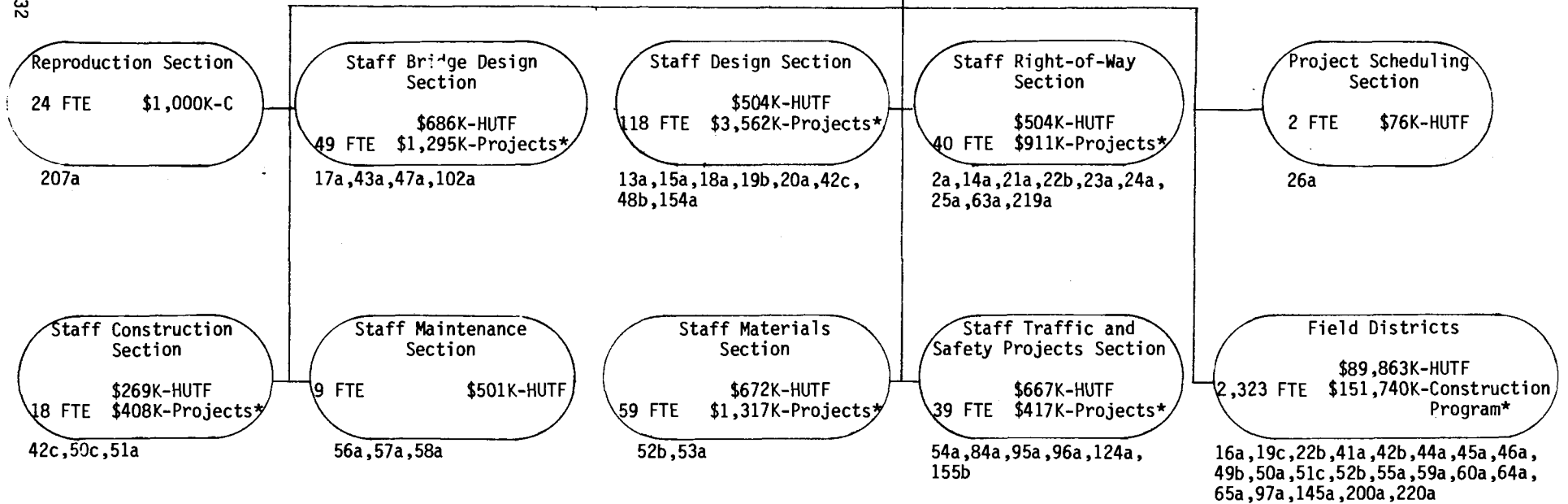

* Project funds and construction programs include federal funds, state matching funds (HUTF) and local matching funds.

Division Totals:

\$1,191 K-HUTF
33 FTE

OFFICE OF MANAGEMENT AND BUDGET

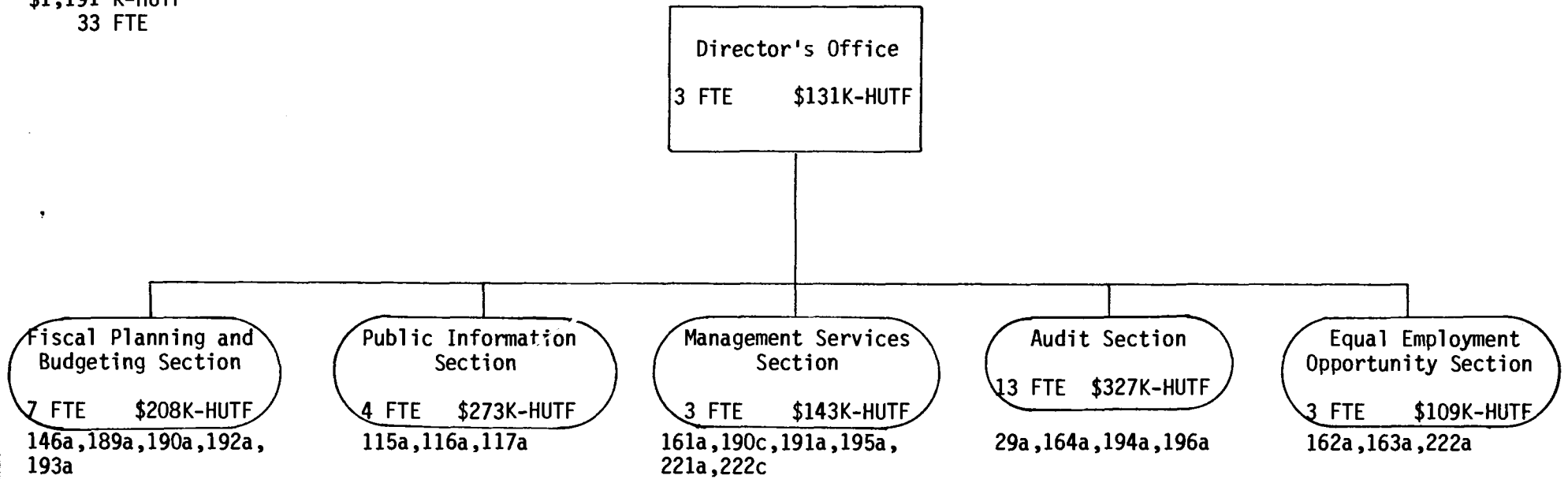

HI-33

Division Totals:

\$347 K-G
\$16,068 K-HUTF
\$207 K-C
724 FTE

DIVISION OF STATE PATROL

Chief
2 FTE \$84K-HUTF

141-144c, 168c, 169b,
210a, 223-229c

Office of
Management
and Budget
8 FTE \$213K-HUTF

178a, 197a, 218a

Staff and
Administration
2 FTE \$62K-HUTF

141b, 143-144b, 168a,
169b, 180c, 223-229b

HI-34

Field Operations
Section
2 FTE \$62K-HUTF

141b, 169c, 223-229b

Staff Services
Section
55 FTE \$194K-HUTF

120a, 130-131c, 168a, 170-
174a, 176-177a, 179b, 180a,
206a

Supply and Maintenance
Section
19 FTE \$601K-HUTF

173c, 199a, 202a, 205a

CLETA Section
13 FTE \$294K-HUTF

125a, 230a

Six Field
Districts
600 FTE \$14,424K-HUTF

93a, 126-136a, 138b, 139b,
140a, 142c, 179a

Auto Theft
5 FTE \$134K-HUTF

129c, 137a, 138b-140b

Executive Security
Unit
13 FTE \$347K-G

133b, 134b, 141c, 142a, 143a,
144a

Aircraft Unit
5 FTE \$207K-C

181a, 182a

Division Totals:

\$64 K-HUTF
 \$3,433 K-F
 \$372 K-C
 \$57 K-G
 96.5 FTE

TRANSPORTATION PLANNING DIVISION

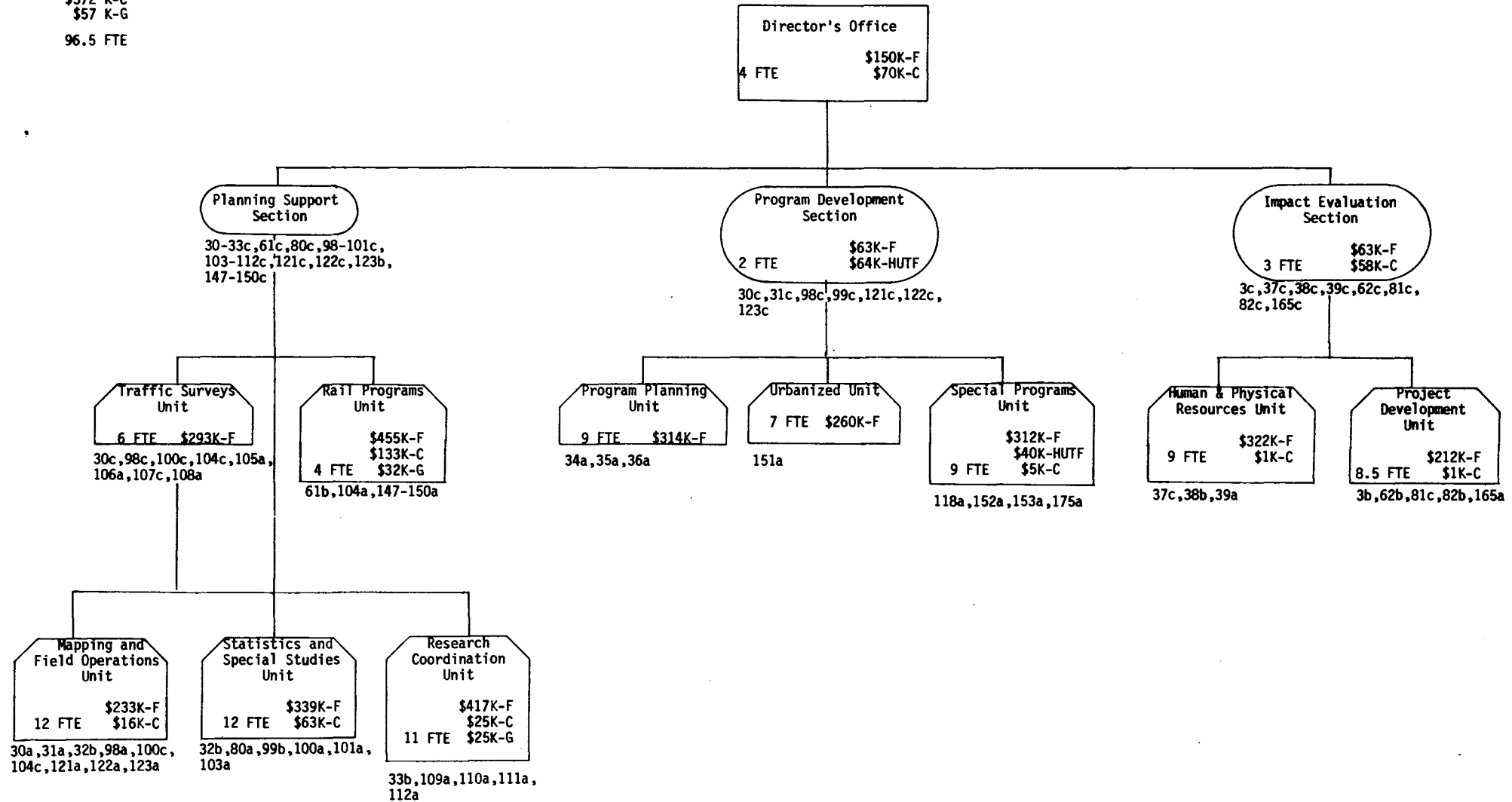

UT 26

DEPARTMENT OF INSTITUTIONS

	<u>Page</u>
<u>Manages the State's Institutional Programs and Facilities</u>	IN-1
<u>Performs Custody and Care Functions for Juveniles</u>	IN-2
<u>Provides Care and Treatment for the Developmentally Disabled</u>	IN-3
<u>Provides Care and Treatment for the Mentally Ill</u>	IN-4

DEPARTMENT OF INSTITUTIONS

Manages the State's Institutional Programs and Facilities

1. Manages, supervises and controls state institutions and agencies for the mentally ill, the developmentally disabled and juvenile delinquents. (Office of Executive Director and directors of all divisions; 27-1-103 (1) (a), C.R.S. 1973)
2. Develops a systematic building program providing for the long-range needs of the institutions within the department. (Office of Executive Director, Program Services and Management Services and all division directors; 27-1-103 (1) (c), C.R.S. 1973)
3. Transfers between appropriate state institutions those children committed to the Department of Institutions. (Office of Executive Director, Deputy Director and all division directors; 27-1-103 (1) (h), C.R.S. 1973)
4. Manages all property, real and personal, used for Department of Institutions purposes. (Office of Executive Director, Deputy Director and Management Services Section; 27-15-104, 27-13-102, 27-14-108, C.R.S. 1973)
5. Supervises all interstate compact agreements for the care and transfer of clients whose legal residence is not in Colorado, or those clients who have absconded, escaped or run away. (Office of Executive Director, Deputy Director and all division directors; 27-10-122, 27-14-106, 24-60-703, C.R.S. 1973)
6. Determines the individual cost of care, support, maintenance, treatment, and education of patients and clients in Department of Institutions facilities. (Office of Executive Director, Management Services and all division directors; 27-12-102 (1), C.R.S. 1973)
7. Assesses against patients or their guardians all or such part of the cost of care as they are able to pay. (Division of Mental Health, Colorado State Hospital and Ft. Logan Mental Health Center and all Community Mental Health Centers, Division of Developmental Disabilities, all regional centers; 27-12-103 (1), C.R.S. 1973)
8. Determines the ability of patients to pay the cost of care. (Office of the Executive Director and all divisional directors; 27-12-104 (2), C.R.S. 1973)
9. Assists in the development of mental health service standards and regulations. (Division of Mental Health, Service Standards Advisory Board; 27-10-129, C.R.S. 1973)

10. Develops and monitors plans and programs for the developmentally disabled. (Office of the Executive Director, State Council on Developmental Disabilities; 27-10.5-201 through 27-10.5-204 and 205, C.R.S. 1973)
11. Manages departmental functions as assigned by the executive director and acts in the absence of the executive director. (Office of the Executive Director, Deputy Director; no statutory mandate)
12. Performs the programming, implementation, and maintenance of all data processing systems within the department. (Executive Director's Office, ADP Services; no statutory mandate)
13. Conducts periodic internal audits and approves expenditures for the department. (Executive Director's Office, Internal Auditor; no statutory mandate)
14. Serves in an advisory capacity to the governor and general assembly on matters affecting the developmentally disabled (Office of the Executive Director, State Council on Developmental Disabilities; 27-10.5-205 (1) (f), C.R.S. 1973)
15. Specifies levels and types of services to be provided through community agencies. (Division of Developmental Disabilities, Director's Office; 27-11-103, C.R.S. 1973)
16. Approves community agencies for the purchase of services. (Division of Developmental Disabilities, Director's Office; 27-11-104, C.R.S. 1973)
17. Consults with the division on matters of concern to mental health. (Division of Mental Health, Mental Health Advisory Council; 27-1-102, C.R.S. 1973)

Performs Custody and Care Functions for Juveniles

18. Grants, defers, suspends or revokes all paroles of children committed to the Department of Institutions. (Division of Youth Services, Juvenile Parole Board; 19-9-103 (2), C.R.S. 1973)
19. Operates facilities necessary for the care, education, training, treatment and rehabilitation of children committed to the custody of the Department of Institutions. (Division of Youth Services, Institutional Services Section; 19-8-101 through 105, C.R.S. 1973.)

20. Provides temporary secure custody to juveniles adjudicated as delinquent, violent or repeat offenders. (Division of Youth Services, Institutional Services Section; 19-3-113 and 114, C.R.S. 1973)
21. Provides detention and shelter services to youths awaiting court disposition. (Division of Youth Services, Detention Services Section; 19-8-117 and 120, C.R.S. 1973).
22. Supervises youths on parole from Department of Institutions' facilities. (Division of Youth Services, Community Services Section; 19-9-102, 105 and 106, C.R.S. 1973)
23. Provides community-based day treatment services as an alternative to formal processing through the juvenile justice system by purchasing services from local diversion programs. (Division of Youth Services, Community Services Section; No state statutory mandate).
24. Establishes districts in the state for the administration of juvenile parole. (Division of Juvenile Parole; 19-9-104 (3), C.R.S. 1973)

Provides Care and Treatment for the Developmentally Disabled

25. Administers a program of purchased community-based developmental disabilities services through community incorporated boards. (Division of Developmental Disabilities, Director's Office; 27-11-102 and 103, C.R.S. 1973)
26. Operates facilities necessary for the care, treatment and training of the developmentally disabled. (Division for Developmental Disabilities, Director's Office and all Regional Centers; 27-14-103, C.R.S. 1973)
27. Secures for the developmentally disabled care and treatment suited to the needs of the individual. (Division for Developmental Disabilities, Regional Centers and Community Centered Boards; 27-10.5-101 through 104, and 113, C.R.S. 1973)
28. Provides short-term and long-term care for the developmentally disabled. (Division for Developmental Disabilities, Regional Centers and Community Centered Boards; 27-10.5-103 and 104, C.R.S. 1973)
29. Provides periodic review of the appropriateness of placement for a developmentally disabled person. (Division for Developmental Disabilities, Regional Centers and Community Centered Boards; 27-10.5-109, C.R.S. 1973)

30. Provides an individualized treatment program for each developmentally disabled resident that includes medical, recreational, training, psychological and social services. (Division for Developmental Disabilities, Regional Centers and Community Centered Boards; 27-10.5-112 through 27-10.5-115, C.R.S. 1973)
31. Enforces regulations for the operation of community-based group homes for the developmentally disabled. (Division for Developmental Disabilities, Director's Office; 27-10.5-133, C.R.S. 1973)

Provides Care and Treatment for the Mentally Ill

32. Operates facilities for inpatient and outpatient treatment for the mentally ill who need institutional services. (Division of Mental Health, Colorado State Hospital and Fort Logan Mental Health Center; 27-13-101 through 113 and 27-15-104, C.R.S. 1973)
33. Secures for the mentally ill care and treatment suited to the needs of the individual. (Division of Mental Health, Fort Logan Mental Health Center, Colorado State Hospital, Community Mental Health Centers; 27-10-116, C.R.S. 1973)
34. Encourages voluntary applications for mental health services. (Division of Mental Health, Community Mental Health Centers and State Hospitals; 27-10-103, C.R.S. 1973)
35. Provides emergency procedure (72-hour) treatment and evaluations. (Division of Mental Health, Fort Logan Mental Health Center, Colorado State Hospital, Community Mental Health Centers; 27-10-105, C.R.S. 1973)
36. Performs court-ordered mental health evaluations. (Division of Mental Health, Fort Logan Mental Health Center and Colorado State Hospital; 27-10-106, C.R.S. 1973)
37. Certifies patients for short-term (three months or less) treatment. (Division of Mental Health, Community Mental Health Centers, Colorado State Hospital and Fort Logan; 27-10-107, C.R.S. 1973)
38. Certifies patients for long-term (six months or less) treatment. (Division of Mental Health, Community Mental Health Centers, Colorado State Hospital and Fort Logan; 27-10-109, C.R.S. 1973)

39. Terminates treatment of certified patients when appropriate. (Division of Mental Health, Community Mental Health Centers, Colorado State Hospital and Fort Logan; 27-10-110, C.R.S. 1973)
40. Maintains individual treatment plans and records of care and treatment which are confidential and privileged. (Division of Mental Health, Community Mental Health Centers, Colorado State Hospital and Fort Logan; 27-10-120, C.R.S. 1973)
41. Administers a program of community-based mental health services purchased from local centers and clinics. (Division of Mental Health, Director's Office; 27-1-203, C.R.S. 1973)
42. Sets standards for approval of community mental health centers and clinics. (Division of Mental Health, Director's Office; 27-1-205, C.R.S. 1973)
43. Provides secure custody, care and treatment for persons adjudged to be not guilty by reason of insanity. (Division of Mental Health, Colorado State Hospital; 16-8-105, C.R.S. 1973)
44. Provides psychiatric examinations ordered by the court in criminal cases. (Division of Mental Health, Colorado State Hospital; 16-8-106, C.R.S. 1973)
45. Provides competency to proceed examinations as ordered by the court in criminal cases. (Division of Mental Health, Colorado State Hospital; 16-8-111, C.R.S. 1973)
46. Receives and treats inmates from the Department of Corrections who are transferred for mental health services. (Division of Mental Health, Colorado State Hospital; 17-23-101, C.R.S. 1973)

Department Totals:

\$94,580K-G
\$ 2,060K-F
\$65,540K-C

3,893 FTE

DEPARTMENT OF INSTITUTIONS

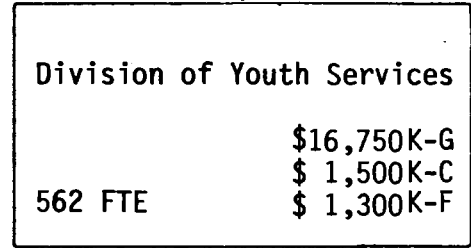
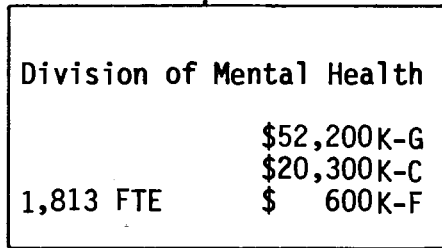
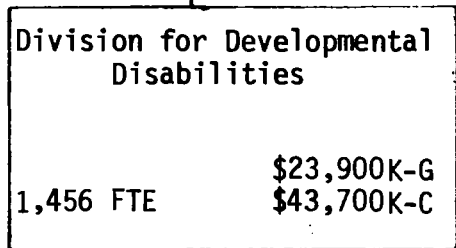
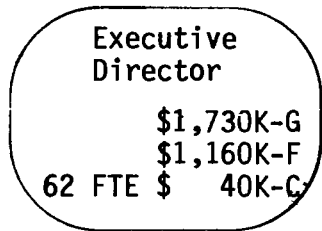

Office Totals:

\$1,730K-G
\$1,160K-F
\$ 40K-C

62 FTE

OFFICE OF THE EXECUTIVE DIRECTOR

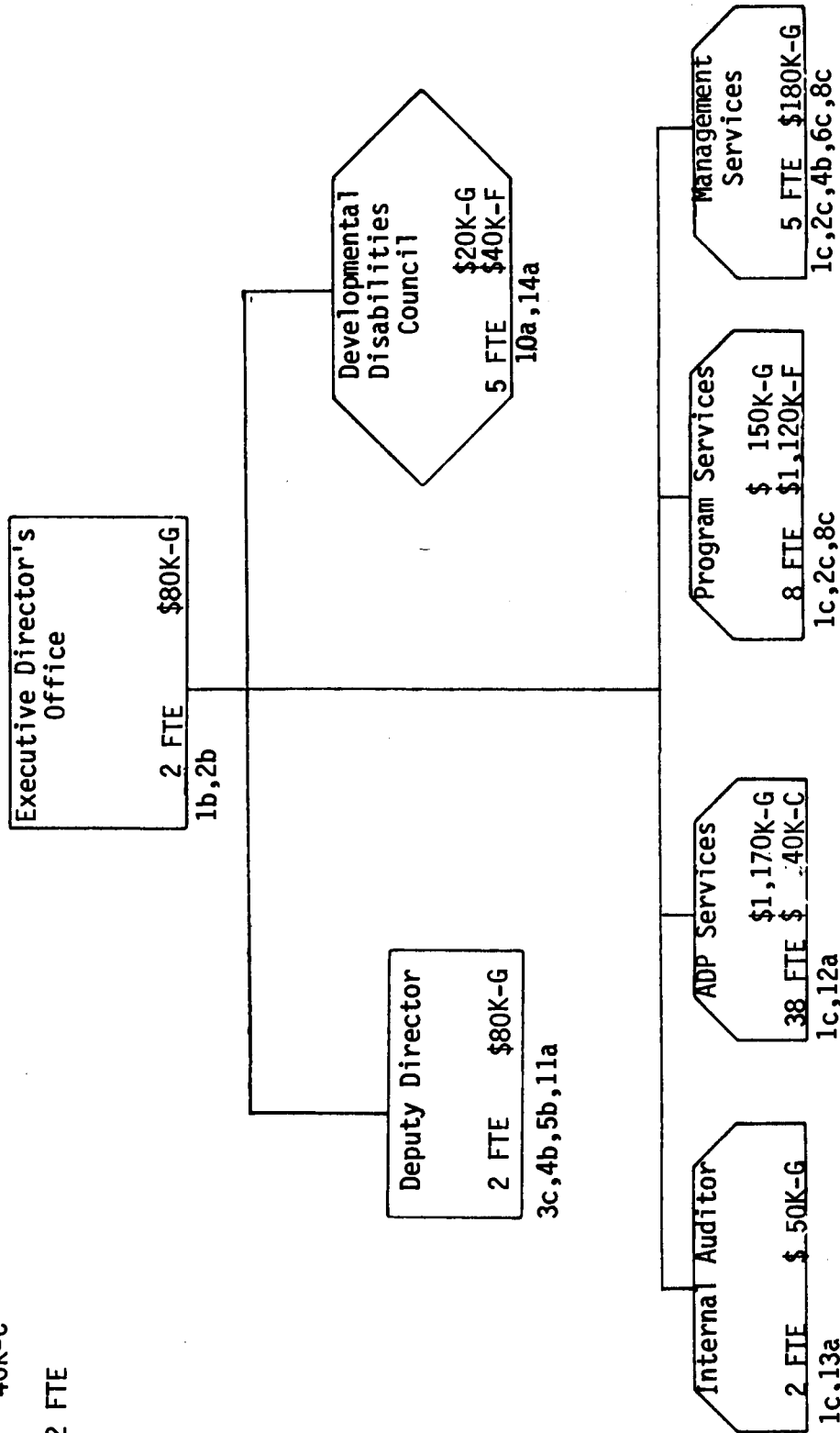

Division Totals:

\$16,750K-G
\$ 1,500K-C
\$ 300K-F

DIVISION OF YOUTH SERVICES

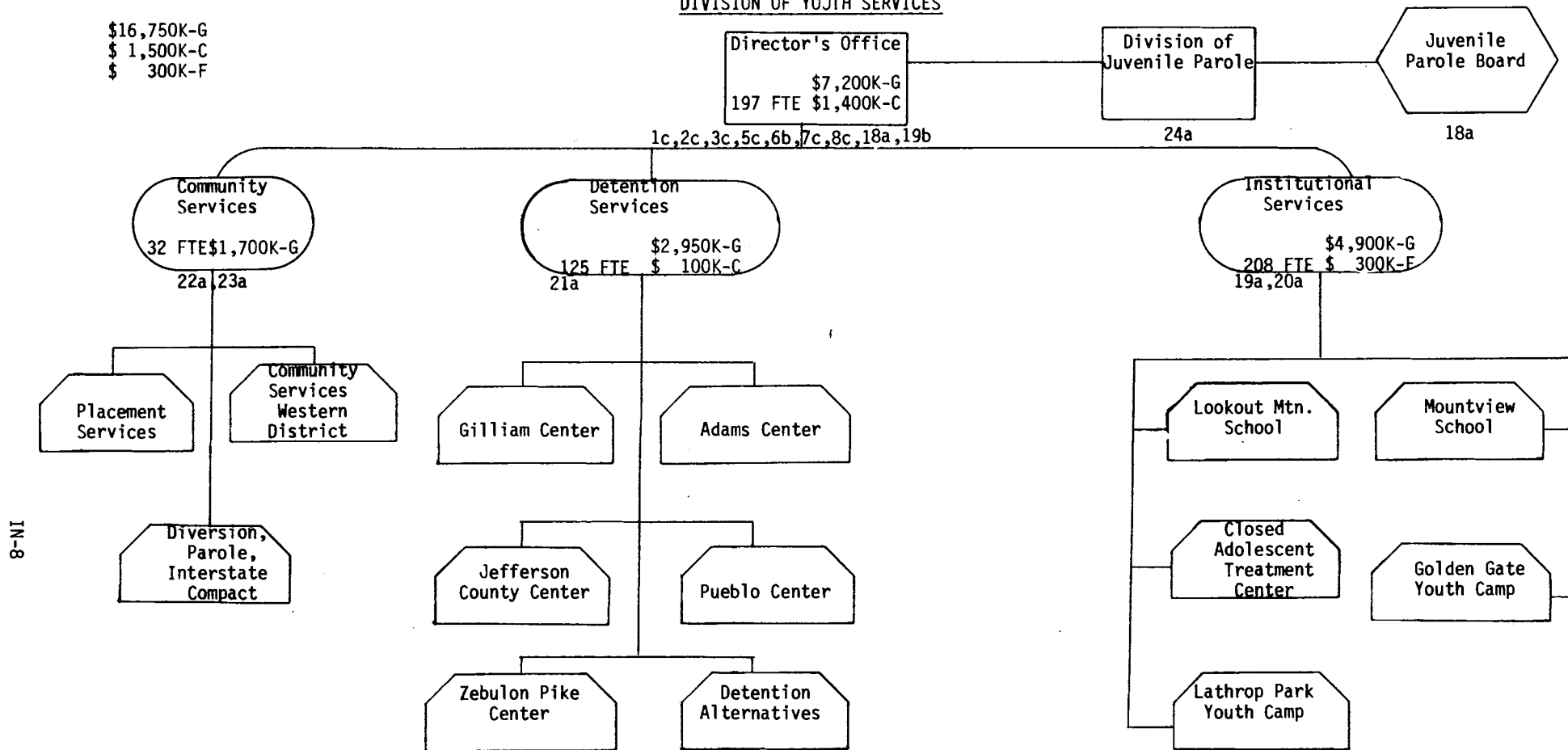

8-INI

Division Totals:

\$23,900K-G

\$13,700K-C

1,456 FTE

DIVISION FOR DEVELOPMENTAL DISABILITIES

Director's Office

24 FTE \$700K-G

1c, 2c, 3c, 5c, 6b, 8c, 115a, 16a, 25a, 26c, 31a

Grand Junction
Regional Center
Superintendent's Office
129 FTE \$ 500K-G
\$3,500K-C

7a, 26a, 27c, 28c, 29c, 30c

Residential/
Training & Therapy
Services
318 FTE \$6,600K-C

27c, 29c

Clinical Services
7 FTE \$300K-C

30c

Pueblo Regional
Center
Superintendent's Office
75 FTE \$ 500K-G
\$4,000K-C

7b, 26a, 27c, 28c, 29c, 30c

Residential/Training
and Therapy Services
223 FTE \$5,100K-C

27c, 29c, 30c

Medical Services
2 FTE \$300K-C

30c

Wheat Ridge
Regional Center
Superintendent's Office
181 FTE \$ 600K-G
\$5,600K-C

7a, 26a, 27b, 28c, 29b, 30c

Residential/
Education & Therapy
Services
482 FTE \$10,100K-C

2 b, 29b, 30b

Medical Services
15 FTE \$500K-C

30b

Community
Contract Agencies
\$21,600K-G
\$ 9,400K-C

7b, 27b, 28c, 29b, 30b

6-NI

Division Totals:

\$52,200K-G
 \$20,300K-C
 \$ 600K-F

1,813 FTE

DIVISION OF MENTAL HEALTH

Director's Office
 25 FTE \$600K-G
 \$500K-F

1c,2c, 3c,5c,6b,8c,
 32b,41a,42a

Service Standards
 Advisory Board

9a

Mental
 Health Advisory
 Board

17a

Colorado
 State Hospital
 Superintendent's
 Office
 154 FTE \$3,400K-G
 \$2,600K-C

7b,32b,33b, 34c,35c,36a,37b,
 38b,39b,40b,43b,44b,45b,46b

Fort Logan
 Mental Health
 Center
 Superintendent's
 Office
 68 FTE \$2,600K-G

7b,32a,33b,34c,35c,36a,
 37c,38c,39c,40b

Community
 Mental
 Health Center's
 Contract Agency

\$16,600K-G
 \$ 4,100K-C

7c,33b,34c,35c,37b,3
 39b,40b

Clinical Services

33c,34c,35c,40b

General Hospital
 and Medical
 Services
 109 FTE \$2,900K-G
 \$1,000K-C

33c

Forensic Psychiatry

307 FTE \$6,550K-G
 \$1,150K-C

43b,44b,45b,46b

Treatment and
 Support Services
 145 FTE \$3,100K-G
 \$ 600K-C

33c

Clinical Services

33c,34c,35c,40b,44b

General Hospitals and
 Medical Services
 17 FTE \$710K-G
 \$230K-C

33c

Drug Treatment
 64 FTE \$1,740K-C

Treatment Support
 Services
 310 FTE \$5,000K-G
 \$2,600K-C

33c

Adult
 103 FTE \$2,620K-G
 \$ 580K-C

Child/Adolescent
 125 FTE \$1,200K-G
 \$2,100K-C

Child/Adolescent
 109 FTE \$1,110K-G
 \$1,890K-C

General Adult
 144 FTE \$3,120K-G
 \$ 680K-C
 \$ 100K-F

Geriatric/
 Aftercare/Deaf
 45 FTE \$1,080K-G
 \$ 320K-C

Geriatric
 83 FTE \$1,690K-G
 \$ 510K-C

Alcohol and Drug
 Abuse Division
 5 FTE \$200K-C

IN-10

DEPARTMENT OF LABOR AND EMPLOYMENT

Page

Facilitates the Delivery of State
and Federally Funded Employment Programs

Automated Data Processing.....	LE-1
Budgeting, Financial Services and Planning.....	LE-1
Employment Search, Training and Placement Services.....	LE-3
Management Operations and Administrative Support Services.....	LE-4
Personnel and Staff Development.....	LE-7
Research and Development.....	LE-8

Provides Unemployment and Workmen's Compensation

Claims Benefits Processing.....	LE-8
Claims Review and Adjudication.....	LE-9
Unemployment Insurance.....	LE-10
Worker's Compensation.....	LE-10

Provides Inspection and Regulation of Facilities and Services

Boiler Inspection.....	LE-11
Oil Inspection.....	LE-12
Private Employment and Theatrical Agencies.....	LE-12
Public Safety.....	LE-12

DEPARTMENT OF LABOR AND EMPLOYMENT

Facilitates the Delivery of State
and Federally Funded Employment Programs

Automated Data Processing

1. Operates the Division of Employment and Training computer and provides related data conversion and data processing and library support to the division and other governmental agencies. (Division of Employment and Training, Information Systems Section, ADP Operations Unit; 8-71-103, C.R.S.)
2. Provides information processing and computerized automation capability for the management and operation of programs and functions of the Division of Employment and Training. (Division of Employment and Training, Information Systems Section; 8-71-103, C.R.S.)
3. Assures the delivery of computer services to various users within the Division of Employment and Training and provides assistance in the design and implementation of on-line and data base applications systems. (Division of Employment and Training, Information Systems Section, ADP Technical Services and Development Unit; 8-71-103, C.R.S.)
4. Provides systems analysis and programming support to the Division of Employment and Training for current systems and establishes and distributes systems and programming standards for all users of the division's computer systems. (Division of Employment and Training, Information Systems Section, ADP Systems Programming Unit; 8-71-103, C.R.S.)
5. Provides development and direction for all ADP services within the Division of Labor and designs new information processing procedures. (Division of Labor, Administrative Services Section, ADP Unit; 8-1-103, C.R.S.)
6. Provides systems analysis, programming support, media control and input-output data control, including data conversion and data processing for the State Compensation Insurance Fund. (State Compensation Insurance Fund, Administrative Services Section, Data Processing Unit; Article 54 of Title 8, C.R.S.)

Budget, Financial Services and Planning

7. Safeguards and accounts for all funds per federal rules and guidelines. (Balance of State/CETA, Fiscal Section;

Comprehensive Employment and Training Act of 1972)

8. Prepares federal reports and is responsible for the reporting and recordkeeping of participants. (Balance of State/CETA, Management Information Systems Section; Comprehensive Employment and Training Act of 1972))
9. Provides and oversees all audits for the U.S. Department of Labor grants. (Balance of State/CETA, Monitoring/Grant Management Section, Audit Unit; Comprehensive Employment and Training Act of 1972))
10. Insures the integrity of the fund and prevents fraud in operations. (State Compensation Insurance Fund, Internal Audit Unit; Article 54 of Title 8, C.R.S.))
11. Administers underwriting, accident prevention, and payroll audit and area offices. (State Compensation Insurance Fund, Policyholders Services Section; Article 54 of Title 8, C.R.S.))
12. Determines the correct premium due from the fund's policyholders by inspection and payroll audit. (State Compensation Insurance Fund, Policyholders Services Section, Payroll Audit Unit; Article 54 of Title 8, C.R.S.))
13. Maintains all fiscal reporting systems; prepares federal reports; and keeps accounts of all funds per established rules and guidelines. (State Compensation Insurance Fund, Administrative Services, Accounting and Controls Unit; Article 54 of Title 8, C.R.S.))
14. Provides fiscal and clerical support for all functions and staff, including preparation of fund availability, allocations to contractors, expense reporting, cash requests and internal budget control. (Office of Manpower Planning and Development, Operations Team; Comprehensive Employment and Training Act of 1972))
15. Develops, executes and controls an automated cost center budget system for the division and insures that fiscal operations meet federal and state fiscal requirements. (Division of Employment and Training, Administration Section, Fiscal Control and Budget Unit; 8-71-103, C.R.S.))
16. Assists the director in routing communication, scheduling and special assignments and coordinates meetings of the State Employment and Training Council. (Office of Manpower Planning and Development, Director's Office; Comprehensive Employment and Training Act of 1972))

Employment Search, Training and Placement Services

17. Monitors compliance with employment service regulations in serving migrant and seasonal farmworkers. (Division of Employment and Training, Director's Office; 20 C.F.R. 653, Subpart B, 1973)
18. Exercises line authority and responsibility in the management, and administration of the activities of three units supporting field operations in the delivery of services to applicants and employers. (Division of Employment and Training, Employment Services; 8-71-103, C.R.S.)
19. Coordinates overall inter-agency services to veterans. (Division of Employment and Training, Veterans Employment Representative; 8-71-101, C.R.S.)
20. Provides employment, manpower and unemployment services to applicants and employers. (Division of Employment and Training, Job Service Centers; 8-71-106, C.R.S.)
21. Monitors the migrant farmworkers program to assure compliance with federal directives and regulations for employment services. (Balance of State/CETA, Director's Office; Comprehensive Employment and Training Act of 1972)
22. Provides technical support for vendor and field staff. (Balance of State/CETA, Field Operations Section, Front Range Operations Unit; Comprehensive Employment and Training Act of 1972)
23. Provides operations and technical assistance to contractors and field staff. (Balance of State/CETA, Field Operations Section, Western Area Operations Unit; Comprehensive Employment and Training Act of 1972)
24. Writes and implements vendor contracts. (Balance of State/CETA, Field Operations Section, Central Operations Unit; Comprehensive Employment and Training Act of 1972)
25. Prepares federal grants for funding and monitors and audits the operation of all functions. (Balance of State/CETA, Monitoring/Grant Management Section; Comprehensive Employment and Training Act of 1972)
26. Investigates and resolves complaints relative to wages, working conditions and youth employment training matters. (Division of Labor, Labor Standards Section, Wage Claims Unit; Title 8, C.R.S.)
27. Registers farm labor contractors, monitors compliance with wage laws and investigates and resolves complaints.

(Division of Labor, Labor Standards Section, Migrant Labor Unit; 8-4-101, C.R.S.)

28. Oversees administration of union security agreement matters, administers prevailing wage laws and assists in the resolution of labor disputes. (Division of Labor, Labor Standards Section, Labor Relations Unit; Articles 1, 3, 16, 17, and 18 of Title 8, C.R.S.)
29. Develops, registers and monitors apprenticeship programs for training in the skilled trades and certifies apprentices. (Division of Labor, Apprenticeship and Training Section; 8-15-102, C.R.S.)

Management Operations and Administrative Support Services

30. Exercises full line authority and responsibility in the management, direction, administration and control of the activities of three units supporting field operations in the delivery of services to applicants and employers under the general supervision of the Chief of Field Operations. (Division of Employment and Training, Field Operations Section, Employment Services Unit; 8-71-103, C.R.S.)
31. Administers an unemployment insurance program according to the Colorado Unemployment Security Act, and directs a supportive staff in those functions necessary for the delivery of services to the employer and claimant. (Division of Employment and Training, Unemployment Insurance Section; 8-73-101, C.R.S.)
32. Provides support services for payroll, accounting, ADP, statistics and the administration of special funds and dependent minor savings accounts. (Division of Labor, Administrative Services Section; 8-1-103, C.R.S.)
33. Engages in long range planning, direction and administration of the Division of Employment and Training. (Division of Employment and Training, Office of the Director; 8-71-101, C.R.S.)
34. Plans, organizes and controls the division's information, advertising and public relations program. (Division of Employment and Training, Director's Office; 8-71-101, C.R.S.)
35. Provides management consulting services to the division to improve performance. (Division of Employment and Training, Director's Office; 8-71-103, C.R.S.)
36. Delivers support and special services. (Division of Employment and Training, Administration Section; 8-71-103, C.R.S.)

C.R.S.)

37. Administers the social security accounts for department personnel under the social security system. (Division of Employment and Training, Public Employees' Social Security Section; 24-7-51, C.R.S.)
38. Manages and maintains buildings in the "employment complex", including housekeeping, groundskeeping, and maintenance of equipment. (Division of Employment and Training, Administration Section, Building and Grounds Unit; 24-30-102, C.R.S.)
39. Plans unemployment insurance operations for the fiscal year; provides unemployment insurance services which assure adherence to established procedures and provides management services to the Unemployment Insurance Section. (Division of Employment and Training, Unemployment Insurance Section, Procedures and Analysis Unit; 8-73-101, C.R.S.)
40. Develops a WIN policy, program planning and direction, monitoring and evaluation, technical assistance, staff development, interadministrative area coordination and inter-agency coordination. (Division of Employment and Training, Field Operations Section, Special Programs (WIN) Unit; 8-71-101, C.R.S., and Federal Social Security Act of 1935)
41. Exercises line authority and responsibility in the management, direction, administration and coordination of the activities of three branches and one unit of the Field Operations Section as well as coordination of the day-to-day activities of field units. (Division of Employment and Training, Field Operations Section, Operations Support Unit; 8-71-106, C.R.S.)
42. Provides operations management and administrative support services to field offices and job service centers. (Division of Employment and Training, Northern Area Manager, Denver Area Manager, and Southern Area Manager; 8-71-103, C.R.S.)
43. Develops and coordinates contracts as well as assisting in the development of recommendations to management. (Division of Employment and Training, Administration Section, Director's Office; 8-71-103, C.R.S.)
44. Manages the activities of local job service centers and satellite offices and coordinates their activities with the information systems, unemployment insurance, administration and research and development sections as well as the division director's office and the federal regional office. (Division of Employment and Training, Field Operations)

Section; 8-71-106, C.R.S.)

45. Designs cost modeling formats and reports; compiles and disseminates unemployment insurance reports; and researches and compiles data for unemployment insurance programs. (Division of Employment and Training, Unemployment Insurance Section, Management Systems Unit; 8-73-101, C.R.S.))
46. Provides guidance for program development and selection programs as well as policy direction for the Division of Employment and Training. (Division of Employment and Training, State Advisory Committee ; 8-72-105, C.R.S.))
47. Distributes all federal documents to the appropriate entities, exercises records management, distributes cost accounting documents and reports, and drafts graphs and statistical charts. (Division of Employment and Training, Administration Section, Communications Services Unit; 8-71-103, C.R.S.))
48. Administers and provides policy for the operation of the Balance of State/CETA. (Balance of State/CETA, Director's Office; Comprehensive Employment and Training Act of 1972)
49. Assists in program operations and is responsible for administrative matters. (Balance of State/CETA, Assistant to the Director; Comprehensive Employment and Training Act of 1972)
50. Provides guidance for all functions of program development and selection and policy direction. (Balance of State/CETA, Colorado Private Industry Council; Comprehensive Employment and Training Act of 1972)
51. Coordinates activities related to the Private Industry Council. (Balance of State/CETA, Private Industry Coordination Section; Comprehensive Employment and Training Act of 1972)
52. Provides the administrative direction of support services for the entire Division of Labor including policy formulation, planning, budget development, legislative liaison support, and personnel liaison support. (Division of Labor, Office of the Director; 8-1-103, C.R.S.))
53. Monitors western slope claims to assure delivery of benefits and resolves controverted claims through administrative hearings. (Division of Labor, Workmen's Compensation Adjudication Section, Grand Junction Office; Articles 40-54 and Articles 65 and 66 of Title 8, C.R.S.))
54. Prepares and modifies U.S. Department of Labor grants.

(Balance of State/CETA, Monitoring/Grant Management Section, Planners Unit; Comprehensive Employment and Training Act of 1972)

55. Underwrites workmen's compensation insurance provided by the State Compensation Insurance Fund, issues the policies and coordinates business relations with policyholders, including the collection of premiums. (State Compensation Insurance Fund, Policyholders Services Section, Underwriting; Article 54 of Title 8, C.R.S.)
56. Supervises functions and staff of the CETA governor's special grant unit under direction of the executive director of the Department of Labor and Employment. (Office of Manpower Planning and Development, Director's Office; Comprehensive Employment and Training Act of 1972)
57. Develops policy recommendations for the department and governor; promotes coordination of economic development activities with employment and training programs at state and local levels and manages economic development contracts including: Jobs for Coloradans Policy Development; Colorado FIRST; energy impact relationships in re employment/education; and local county based economic development experiments. (Office of Manpower Planning and Development, Economic Development Team; Comprehensive Employment and Training Act of 1972)
58. Develops policy recommendations for intergovernment cooperation and manages programs and contracts which promote coordination, including: CETA Vocational Education Coordination Grant; Youth Policy; Corrections Consortium; Department of Institutions Employment Initiatives. (Office of Manpower Planning and Development, Coordination Services Team; Comprehensive Employment and Training Act of 1972)
59. Assumes responsibility for personnel management; assists in the budget and planning process; performs in-house reviews of contracts in the drafting process; and represents the director as needed. (Office of Manpower Planning and Development, Deputy Director; Comprehensive Employment and Training Act of 1972)

Personnel and Staff Development

60. Provides management consulting services to the Division of Employment and Training to improve managerial, administrative and production performances. (Division of Employment and Training, Director's Office; 8-71-103, C.R.S.)
61. Develops and implements an equal employment opportunity and

affirmative action program for the Division of Employment and Training. (Division of Employment and Training, Director's Office; Civil Rights Act, Titles VI and VII 1964; Equal Pay Act 1963; Age Discrimination Act 1967 and 1973; Rehabilitation Act, Sections 503-504, 1973)

62. Plans, develops and administers an agency training and staff development program. (Division of Employment and Training, Staff Development Unit; 8-71-103, C.R.S.)
63. Provides personnel management and staff development; maintains records and produces reports as needed for the State Department of Personnel. (State Compensation Insurance Fund, Administrative Services Section, Personnel Unit; Article 54 of Title 8, C.R.S.)

Research and Development

64. Provides statistical expertise, and produces data involving employment and training, unemployment and economic development programs for state, federal and local agencies and officials. (Division of Employment and Training, Field Operations Section, Research and Development; 8-71-103, C.R.S.)
65. Compiles and prepares all statistical data for Division of Labor reports. (Division of Labor, Administrative Services Section, Statistics Unit; 8-1-103, C.R.S.)
66. Provides the National Council on Compensation Insurance with actuarial information used to formulate insurance rates for work classification codes; and processes first accident reports and claims warrants and determines proper procedures for handling data processing error messages. (State Compensation Insurance Fund, Statistics and Quality Control Unit; Article 54 of Title 8, C.R.S.)

Provides Unemployment and Workmen's Compensation

Claims Benefits Processing

67. Processes unemployment insurance claims in accordance with the Colorado Employment Security Act and determines monetary eligibility of all inter-state and intra-state initial claims filed by claimants. (Division of Employment and Training, Unemployment Insurance Section, Benefits Unit; 8-74-101, C.R.S.)
68. Processes all workmen's compensation claims. (Division of Labor, Workmen's Compensation Claims Section, Claims

Processing; Articles 40 to 54 and Articles 65 and 66 of Title 8, C.R.S.)

69. Administers delivery of medical benefits to qualifying claimants. (Division of Labor, Workmen's Compensation Claims Section, Major Medical Unit); Articles 40 to 54 and Articles 65 and 66 of Title 8, C.R.S.)
70. Maintains records and files for claims adjusting units. (State Compensation Insurance Fund, Benefits Section, Claims Records Unit; Article 54 of Title 8, C.R.S.)

Claims Review and Adjudication

71. Coordinates the activities of referees and staff of the appeals branch in processing and resolving claimant or employer appeals concerning decisions awarding or denying unemployment insurance benefits. (Division of Employment and Training, Unemployment Insurance Section, Appeals Unit; 8-74-103, C.R.S.)
72. Adjudicates appellate cases under the Colorado Workmen's Compensation Act, the Colorado Employment Security Act and the Colorado Labor Peace Act; promulgates rules under the acts; administers the self-insurance program under the Workmen's Compensation Act and adopts classifications and rates for premiums for the State Compensation Insurance Fund. (Industrial Commission; 8-1-102, C.R.S.)
73. Monitors claims to assure delivery of benefits as provided in the Workmen's Compensation Act. (Division of Labor, Workmen's Compensation Claims Section; Articles 40 to 54 and Articles 65 and 66 of Title 8, C.R.S.)
74. Administers the resolution of controverted claims through one or more administrative hearings. (Division of Labor, Workmen's Compensation Adjudication Section; Articles 40 to 54 and Articles 65 and 66 of Title 8, C.R.S.)
75. Examines the work of those involved in handling claims to insure compliance with statutes and the policies of the compensation insurance fund. (State Compensation Insurance Fund, Claims Review Unit; Article 54 of Title 8, C.R.S.)
76. Determines liability and payment of compensation and medical benefits. (State Compensation Insurance Fund, Benefits Section, Claims Unit; Article 54 of Title 8, C.R.S.)
77. Provides legal services to the compensation insurance fund and its policyholders and defends all workmen's compensation cases brought against the fund's policyholders

before the Division of Labor and all civil courts. (State Compensation Insurance Fund, Legal Section; Article 54 of Title 8, C.R.S.)

78. Investigates cases where there is a question of **compensability**. (State Compensation Insurance Fund, Legal Section, Investigation Unit; Article 5 of Title 8, C.R.S.)

Unemployment Insurance

79. **Administers an unemployment insurance program according** to the Colorado Unemployment Security Act and directs a supportive staff in those functions necessary to assure delivery of services to the employer and claimant. (Division of Employment and Training, Unemployment Insurance Section; 8-73-101, C.R.S.)
80. Applies the provisions of the Colorado Employment Security Act in the determination process of employer liability; receives, edits and processes employer contributions reports and collects delinquent reports and monies. (Division of Employment and Training, Unemployment Insurance Section, Tax Unit; 8-74-102, C.R.S.)

Worker's Compensation

81. Assumes responsibility for supervision, coordination and administration of the compensation insurance fund. (State Compensation Insurance Fund, Manager's Office; Article 54 of Title 8, C.R.S.)
82. Makes recommendations to the governor, the general assembly, the executive director, the industrial commission and the manager of the compensation insurance fund to improve efficiency in operation and suggest changes to existing laws. (State Compensation Insurance Fund, Policyholders Advisory Council; 8-54-103, C.R.S.)
83. Insures the integrity of the compensation insurance fund and prevents fraud in operations. (State Compensation Insurance Fund, Internal Audit Unit; Article 54 of Title 8, C.R.S.)
84. Examines the work of those involved in handling claims to insure compliance with pertinent statutes and the policies of the compensation insurance fund. (State Compensation Insurance Fund, Claims Review Unit; Article 54 of Title 8, C.R.S.)
85. Examines open claims and establishes case reserves for reporting to the compensation insurance fund's actuary.

(State Compensation Insurance Fund, Claims Reserving Unit; Article 54 of Title 8, C.R.S.)

86. Administers claims, vocational rehabilitation and claims records. (State Compensation Insurance Fund, Benefits Section; Article 54 of Title 8, C.R.S.)
87. Determines liability and payment of compensation and medical benefits. (State Compensation Insurance Fund, Benefits Section, Claims Unit; Article 54 of Title 8, C.R.S.)
88. Coordinates claims adjusters and vocational rehabilitation vendors for delivery of vocational rehabilitation services. (State Compensation Insurance Fund, Benefits Section, Vocational Rehabilitation Unit; article 54 of Title 8, C.R.S.)
89. Maintains records and files for claims adjusting units. (State Compensation Insurance Fund, Benefits Section, Claims Records Unit; Article 54 of Title 8, C.R.S.)
90. Administers underwriting, accident prevention, payroll audit and area offices. (State Compensation Insurance Fund, Policyholders Services Section; Article 54 of Title 8, C.R.S. 1973)
91. Underwrites workmen's compensation insurance provided by the compensation insurance fund, issues the policies and coordinates business relations with policyholders including collection of premiums. (State Compensation Insurance Fund, Policyholders Services Section, Underwriting Unit; Article 54 of Title 8, C.R.S.)
92. Reduces, through inspection, education, and the like, the risk of accidents to policyholders of the fund and assists policyholders in setting up cost effective accident prevention programs. (State Compensation Insurance Fund, Policyholders Services Section, Accident Prevention Unit; Article 54 of Title 8, C.R.S.)
93. Provides workmen's compensation insurance services to the outlying areas of Colorado. (State Compensation Insurance Fund, Policyholders Services Section, Area Offices Unit; Article 54 of Title 8, C.R.S.)

Provides Inspection and Regulation of Facilities and Services

Boiler Inspection

94. Administers the public safety and boiler. inspection

programs. (Division of Labor, Public Safety Section; 9-4-101 and 9-7-101, C.R.S.)

95. Performs annual inspection and certification of covered boilers and pressure vessels in the state. (Division of Labor, Public Safety Section; 9-4-101, C.R.S.)

Oil Inspection

96. Performs inspections of fuel products at service stations, pipeline terminals, bulk storage plants and transportation facilities as well as examining all antifreeze, brake fluid, lubricants, additives and improvers of products. (Division of Labor, Oil Inspection Section; 8-20-101, C.R.S.)

Private Employment and Theatrical Agencies

97. Regulates (through licensing) and investigates complaints against individuals and companies who operate in the employment and theatrical agency industry. (Division of Labor, Labor Standards Section, Employment and Theatrical Agencies; 12-24-201, C.R.S.)

Public Safety

98. Reviews and approves or rejects plans for school building construction; performs final occupancy inspections; issues explosive permits, and administers regulations pertaining to carnivals and amusement parks. (Division of Labor, Public Safety Section; 9-7-101, C.R.S.)

DEPARTMENT OF LABOR AND EMPLOYMENT

Department Totals:

\$39,116 K-F
7,414 K-C
2,513 K-G
1379.8 FTE

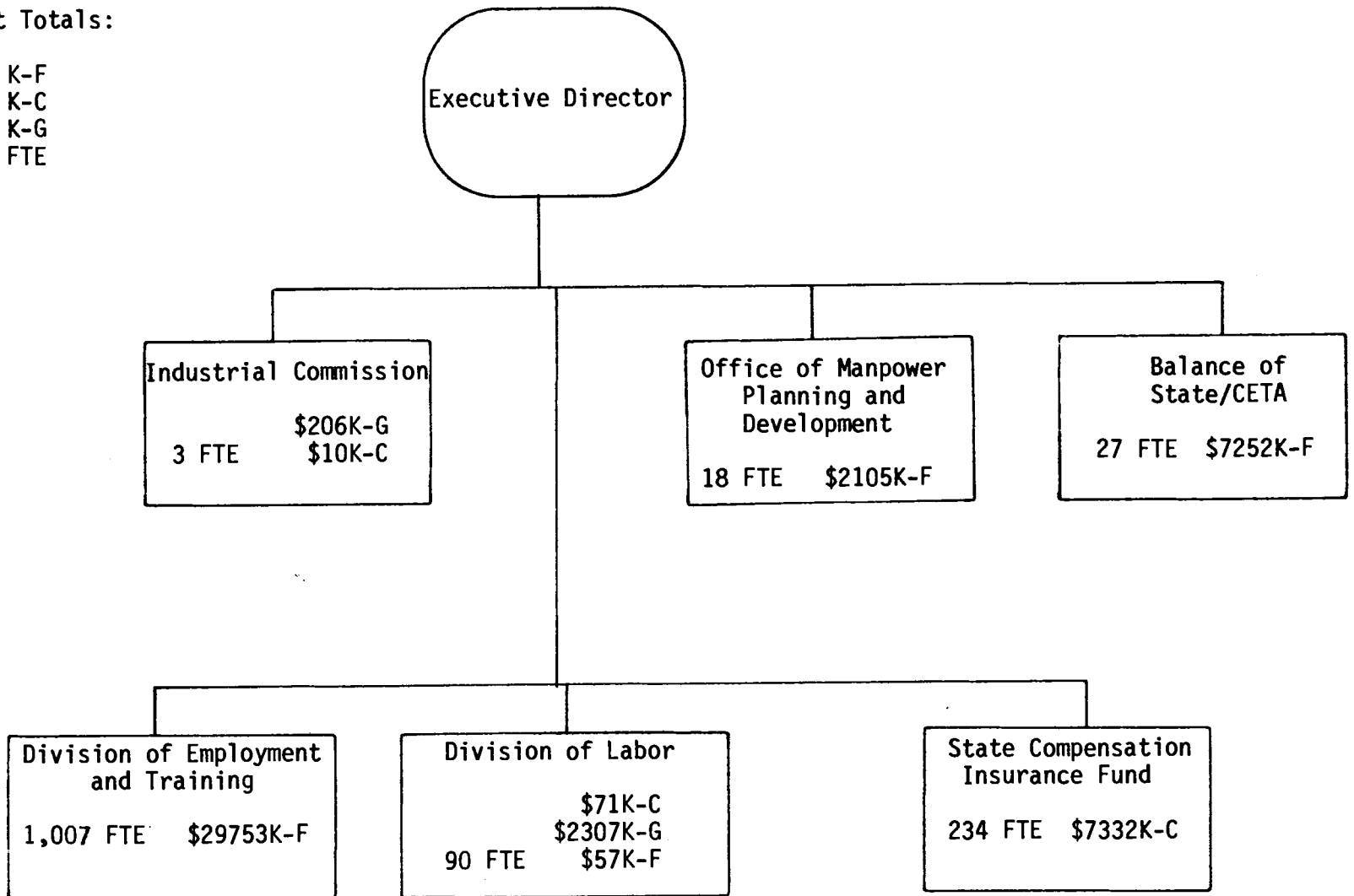

LE-13

DIVISION OF LABOR

Division Totals:

\$72 K-C
 \$2,307 K-G
 57 K-F
 90 FTE

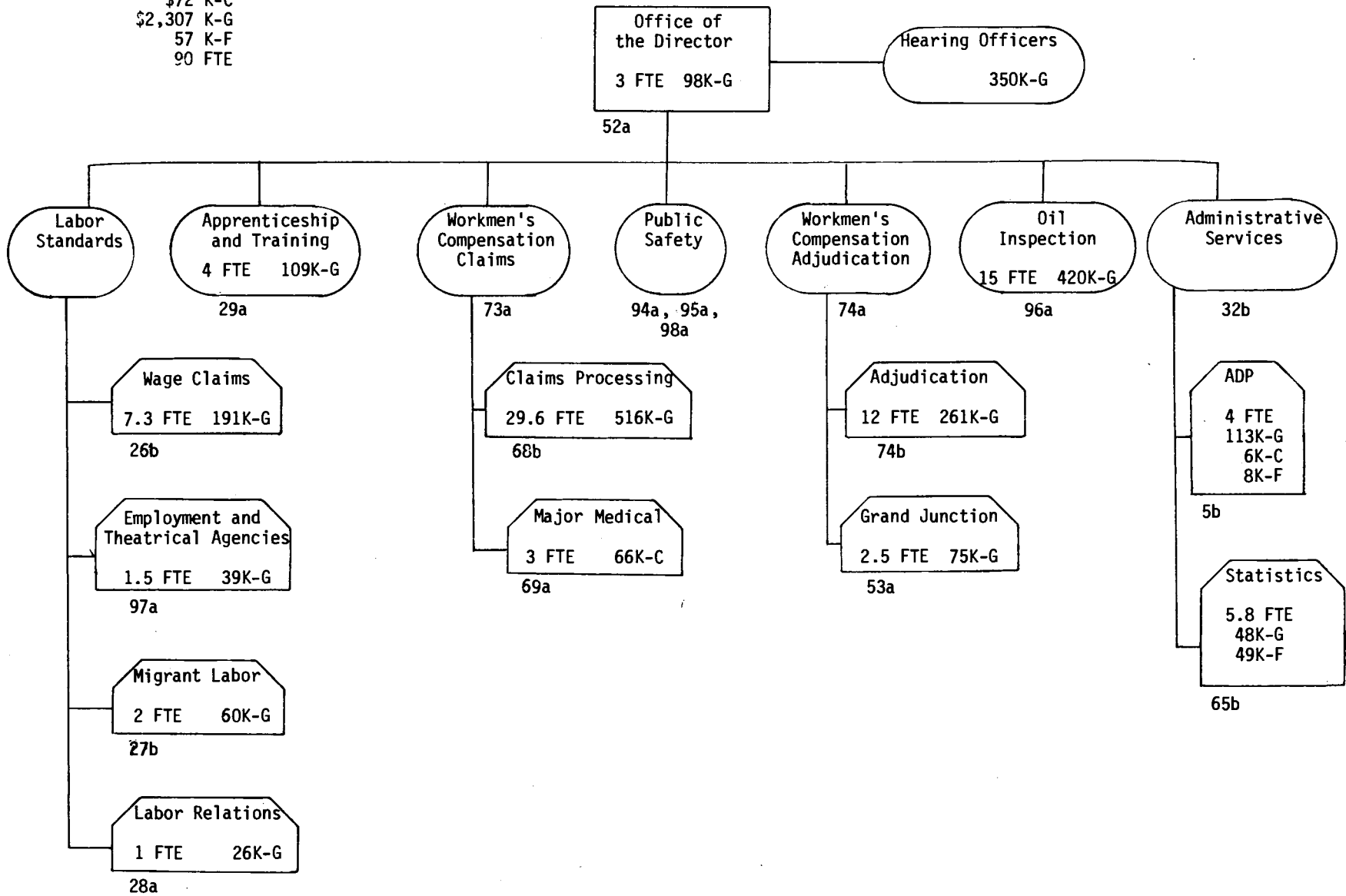

LE-14

\$29,753 K-F
1,007 FTE

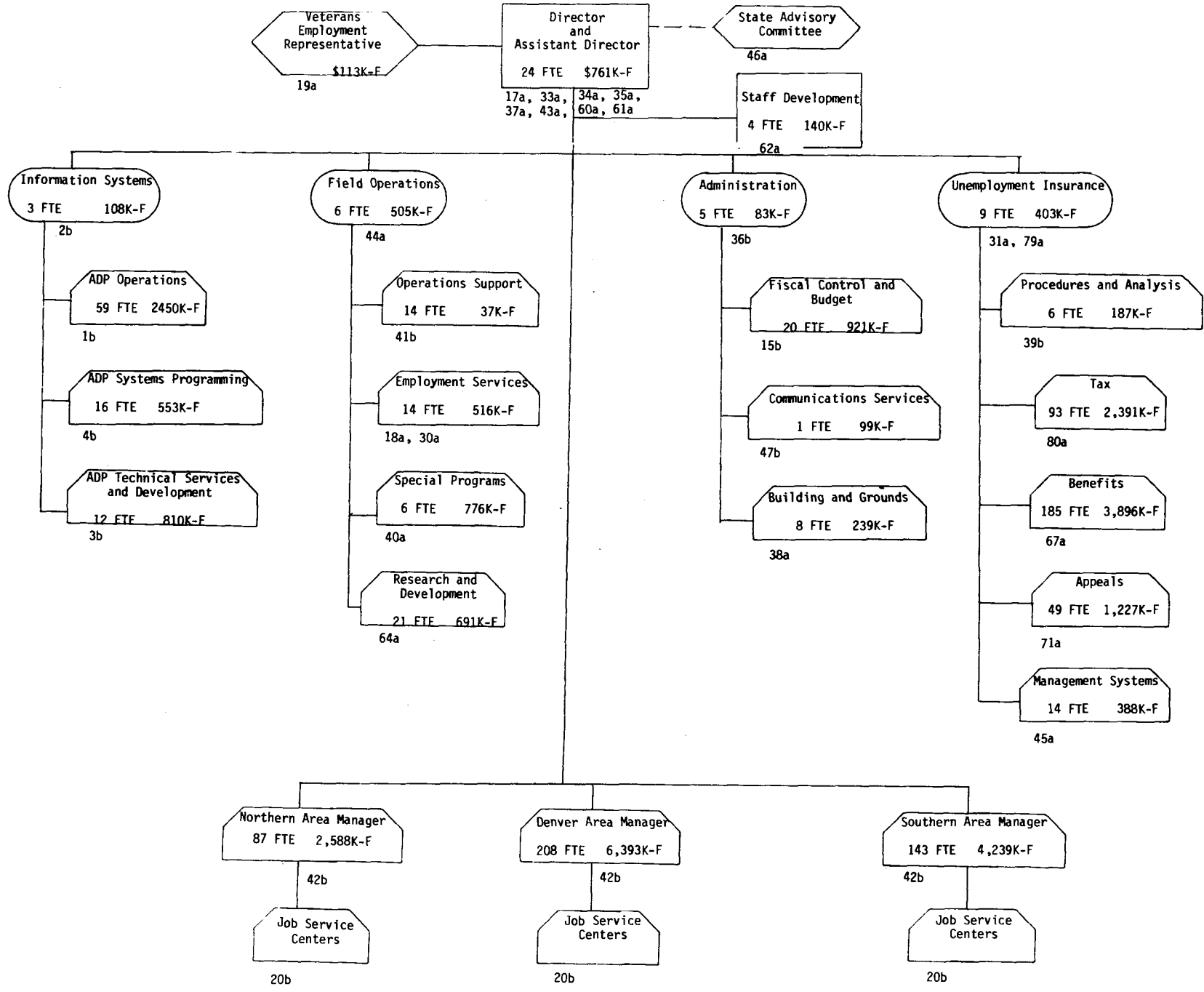

LE-15

BALANCE OF STATE/CETA

Total:

\$7,252 K-F
27 FTE

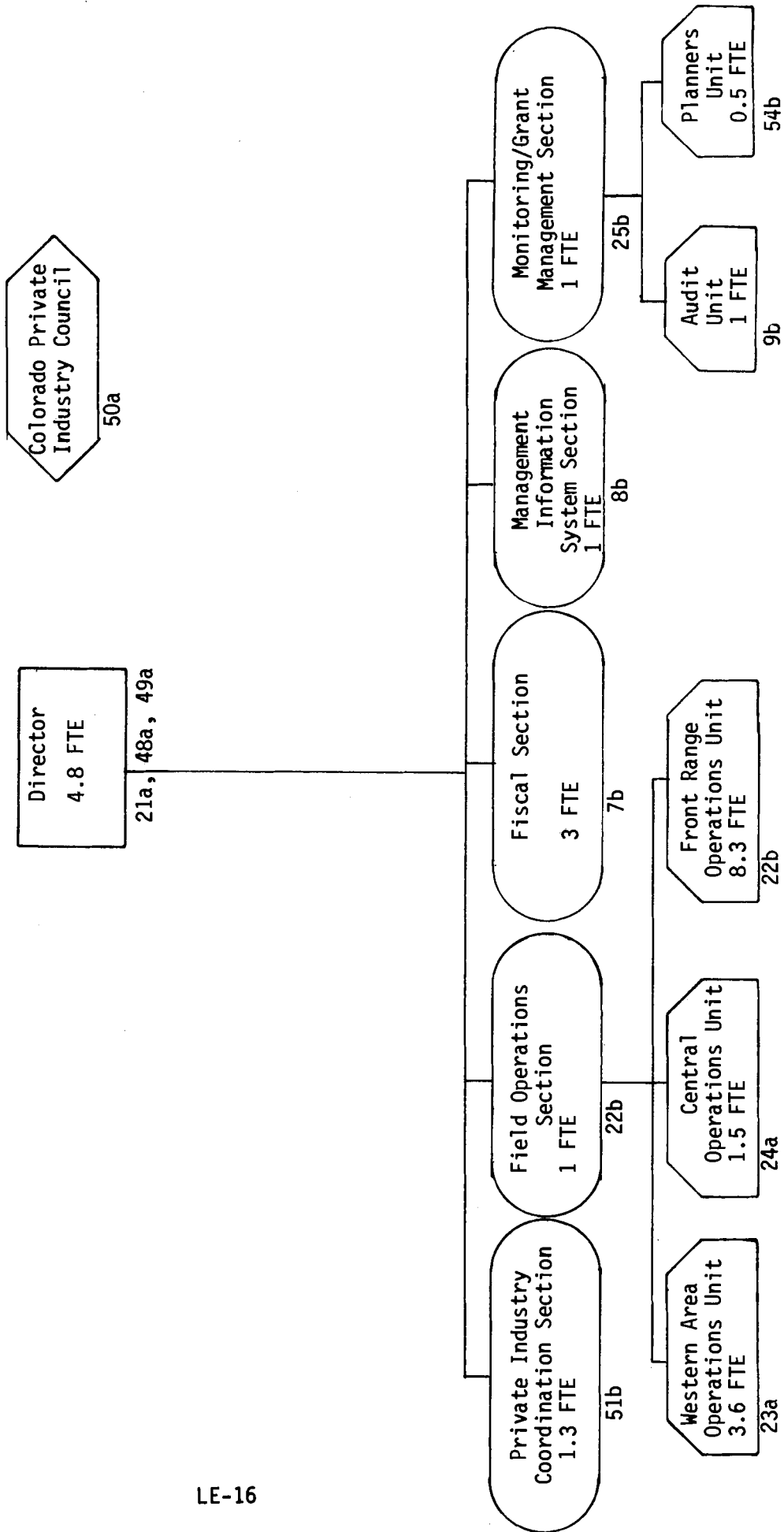

STATE COMPENSATION INSURANCE FUND

Total:
\$7,332 K-C
234 FTE

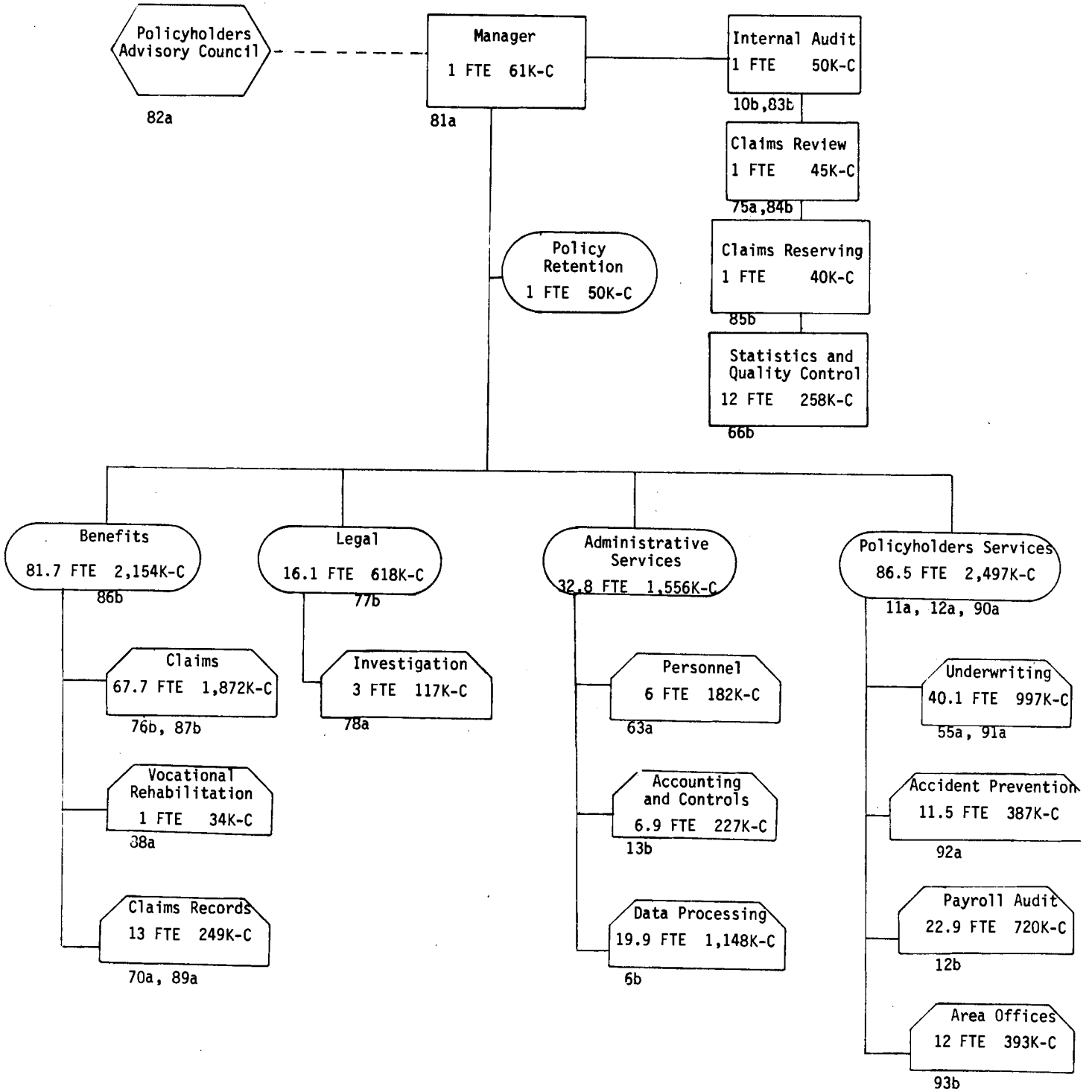

INDUSTRIAL COMMISSION

Total:
\$206 K-G
\$10 K-C

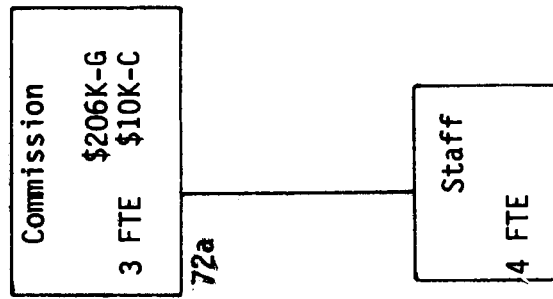

OFFICE OF MANPOWER PLANNING AND DEVELOPMENT

Totals:

\$2,105 K-F
18 FTE

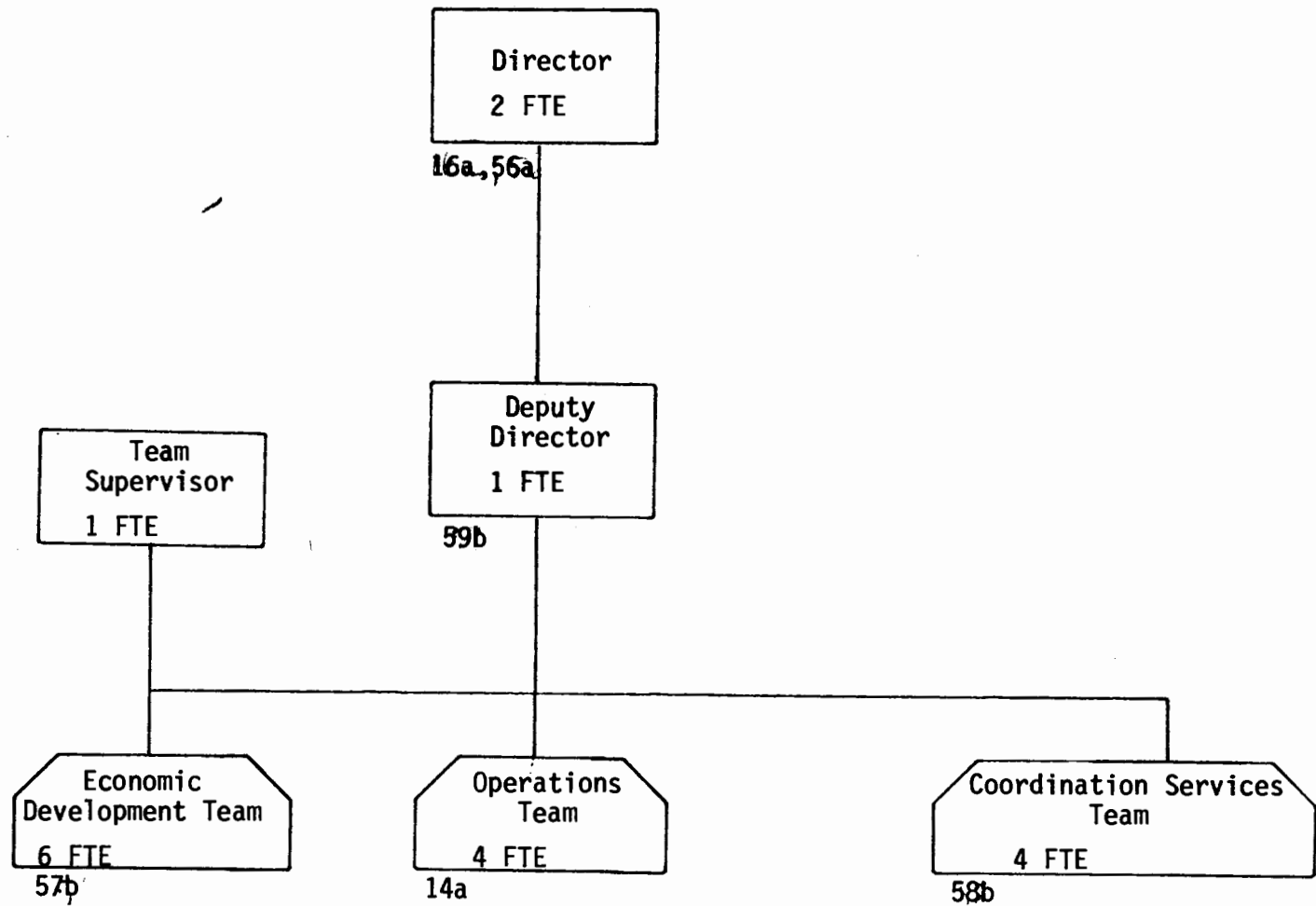

LE-19

DEPARTMENT OF LAW

	<u>Page</u>
<u>Performs Internal Administrative Services</u>	L-1
<u>Provides Legal Services to State Government and Represents the People of Colorado in Enforcement Activities</u>	L-1

DEPARTMENT OF LAW

Page

Performs Internal Administrative Services

L-1

Provides Legal Services to State Government
and Represents the People of Colorado
in Enforcement Activities

L-1

DEPARTMENT OF LAW

Performs Internal Administrative Services

1. Maintains a record of all official opinions and a register of all actions prosecuted or defended and maintains a status record of pending matters. (Office of the Attorney General, 24-31-101(1)(c), C.R.S.)
2. Appoints deputies and assistant attorneys general within the limits of appropriated funds. (Office of the Attorney General, 24-31-101(3), 24-31-103, C.R.S.)
3. Appoints the Uniform Consumer Credit Code administrator. (Office of the Attorney General, 5-6-103, C.R.S.)
4. Prepares and implements the department's budget and processes all accounting and payroll documents. (Administrative Section, 24-31-101, C.R.S.)
5. Provides general administrative services to the department. (Administrative Section, 24-31-101, C.R.S.)
6. Prepares computer programs and provides computer and information processing for the department. (Administrative Section, Computer and Text and Information Processing Units, 24-31-101, C.R.S.)
7. Completes searches of statutes, case law and attorney general opinions for department staff. (Administrative Section, 24-31-101, C.R.S.)

Provides Legal Services to State Government and Represents the People of Colorado in Enforcement Activities

8. Renders written legal opinions upon the request of the general assembly or either house, the governor, lieutenant governor, secretary of state, executive director of the department of revenue, state treasurer, state auditor or commissioner of education. (Office of the Attorney General, 24-31-101(1)(b), C.R.S.)
9. Renders written legal opinions to departments, divisions, boards, bureaus and agencies or their legal counsel and advisor. (Office of the Attorney General, 24-31-101(1)(a), C.R.S.)
10. Provides legal services to state agencies as designated by the attorney general. (Office of the Attorney General, 24-31-203(2), C.R.S.)

11. Notifies the general assembly of final judgements or settlements which require an appropriation for payment. (Office of the Attorney General, 24-10-113.5, C.R.S.)
12. Serves as a member of the State Board of Equalization. (Office of Attorney General, 39-9-101, C.R.S.)
13. Serves as a member of the Wildlife Board of Claims. (Natural Resources Section, 33-4-112(2), C.R.S.)
14. Supervises and represents the collection agency board. (Enforcement Section, U.C.C.C. Unit, 12-14-104; 24-31-101(1)(a), C.R.S.)
15. Enforces the Consumer Protection Act. (Enforcement Section, Antitrust and Consumer Protection Unit, 6-1-103 and 107, C.R.S.)
16. Files for an injunction or criminally prosecutes violations of the life care institution statutes. (Enforcement Section, Medicaid Fraud Unit, 12-13-117, C.R.S.)
17. Issues civil investigative demands under the organized crime control act. (Enforcement Section, Criminal Justice Unit, 18-17-107, C.R.S.)
18. Promulgates rules and regulations and enforces the provisions of the Unfair Practices Act. (Enforcement Section, Antitrust and Consumer Protection Unit, 6-2-111(4), (5), (6), C.R.S.)
19. Requests and represents the state before a statewide grand jury. (Enforcement Section, Criminal Justice Unit, 13-73-101, C.R.S.)
20. Represents the Colorado State Patrol. (Enforcement Section, Criminal Justice Unit, 24-31-101, C.R.S.)
21. Investigates demands for extradition. (Litigation Section, 16-19-105, C.R.S.)
22. Administers the Uniform Consumer Credit Code. (Enforcement Section, U.C.C.C. Unit, 5-6-107, C.R.S.)
23. Serves as legal counsel and advisor to the state board of education, the commissioner of education and upon request of the commissioner advises and represents any county school planning committee. (Human Resources Section, Education Unit, 22-30-134, and 24-31-101(1), C.R.S.)

24. Advises and represents the department of health. (Human Resources Section, Human Services Unit, and Natural Resources Section Environmental Unit, 25-1-112, C.R.S.)
25. Represents the department of labor and employment. (Human Resources Section, Labor and Civil Rights Unit, 24-31-101(1), C.R.S.)
26. Represents the industrial commission. (Human Resources Section, Labor and Civil Rights Unit, 8-1-138, 8-53-118 and 129, C.R.S.)
27. Represents and is legal advisor to both the department of personnel and the state personnel board. (Human Resources Section, Labor and Civil Rights Unit, 24-31-101, C.R.S.)
28. Serves as the legal adviser to the public employees retirement board. (Human Resources Section, Labor and Civil Rights Unit, 24-51-108, C.R.S.)
29. Represents the department of labor and employment in all civil and criminal actions concerning the employment security statutes. (Human Resources Section, Labor and Civil Rights Unit, 8-81-103, C.R.S.)
30. Represents and is the legal advisor of the president of the University of Colorado and the board of regents. (Human Resources Section, Education Unit, 23-20-110, C.R.S.)
31. Represents the Department of Social Services. (Human Resources Section, Human Services unit, 24-31-101, C.R.S.)
32. Represents and advises the department of corrections. (Human Resources Section, Corrections and Institutions Unit, 24-31-101, C.R.S.)
33. Represents and advises the department of institutions. (Human Resources Section, Corrections and Institutions Unit, 24-31-101, C.R.S.)
34. Prosecutes and defends all suits related to the department of revenue when requested by the executive director (Legal Services Section, Revenue Unit , 24-31-101(b) and 24-35-112, C.R.S.)
35. Prosecutes and defends all suits related to the secretary of state upon request. (Legal Services Section, Elected Officials and General Legal Services Unit, 24-31-101(1)(a), C.R.S.)

36. Prepares drafts for contracts, forms and other writings. (Legal Services Section, Contracts Unit, and Natural Resources Section, Environmental Unit, 24-31-101(c), C.R.S.)
37. Files actions to dissolve corporations upon certification by the secretary of state. (Legal Services Section, Elected Officials and General Legal Services Unit, 7-8-114(1), (2), C.R.S.)
38. Assists the secretary of state in making uniform interpretations of the elections code. (Legal Services Section, Elected Officials and General Legal Services Unit, 1-1-106(1)(c), C.R.S.)
39. Investigates and prosecutes violators of the municipal elections code. (Legal Services Section, Elected Officials and General Legal Services Unit, 31-10-1501, C.R.S.)
40. Upon the request of presidential electors advises them concerning their official duties. (Legal Services Section, 1-4-304(4), C.R.S.)
41. Investigates and prosecutes any violation of the Colorado election code. (Legal Services Section, Elected Officials and General Legal Services Unit, 1-13-101(2), C.R.S.)
42. Approves all legislative department contracts as to form. (Legal Services Section, Contracts Unit, 2-2-320(2), C.R.S.)
43. Makes arrangements for legal services outside of Colorado to collect inheritance and succession taxes. (Legal Services Section, Revenue Unit, 39-23-160, C.R.S.)
44. Brings suit to enjoin a foreign limited partnership from transacting business. (Legal Services Section, Elected Officials and General Legal Services Unit, 7-62-908, C.R.S.)
45. Brings suit to collect unpaid fees from public utilities. (Regulatory Law Section, P.U.C. Unit, 40-2-113, C.R.S.)
46. Approves the legality of all publication contracts entered into by the revisor of statutes' office. (Legal Services Section, Contracts Unit, 2-5-109, C.R.S.)
47. Prosecutes violators of the statutes governing special district elections. (Legal Services Section, Elected Officials and General Legal Services Unit, 31-1-843, C.R.S.)

48. Represents and advises the department of local affairs. (Legal Services Section, Elected Officials and General Legal Services Unit, 24-31-101, C.R.S.)
49. Represents and advises the state treasurer. (Legal Services Section, Elected Officials and General Legal Services Unit, 24-31-101, C.R.S.)
50. Represents and advises the office of state planning and budgeting. (Legal Services Section, Revenue Unit, 24-31-101, C.R.S.)
51. Represents and advises the department of military affairs. (Legal Services Section, Elected Officials and General Legal Services Unit, 24-31-101, C.R.S.)
52. Represents and advises the department of administration. (Legal Services Section, Elected Officials and General Legal Services Unit, 24-31-101, C.R.S.)
53. Represents the judicial department. (Legal Services Section, Elected Officials and General Legal Services Unit, 24-31-101, C.R.S.)
54. Prosecutes and defends all civil and criminal appeals where the state is a party or interested. (Litigation Section, 24-31-101(a), C.R.S.)
55. Prosecutes and defends all suits related to the governor, secretary of state, state treasurer, the department of revenue or when requested to do so by the commissioner of education. (Litigation Section, 24-31-101(b), C.R.S.)
56. Prosecutes and defends all civil and criminal appeals where the state is a party or interested. (Litigation Section, 24-31-101(a), C.R.S.)
57. Represents state employees who have become parties to a lawsuit due to acts arising out of their state employment. (Litigation Section, 24-31-101(4), C.R.S.)
58. Represents and advises the department of highways. (Natural Resources Section, Highway Unit, 43-1-208 and 35-42-101(1), C.R.S.)
59. Provides legal services for the highway commission. (Natural Resources Section, Highway Unit, 43-1-108 and 24-31-101(1), C.R.S.)
60. Represents and advises the state engineer. (Natural Resources Section, Water Unit, 37-80-116, 37-92-503(1)(a), C.R.S.)

61. Represents and advises the state board of land commissioners. (Natural Resources Section, Highway Unit, 36-4-112 and 36-1-121(2), C.R.S.)
62. Advises and is legal counsel for the Colorado water conservation board. (Natural Resources Section, Water Unit, 37-60-113 and 36-60-114, C.R.S.)
63. Files suit to enjoin the unlawful diversion of water outside of Colorado. (Natural Resources Section, Water Unit, 37-81-102, C.R.S.)
64. Represents and advises the department of natural resources. (Natural Resources Section, Water Unit and Environmental Unit, 24-31-101, C.R.S.)
65. Represents and brings suit on behalf of the oil and gas conservation commission. (Natural Resources Section, Environmental Unit, 34-60-109, C.R.S.)
66. Represents and brings suit on behalf of the water quality control commission. (Natural Resources Section, Environmental Unit, 25-8-607(1), C.R.S.)
67. Represents the department of health in matters concerning radiation control. (Natural Resources Section, Environmental Unit, 25-11-106, C.R.S.)
68. Represents and defends the department of agriculture. (Regulatory Law Section, 35-1-110; 24-31-101, C.R.S.)
69. Maintains concurrent jurisdiction with the various district attorneys over article 4 of title 12, C.R.S. (board of examiners of architects). (Regulatory Law Section, Licensing Unit, 12-4-113(3), C.R.S.)
70. Oversees and represents the public interest as it relates to charitable trusts. (Regulatory Law Section, 24-31-101(5), C.R.S.)
71. Represents and advises the state board of denial examiners. (Regulatory Law Section, Licensing Unit, 12-35-133 and 24-31-101(1), C.R.S.)
72. Represents and advises the Colorado mobile home licensing board. (Regulatory Law Section, Licensing Unit, 12-51.5-106, C.R.S.)

73. Represents the public utilities commission with regard to contract motor carriers. (Regulatory Law Section, P.U.C. Unit, 40-11-113 and 115, C.R.S.)
74. Represents and advises the Colorado dealer licensing board. (Regulatory Law Section, Licensing Section, 12-6-107, C.R.S.)
75. Represents the public utilities commission and is empowered to file suit to enforce its decisions. (Regulatory Law Section, P.U.C. Unit, 24-31-101(1); 40-7-101, 104, 109, C.R.S.)
76. Brings suit to revoke a railroad charter if a railroad violates article 12 of title 40. (Regulatory Law Section, P.U.C. Unit, 40-21-103, C.R.S.)
77. Represents, investigates or prosecutes violations of the towing carrier statutes on behalf of the public utilities commission. (Regulatory Law Section, P.U.C. Unit, 40-13-112, C.R.S.)
78. Files suit to enjoin any restraint of trade or commerce. (Enforcement Section, Antitrust and Consumer Unit, 6-4-105, C.R.S.)
79. Represents and advises the department of regulatory agencies. (Regulatory Law Section, P.U.C. Unit, Licensing Unit and Medical Unit, 31-24-101, C.R.S.)

DEPARTMENT OF LAW

Department Totals

\$3569.4 K-C
\$1225.2 K-G
207.5 FTE

8-7

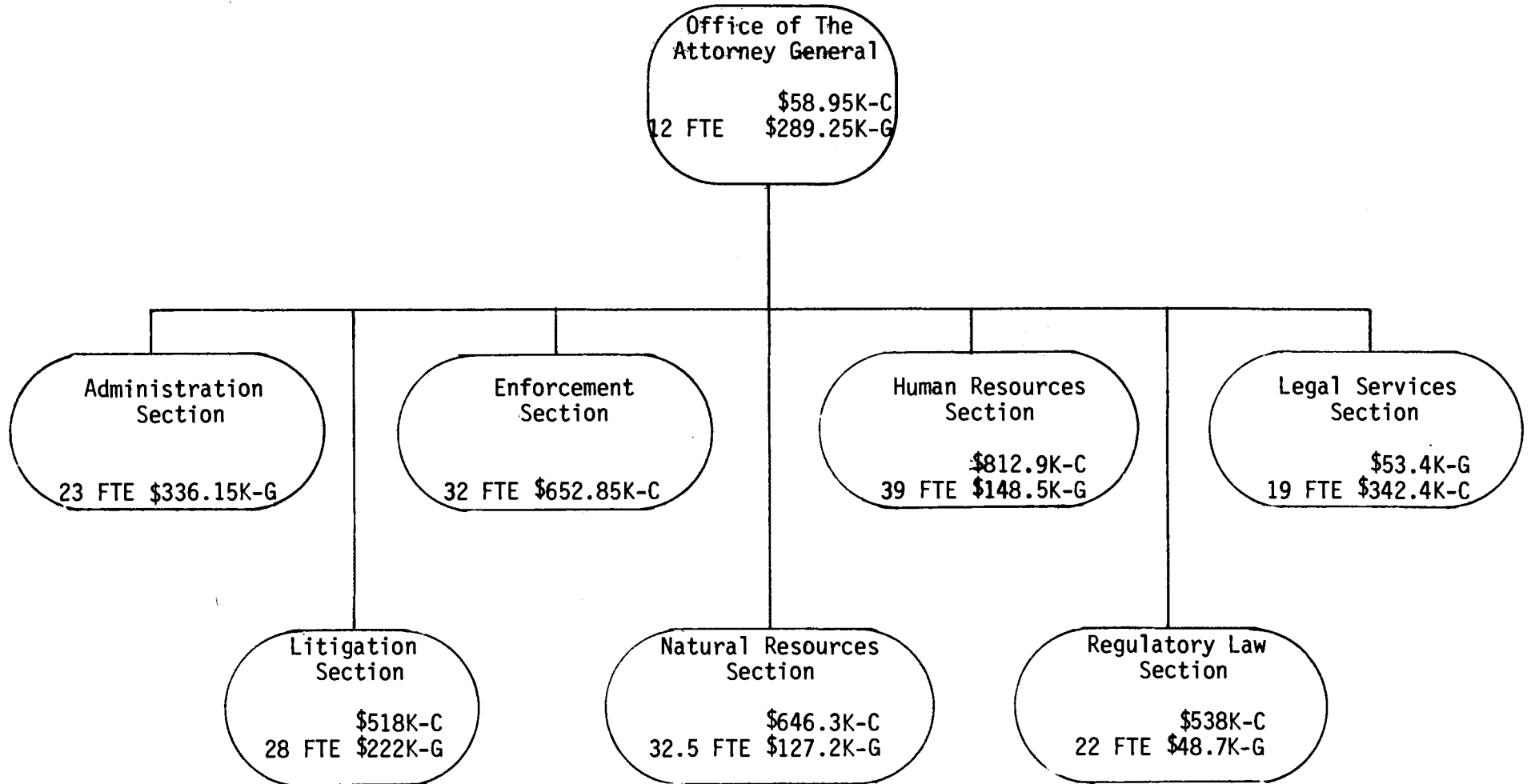

OFFICE OF THE ATTORNEY GENERAL

Section Totals

\$58.95 K-C
\$289.25 K-G
12 FTE

6-7

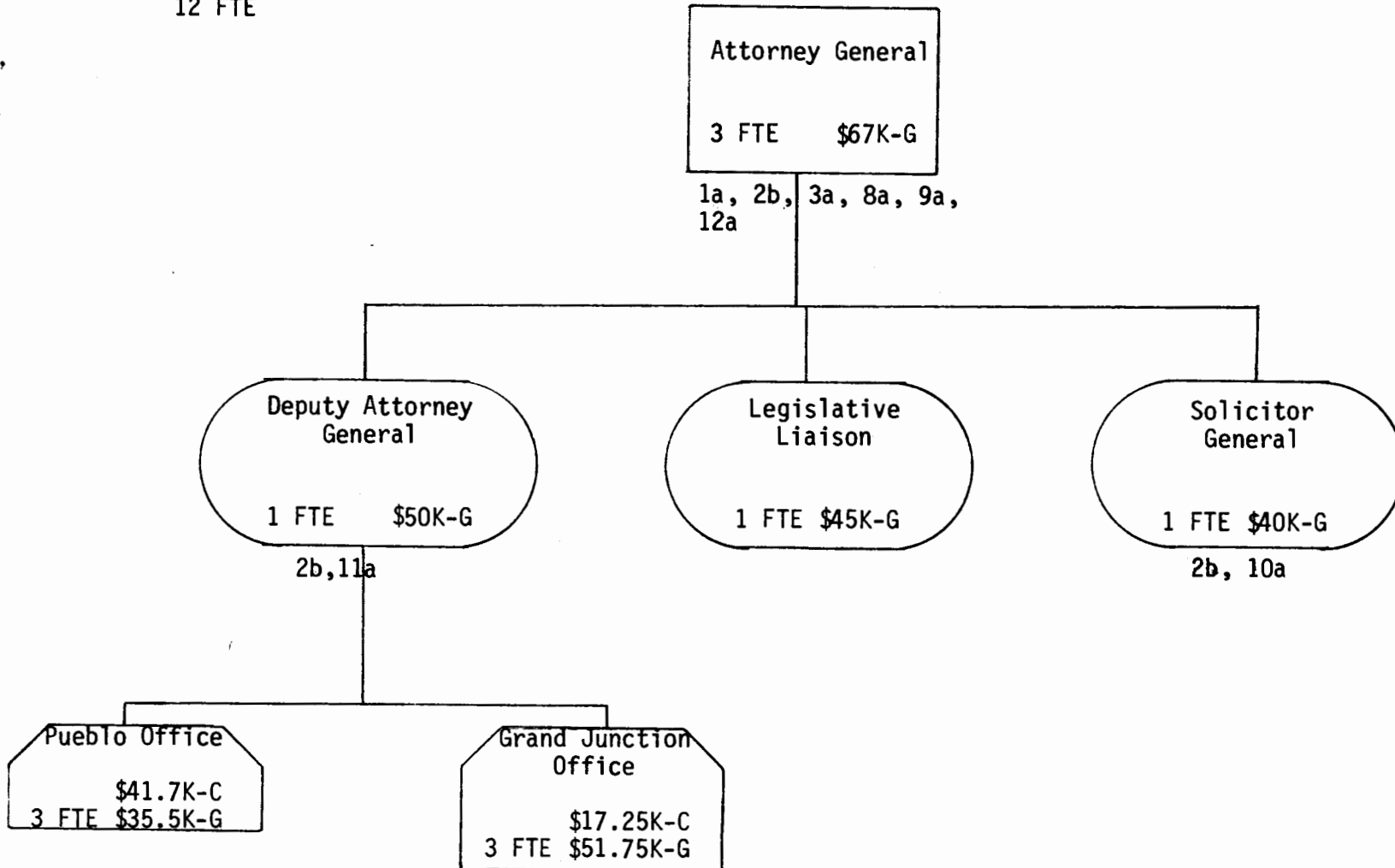

ADMINISTRATIVE SECTION

Section Totals

\$336.15 K-G
23 FTE

L-10

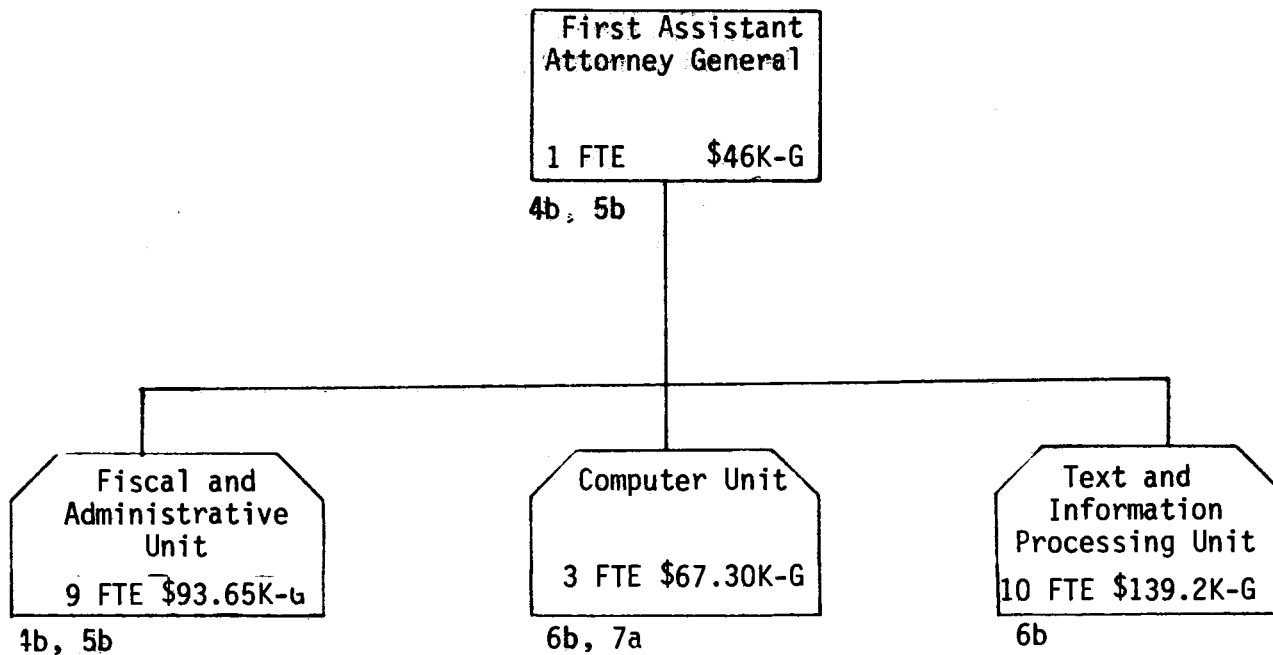

ENFORCEMENT SECTION

Section Totals

\$652.85 K-C
32 FTE

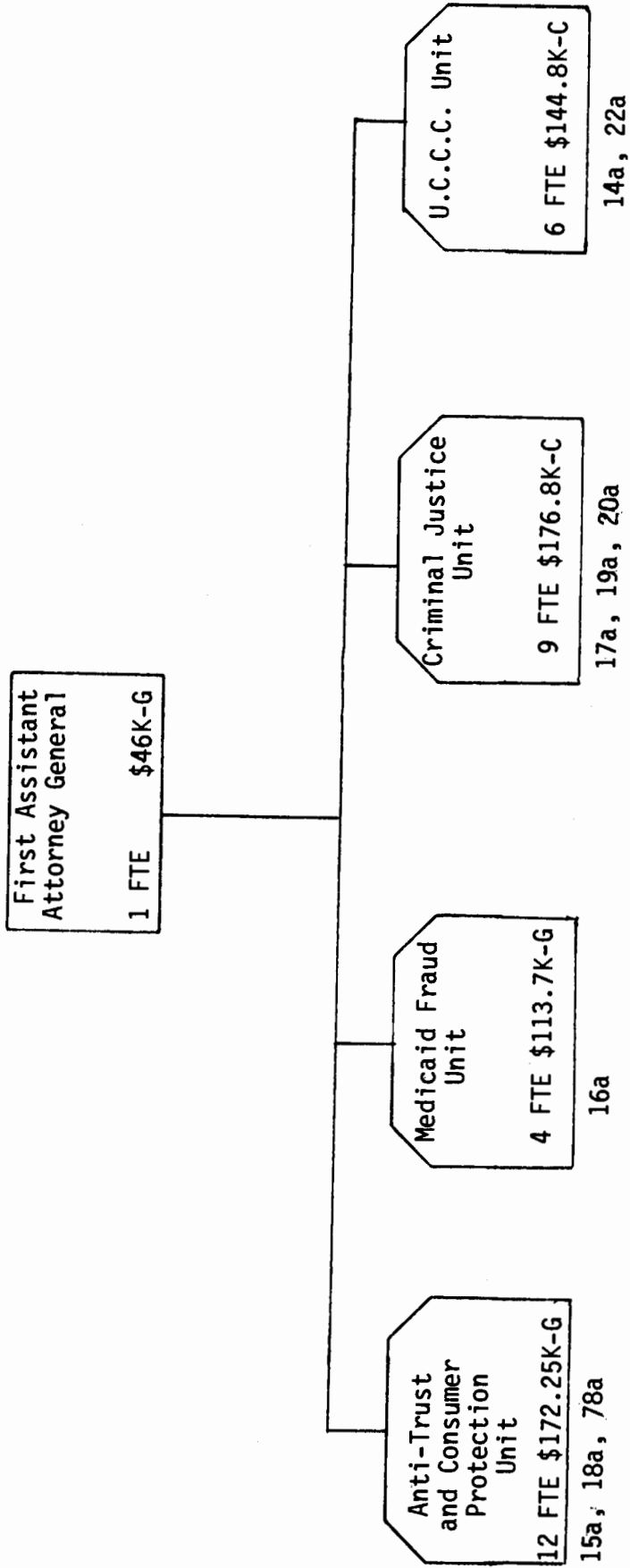

HUMAN RESOURCES SECTION

Section Totals

\$812.9 K-C
\$148.5 K-G
39 FTE

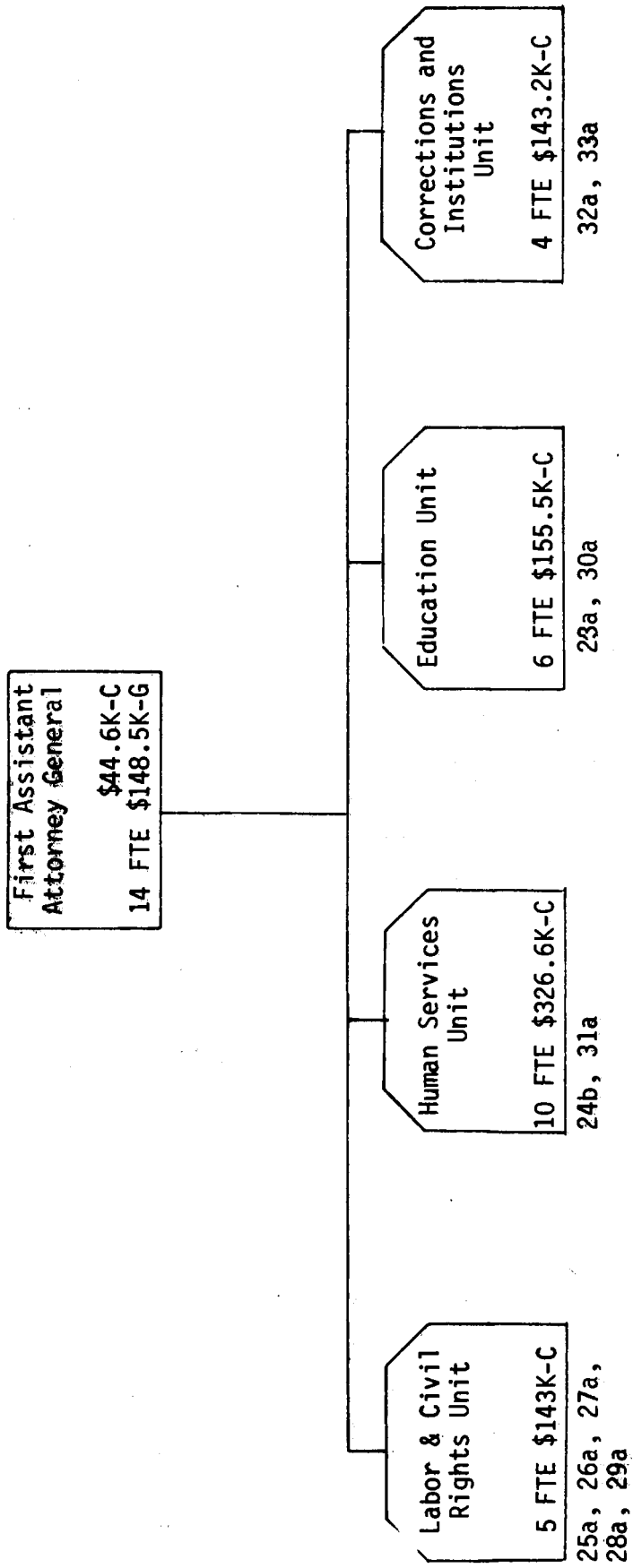

LEGAL SERVICES SECTION

Section Totals

\$53.4 K-G
\$342.4 K-C
19 FTE

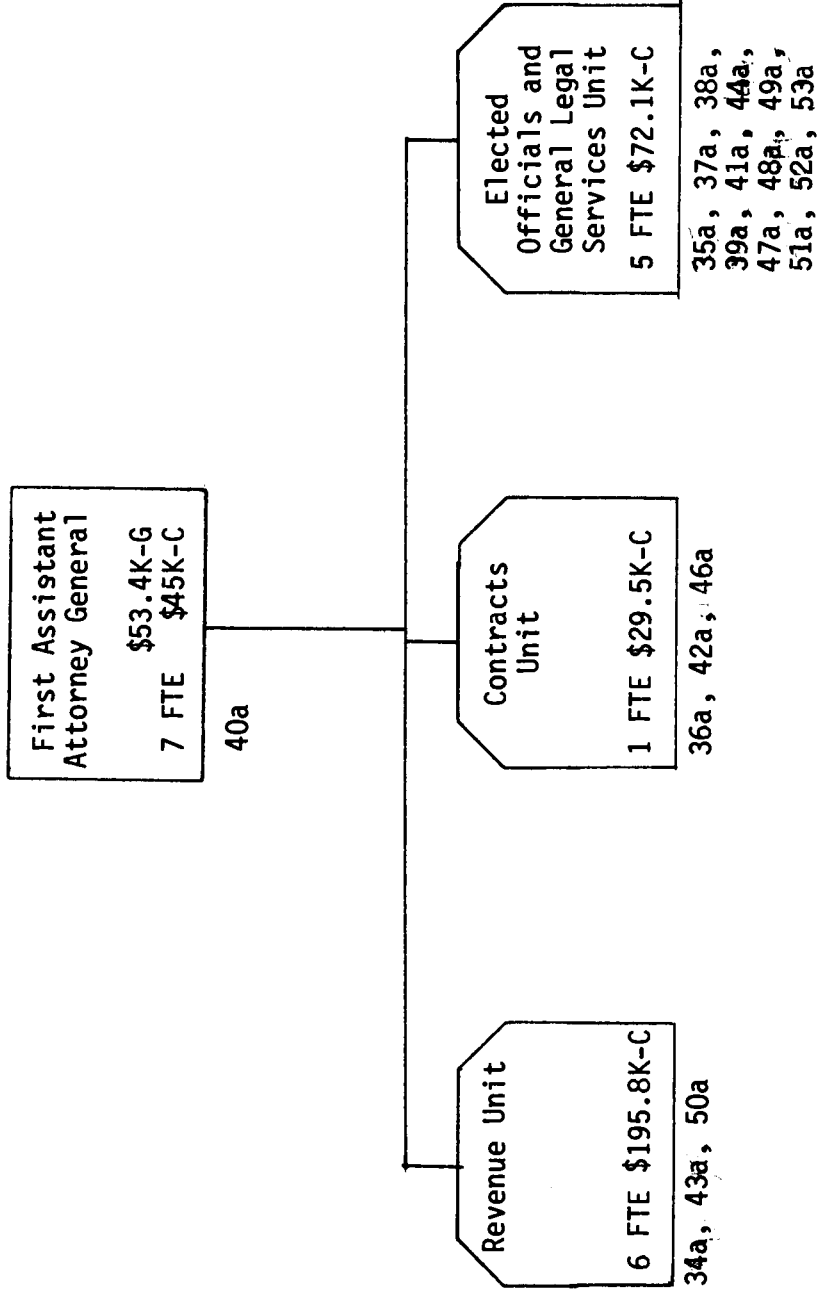

LITIGATION SECTION

Section Totals

\$518 K-C
\$222 K-G
28 FTE

Litigation Section
\$518K-C
28 FTE \$222K-G

21a, 54a, 55a,
56a, 57a,

NATURAL RESOURCES SECTION

Section Totals

\$646.3 K-C
\$127.2 K-G
32.5 FTE

First Assistant
Attorney General

\$42.1K-C
2 FTE \$20.5K-G

13a

Water Unit

\$197.2K-C
9 FTE \$38.1K-G

60a, 62a, 63a,
64b

Environmental
Unit

\$188.5K-C
10.5 FTE \$29.8K-G

24b, 35b, 64b,
65a, 66a, 67a

Highway Unit

\$218.5K-C
11 FTE \$38.8K-G

58a, 59a, 61a

L-15

REGULATORY LAW SECTION

Section Totals

\$538 K-C
\$48.7 K-G
22 FTE

First Assistant
Attorney General
\$46K-C
2 FTE \$12.2K-G

69a, 71a

P.U.C. Unit
\$107.2K-C
4 FTE \$16.1K-G

73a, 75a, 76a,
77a, 79b

Licensing
Unit
\$321.1K-C
12 FTE \$9.9K-G

69a, 71a, 72a,
74a

Medical Unit
\$64 K-C
4 FTE \$19.5 K-G

79b

L-16

LEGISLATIVE BRANCH

Exercises the Public Policy-making Power of the State

	<u>Page</u>
Law-making.....	LEG-1
Performs Management Functions.....	LEG-2

Provides Assistance to the Public
Policy-makers of the State

Fiscal Staff Assistance.....	LEG-3
Auditing.....	LEG-3
Administrative Duties.....	LEG-4
Assists Local Entities.....	LEG-4
Budget Formulation.....	LEG-5
General Staff Assistance.....	LEG-5
Depository for Legislative Records.....	LEG-7
Legal Assistance.....	LEG-7
Administrative Services.....	LEG-9
Publication Services.....	LEG-9

THE LEGISLATIVE BRANCH

Exercises the Public Policy - making Power of the State

Law-making

1. Exercises the law-making power of the state. (General Assembly; Article V, Section 1, Colorado Constitution)
2. Determines the annual budget for the operation of state government and appropriates sufficient funds. (General Assembly; Article V, Sections 32 and 33, Colorado Constitution and 24-75-101 and 303, C.R.S. 1973)
3. Submits to the voters proposed amendments to the state constitution for approval or rejection. (General Assembly, Article XIX, Section 2, Colorado Constitution)
4. Determines the level of annual financial assistance to local entities of government -- primarily school districts. (General Assembly; 22-50-103, C.R.S. 1973)
5. Confirms appointments by the governor to certain public offices. (Senate; 8-1-102 (1), 10-1-103.1 (1), 12-23-102, 12-38-104 (1), 12-41-105 (1), 12-60-102, 17-1-101 (1), 23-1-102 (2), 23-3.1-203 (2) (a), 23-15-104 (2), 23-30-101, 23-40-104 (1) (b), 23-41-109 (1), 23-50-102 (1), 23-60-104 (2) (a), 24-1-116 (1), 24-1-117 (1), 24-1-118 (1), 24-1-119 (1), 24-1-120 (1), 24-1-121 (1), 24-1-122 (1), 24-1-125 (1), 24-1-126 (1), 24-1-128 (1), 24-1-128.1 (1), 24-32-706 (2), 24-34-303, 24-35-207 (1), 24-50-103 (1), 24-60-2209, 25-1-103 (1), 25-3-504 (1) (a), 25-7-104 (1), 25-7-116 (3), 25-8-201 (1) (a), 25-25-104 (2), 26-1-107 (1) (a), 26-11-101 (1), 29-1-503 (1), 29-4-704 (2) (c), 33-1-106 (1), 33-30-103 (1), 34-32-105 (2), 34-60-104 (2) (a), 35-1-105 (1) (a), 35-75-104 (2) (a), 36-1-101.5, 37-95-104 (2) (a), 38-37-102 (1), 39-2-123 (2), 39-2-130 (1), 40-2-101 (1), 41-3-105 (6), and 43-1-103 (4), C.R.S. 1973)
6. Causes committees of the general assembly to study the powers, duties and functions of the principal departments of the executive branch in connection with investigating matters bearing on legislation and the operation of state and local government. (Senate and House of Representatives; 2-7-103, C.R.S. 1973)
7. Promotes uniformity in state laws. (Colorado Commission on Uniform State Laws; 2-3-604, C.R.S. 1973)

8. Makes a continuing study of the salaries, retirement benefits, expense allowances and other emoluments of the members of the general assembly, judges, district attorneys, and elected and appointed officials of the executive branch not included in the state personnel system. (Colorado State Officials' Compensation Commission; 2-3-805, C.R.S. 1973)
9. Recommends legislation pertaining to energy-related activities. (Colorado Energy Coordinating Council; 2-3-1103, C.R.S. 1973)

Performs Management Functions

10. Reports upon the credentials of newly elected members of the general assembly. (Credentials Committees of the House of Representatives and of the Senate; 2-2-303, C.R.S. 1973)
11. Appoints employees of the House of Representatives and of the Senate. (Senate and House of Representatives; 2-2-305, C.R.S. 1973)
12. Designates and assigns space in the capitol buildings group and on the grounds thereof. (Senate and House of Representatives; 2-2-321, C.R.S. 1973)
13. Examines candidates for the position of state auditor. (Legislative Audit Committee; 2-3-101 (3) (a), C.R.S. 1973)
14. Appoints a joint budget committee staff director. (Joint Budget Committee; 2-3-204, C.R.S. 1973)
15. Appoints a director of research who is responsible to the council for the collection and assembling of data and the preparation of reports for use by the general assembly. (Legislative Council; 2-3-304, C.R.S. 1973)
16. Appoints a director of the Legislative Drafting Office and oversees the operations of the legislative drafting office. (Legal Services Committee, 2-3-502, C.R.S. 1973)
17. Appoints a revisor of statutes and oversees activities of the revisor. (Legal Services Committee; 2-3-701, C.R.S. 1973)
18. Participates as a member of the Council of State Governments and the National Conference of State Legislatures. (Legislative Council; 2-3-311, C.R.S. 1973)

Provides Assistance to the Public Policy - makers of the State

Fiscal Staff Assistance

Auditing

19. Conducts or causes to be conducted post audits of all financial transactions and accounts kept by or for all departments, institutions, and agencies of the state. (Legislative Audit Committee; 2-3-101 and 103, C.R.S. 1973)
20. Conducts a performance audit of three executive departments every other year or any department or agency when designated by the general assembly or the Legislative Audit Committee. (Legislative Audit Committee; 2-7-107, C.R.S. 1973)
21. Evaluates the investments of the public school fund. (State Auditor; 2-3-103 (5), C.R.S. 1973)
22. Reviews the expenditures of the Colorado Health Facilities Authority every two years. (Legislative Audit Committee; 25-25-127, C.R.S. 1973)
23. Retains an auditor to audit the State Compensation Insurance Fund. (State Auditor; 8-54-124 (2), C.R.S. 1973)
24. Audits the student loan guarantee program, the program of financial assistance, and the Colorado student incentive grant program at participating institutions of higher education. (State Auditor; 23-3.1-109, 23-3.3-102 (4), and 23-3.5-104, C.R.S. 1973)
25. Acts on allegations that governmental agencies are in noncompliance with the "Public Works Fiscal Responsibility Accounting Act of 1981". (Legislative Audit Committee; 24-16-107, C.R.S. 1973)
26. Causes to be conducted a performance audit of the Department of Personnel and the State Personnel Board every four years. (Legislative Audit Committee; 24-50-103.5 (2), C.R.S. 1973)
27. Acts on allegations that a governmental agency is in violation of the "Construction Bidding Public Projects Act". (Legislative Audit Committee; 24-92-111, C.R.S. 1973)
28. Periodically audits the costs of the alcohol and drug driving safety programs. (State Auditor; 42-4-1202 (5) (d), C.R.S. 1973)

29. Reviews activities and reports from the office of the state auditor. (Legislative Audit Committee; 2-3-101 (3) (b), C.R.S. 1973)
30. Causes to be conducted a performance audit of the automobile inspection and readjustment program by January 1, 1987. (Legislative Audit Committee; 42-4-316, C.R.S. 1973)

Administrative Duties

31. Serves as a member of the Public Employees' Retirement Board. (State Auditor; 24-51-103 (1), C.R.S. 1973)
32. Keeps a complete set of records on the fiscal transactions of his office and a complete file of copies of all audit reports. (State Auditor; 2-3-108 (3), C.R.S. 1973)
33. Serves as an ex officio member and chairman of the advisory committee on governmental accounting. (State Auditor; 29-1-503 (3), C.R.S. 1973)
34. Serves on the board of directors of the Colorado Housing Finance Authority. (State Auditor; 29-4-704 (2), C.R.S. 1973)

Assists Local Entities

35. Formulates, prescribes, publishes, and distributes to each unit of local government a classification of accounts and, upon request, assists local governments in implementing the classification of accounts. (State Auditor; 29-1-504, C.R.S. 1973)
36. Examines audit reports of local governments. (State Auditor; 29-1-607, C.R.S. 1973)

Budget Formulation

37. Makes estimates of revenue from existing and proposed taxes. (Joint Budget Committee; 2-3-203, C.R.S. 1973)
38. As the permanent fiscal and budget review agency of the general assembly, studies the management, operations, programs, and fiscal needs of Colorado state government. (Joint Budget Committee; 2-3-203, C.R.S. 1973)
39. Holds hearings and reviews the executive budget and budget requests of each state agency and makes recommendations to the general assembly. (Joint Budget Committee; 2-3-203, C.R.S. 1973)

40. Contracts with a consultant, on a yearly basis, for the development of a computerized budget information system. (Legislative Council; Joint Rule of the General Assembly)
41. Reviews and makes a report to the general assembly on the state Board of Education's certification of the equalization program support level and the amount of state funds required to be appropriated. (Legislative Council Staff; 22-50-105 (1) (a) (XI) and (1) (b), C.R.S. 1973)
42. Reviews the state's fund structure. (Joint Budget Committee; 2-3-203, C.R.S. 1973)
43. Implements an on-going review procedure based on zero-based budget programming. (Joint Budget Committee; 2-3-204, C.R.S. 1973)

General Staff Assistance

44. Provides staff assistance to all legislative committees. (Legislative Council Staff; 2-3-304, C.R.S. 1973, and Rules of the House of Representatives and of the Senate)
45. Collects information concerning government and the general welfare of the state. (Legislative Council Staff; 2-3-303, C.R.S. 1973)
46. Provides staff assistance to the State Officials Compensation Commission. (Legislative Council Staff; 2-3-806, C.R.S. 1973)
47. Provides printing and duplicating services to the general assembly and its staff agencies. (Legislative Council, Print Shop; no statutory mandate)
48. Maintains a joint reference library for the use of the general assembly and its agencies. (Legislative Council Staff; 2-3-203, C.R.S. 1973)
49. Provides staff assistance to the Colorado Energy Coordination Council. (Legislative Council Staff; 2-3-1103, C.R.S. 1973)
50. Makes revenue estimates for use by the general assembly. (Legislative Council Staff; 2-3-303, C.R.S. 1973)
51. Submits a reapportionment plan of the regional transportation district board districts to the General Assembly if the board fails to apportion itself by April 15 of the second year following each federal census. (Legislative Council and Legislative Drafting Office; 32-9-111 (1)(a), C.R.S. 1973)

52. Maintains a centralized legislative accounting service for the processing of vouchers and preparing all related documents for the legislative department. (Legislative Council; 2-3-1103, C.R.S. 1973)
53. Provides staff services for the Policemen's and Firemen's Pension Reform Commission. (State Auditor's Office, Legislative Council, and Legislative Drafting Office; 31-30-901 (1), C.R.S. 1973)
54. Approves payroll vouchers and vouchers for per diem payments incurred in connection with attendance by legislators at meetings for which reimbursement can be claimed. (Director of Research, Legislative Council; 2-2-307 (7), C.R.S. 1973)
55. Conducts inventories of all state agencies and activities which affect the research, development, or implementation of energy policy of this state and determines whether there is duplication of effort among the agencies. (Colorado Energy Coordinating Council; 2-3-103, C.R.S. 1973)
56. Provides staff assistance to joint legislative oversight committees in their study of the activities of the principal departments of the executive branch. (Legislative Council Staff; 2-4-104 and 2-7-104, C.R.S. 1973)
57. Provides the general assembly and its staff with a computerized budget information system. (Legislative Council, Computerized Legislative Evaluation and Analysis Resource (CLEAR); Joint Rules of the House and Senate)
58. Provides the general assembly with staff assistance. (Secretarial Staff, Senate and House of Representatives; Joint Rules of the House and Senate)

Depository for Legislative Records

59. Prepares and files with the secretary of state copies of census maps showing each representative and senatorial legislative district and retains on file copies of the same. (Legislative Council Staff; 2-2-205, C.R.S. 1973)
60. Serves as official custodian of all magnetic tapes of all legislative meetings held in the capitol building. (Director of Research, Legislative Council; Joint Rules of the General Assembly)
61. Maintains six copies of reports required to be made to the general assembly. (Legislative Council, Joint Legislative Library; 24-30-208 (a), C.R.S. 1973)

62. Prepares and files with the secretary of state copies of census maps showing each congressional district and retains on file copies of the same. (Legislative Council; 2-1-101 (7), C.R.S. 1973)

Legal Assistance

63. Provides legal assistance to the general assembly including special projects in legal research and writing. (Legislative Drafting Office; 2-3-504, C.R.S. 1973)
64. Drafts or aids in drafting legislative bills, amendments, resolutions, memorials, and tributes. (Legislative Drafting Office; 2-3-504, C.R.S. 1973)
65. Prepares, at the request of any legislative committee, summaries of existing laws. (Legislative Drafting Office; 2-3-504, C.R.S. 1973)
66. Prepares drafts of proposed legislation for legislative interim committees appointed by the legislative council. (Legislative Drafting Office; 2-3-504, C.R.S. 1973)
67. Provides drafting and legal research services to joint legislative oversight committees. (Legislative Drafting Office; 2-7-104, C.R.S. 1973)
68. Assists in designating a proper title, ballot title, submission clause, and summary for proposed initiated laws and constitutional amendments. (Director, Legislative Drafting Office; 1-40-101 (2), C.R.S. 1973)
69. Serves as ex officio secretary to the Colorado Commission on uniform State Laws. (Director, Legislative Drafting Office; 2-3-603, C.R.S. 1973)
70. Retains and supervises legal counsel to represent or otherwise render legal services to the general assembly, either house thereof, its committees, or any member or agency of the legislative branch. (Committee on Legal Services; 2-3-1001, C.R.S. 1973)
71. Reviews rules and regulations promulgated by executive agencies to determine whether the rule or regulation is within the power delegated to the agency and as authorized by law. (Legislative Drafting office; 24-4-103 and 24-4-108, C.R.S. 1973)
72. Establishes a procedure for review of rules and regulations to determine whether they conflict with statutes adopted or amended after the department's rules have been reviewed. (Committee on Legal Services; 24-4-108 (7), C.R.S. 1973)

73. Acts as a committee of reference for any bill introduced as a result of the rule review process. (Committee on Legal Services; 24-4-103 (8) (d), C.R.S. 1973)
74. Reviews and comments on the original drafts of all initiative petitions submitted by the proponents for proposed laws or amendments to the state constitution. (Directors, Legislative Council and Legislative Drafting Office; 1-40-101 (1), C.R.S. 1973)
75. Examines the statutes and judicial decisions to discover defects and anachronisms and recommends changes to modify or eliminate antiquated and inequitable rules of law. (Statutory Revisions Committee; 2-3-902, C.R.S. 1973)
76. Serves as an ex officio member of the statutory revision committee. (Revisor of Statutes; 2-3-901, C.R.S. 1973)
77. Reviews all bills, makes suggestions, and recommends changes, corrections, or revisions after passage by either house of the general assembly. (Office of Revisor of Statutes; Joint Rules 3 and 16 of the Senate and House of Representatives)
78. Prepares and submits annual revisor's bill for amendment or repeal of obsolete, imperfect, obscure, or doubtful laws. (Revisor of Statutes; 2-5-104, C.R.S. 1973)
79. Aids and assists the legislative drafting office in bill drafting, and aids and assists in the enrolling and engrossing of bills. (Office of Revisor of Statutes; 2-3-704, C.R.S. 1973)

Administrative Services

80. Prepares a digest of laws enacted by the general assembly. (Legislative Drafting Office; 2-3-504, C.R.S. 1973)
81. Maintains complete legislative records on bills, resolutions, and memorials considered and enacted by the general assembly, and other legislative actions. (Legislative Drafting Office; 2-3-504 (1) (e), C.R.S. 1973)

Publication Services

82. Causes to be published the proceedings of the general assembly. (Senate and House of Representatives; 2-2-310 through 311, C.R.S. 1973)
83. Provides a Code of Colorado Regulations and a Colorado Register to each executive department, legislative agency

and board of county commissioners. (General Assembly; 24-4-103 (1) (k), C.R.S. 1973)

84. Publishes an annual "Appropriations Report" which expresses legislative intent and program guidance for agencies of the executive branch in implementing the appropriations acts of the general assembly. (Joint Budget Committee; 2-3-203, C.R.S. 1973)
85. Compiles, edits, arranges, and prepares for publication, under the supervision and direction of the Committee on Legal Services, all laws of the state of a general and permanent nature as Colorado Revised Statutes 1973. (Revisor of Statutes; 2-3-702 and 2-5-101 (1), C.R.S. 1973)
86. Arranges and prepares for publication of the session laws. (Revisor of Statutes; 24-70-223 (1), C.R.S. 1973)
87. Contracts for the printing, binding, and packaging of Colorado Revised Statutes 1973 and supplements and other publications ancillary thereto. (Committee on Legal Services; 2-5-105, C.R.S. 1973)
88. Establishes the public sale price for C.R.S. 1973 and the session laws. (Committee on Legal Services; 2-5-111 and 24-70-225, C.R.S. 1973)
89. Prepares, for approval by the Committee on Legal Services, the official list of public officials and agencies who receive sets of C.R.S. 1973 and volumes of session laws for official use. (Revisor of Statutes; 2-5-116 and 24-70-224, C.R.S. 1973)
90. Authorizes printing and distribution of portions of the statutes upon application by any person, agency, or political subdivision. (Committee on Legal Services; 2-5-118, C.R.S. 1973)

COLORADO GENERAL ASSEMBLY

Totals:

\$4,539K
188 FTE
65 PTE

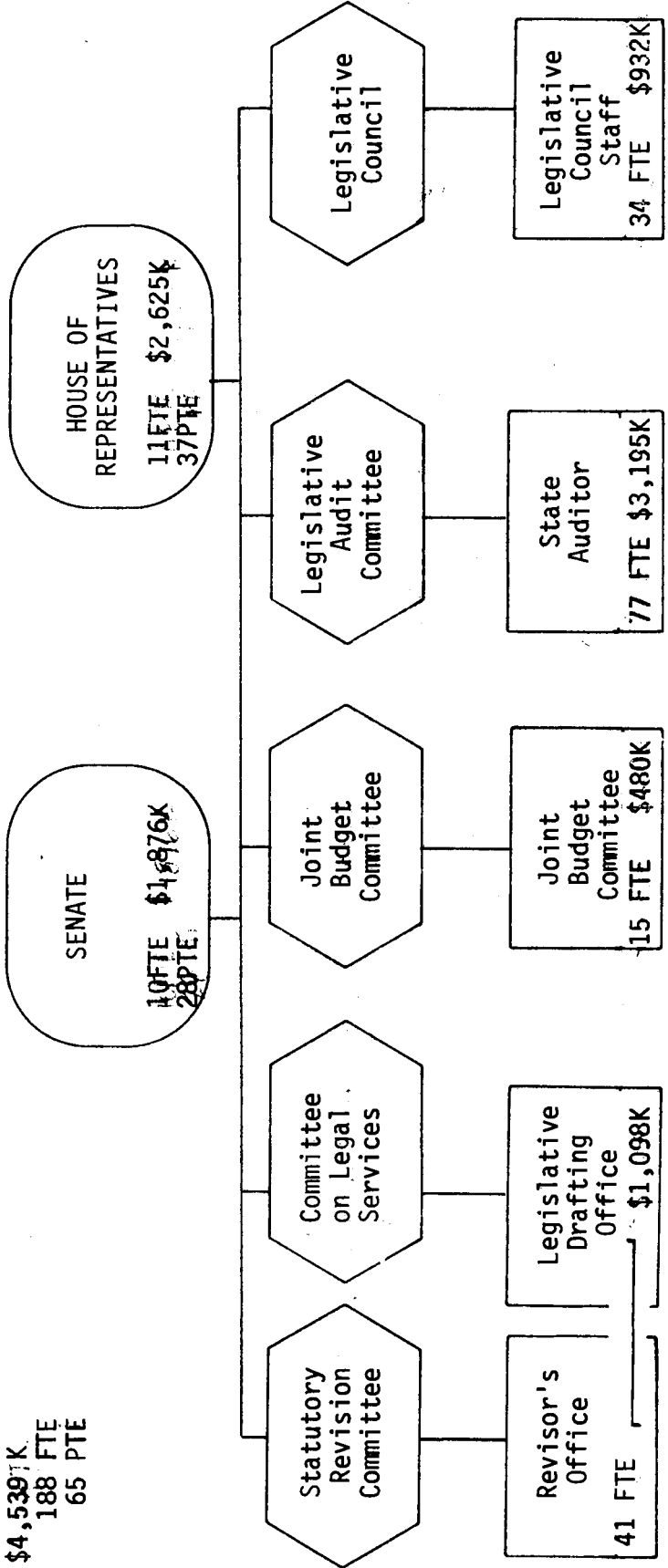

21 FTE
65 PTE*
\$4,539 K-G

SENATE
\$1,323K

HOUSE OF REPRESENTATIVES
\$2,035K

1b,2b,3b,12b, 4b,6b,11b,83b

1b,2b,3b,4b,12b, 5b,6b,11b,83b

Computerized Legislative Evaluation and Analysis Resource
\$307,000K

Legislative Committees

Credentials Committee

Colorado Energy Coordinating Council

57a

10a

9a,55a

LEG-11

Commission on Uniform State Laws
\$14K

Colorado State Officials' Compensation Commission

Senate Support Staff
10 FTE \$395K
28 PTE*

House Support Staff
11 FTE \$430K
37 PTE*

7a

8a

58b

58b

* PTE means part-time employees.

Totals:
\$3,195 K-G
77 FTE

STATE AUDITOR

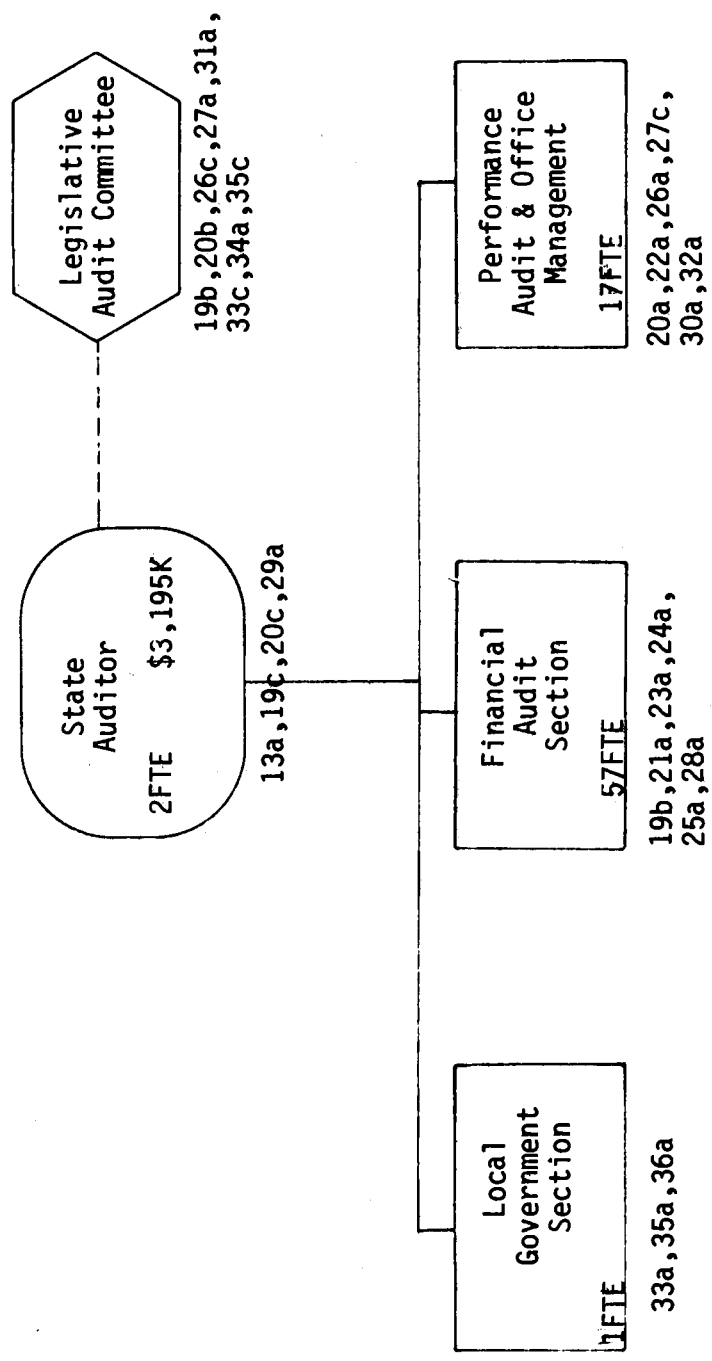

Totals:

\$480K
15 FTE

JOINT BUDGET COMMITTEE

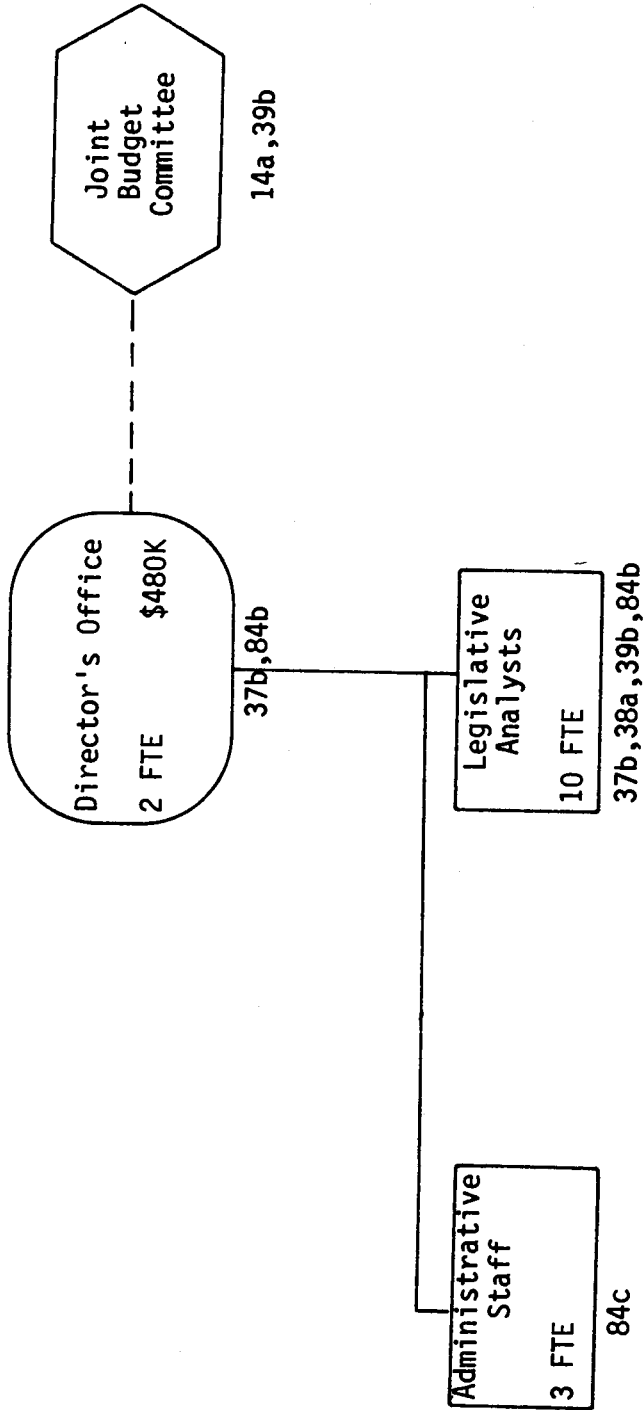

Totals:

34 FTE
\$932 K

LEGISLATIVE COUNCIL

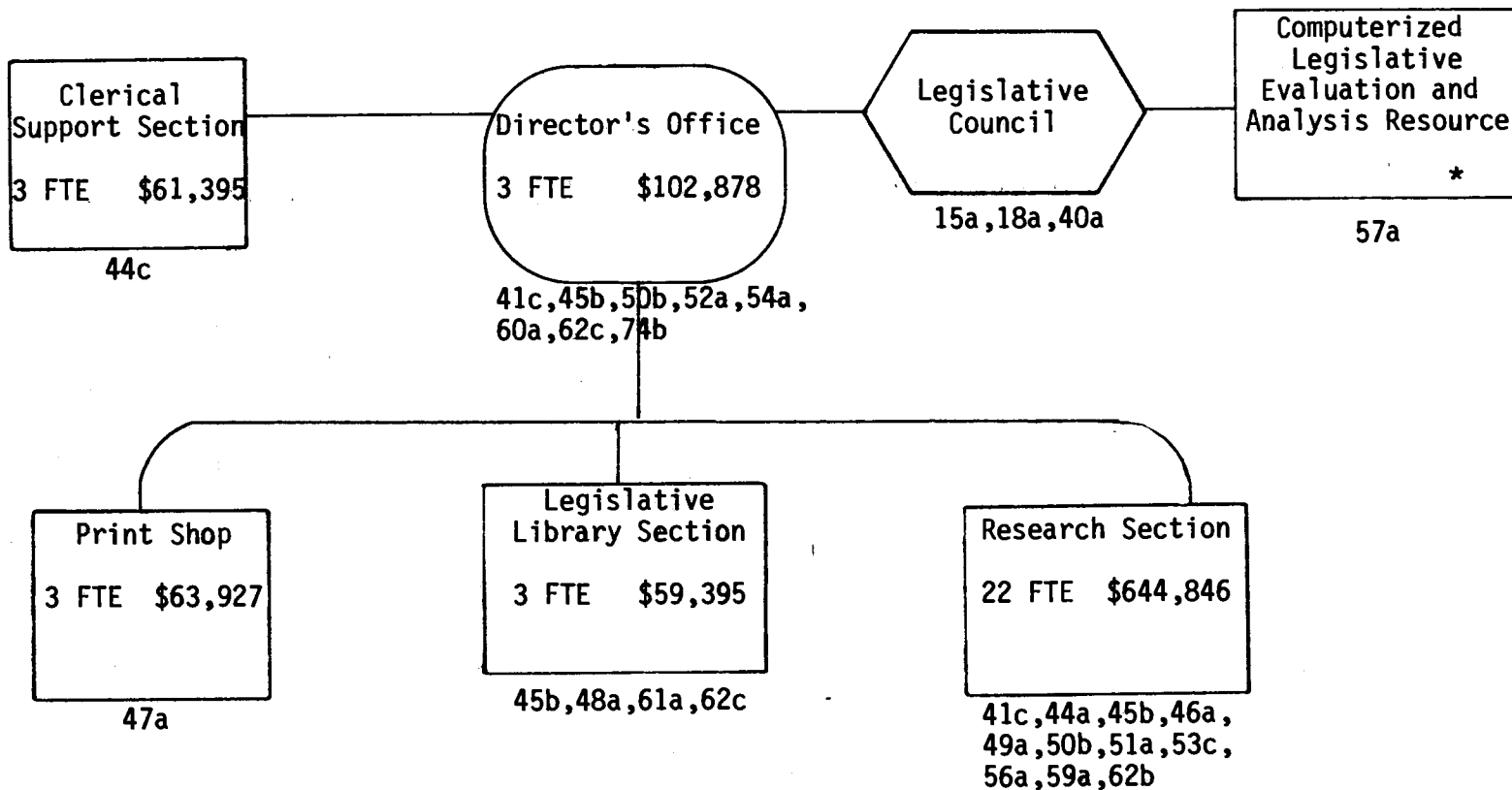

LEG-14

* Funding for this function is provided for in the budget of the General Assembly.

Totals:

41 FTE
\$1,098 K

LEGISLATIVE DRAFTING OFFICE/OFFICE OF REVISOR OF STATUTES

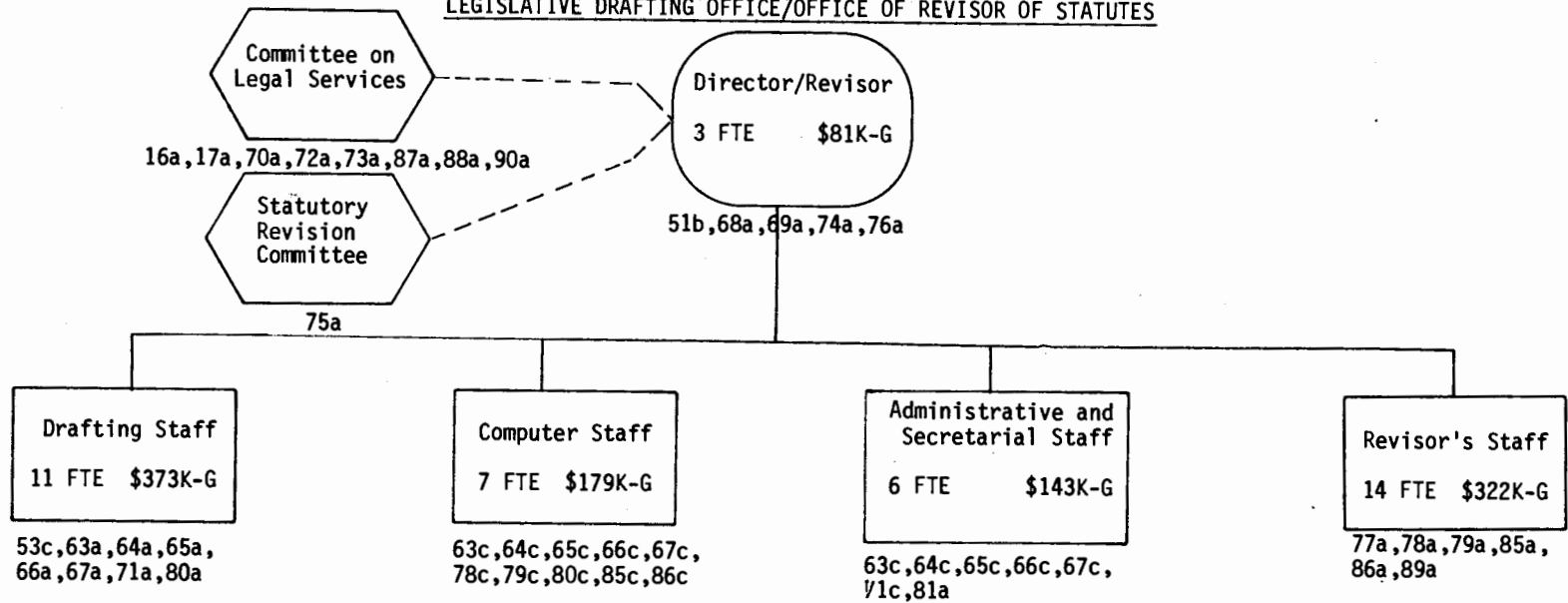

LEG-15

DEPARTMENT OF LOCAL AFFAIRS

Administers or Coordinates the Administration
of State Assistance to Local Governments

	<u>Page</u>
Executive Management.....	LA-1
Intraagency Coordination and Management.....	LA-1
Grants and Other Funds.....	LA-2
Taxation Questions.....	LA-3
Advisory Services.....	LA-3

Administers Programs of
Assistance to Local Governments

Funds Distribution.....	LA-4
Business Development.....	LA-4
Certification.....	LA-5
Enforcement.....	LA-6
Hearings.....	LA-6
Property Tax.....	LA-6
Estate Tax.....	LA-7
Land Use.....	LA-7
Housing.....	LA-7
Information Services.....	LA-8
Automated Data Processing.....	LA-8
Criminal Justice.....	LA-9
Local Government.....	LA-9
Energy Conservation.....	LA-10
Reports.....	LA-10
Property Values.....	LA-11
Research and Evaluation.....	LA-11
Housing.....	LA-11
Law Enforcement.....	LA-11
Property Tax.....	LA-12
Rules, Regulations and Standards.....	LA-12

Provides Technical Assistance
to Local Governments

Community Development.....	LA-13
Land Use.....	LA-13
Law Enforcement.....	LA-13
Property Taxation.....	LA-14
Other Local Government Operations.....	LA-14

Provides Training to Local Government Officials

Assessors.....	LA-15
Law Enforcement.....	LA-15

DEPARTMENT OF LOCAL AFFAIRS

Administers or Coordinates the Administration of State Assistance to Local Governments

Executive Management

1. Provides intra- and inter-departmental coordination and support of public safety activities and programs. (Office of Executive Director; 24-1-125, C.R.S. 1973)
2. Provides intra- and inter-departmental cooperation in energy and mineral development and socio-economic impact programs and issues. (Office of Executive Director; 24-1-125, C.R.S. 1973)
3. Provides intergovernmental coordination, cooperation, and problem-solving assistance to local and federal government and to law enforcement officials. (Office of Executive Director; 24-1-125, C.R.S. 1973)
4. Provides cooperation, coordination and problem-solving support to business, industry, and community groups affected by the department's activities and federal activities. (Office of Executive Director; 24-1-125, C.R.S. 1973)
5. Provides oversight and coordination of all federal grants and projects within the department. (Office of Executive Director, Accounting and Budgeting; 24-1-125, C.R.S. 1973)
6. Coordinates and administers support to various executive and legislative projects and activities including the Commission on State and Local Finance, the Governor's Blue Ribbon Panel, the Front Range Project, the Energy Coordinating Council, the Cumulative Impacts Task Force, and various other committees. (Office of Executive Director; 24-1-125, C.R.S. 1973)
7. Submits recommendations concerning the administration and enforcement of the property tax laws to the governor by December 1 of each year. (Division of Property Taxation, Property Tax Administrator; 39-2-118, C.R.S. 1973)

Intraagency Coordination and Management

8. Provides administrative and operational direction for the Colorado Bureau of Investigation which includes the assembling of resources and control of program development. (Colorado Bureau of Investigation, Administration Section; 24-32-404, C.R.S. 1973)

9. Provides supervision and control for the Colorado Law Enforcement Training Academy with the Chief of the Colorado State Patrol designated as superintendent. (Colorado Law Enforcement Training Academy, Administration Section; 24-32-602, C.R.S. 1973)
10. Administers all functions of the Colorado Law Enforcement Training Academy. (Colorado Law Enforcement Training Academy, Administration Section; 24-32-609, C.R.S. 1973)
11. Coordinates and administers overall responsibility for law enforcement training programs at the in-service level. (Colorado Law Enforcement Training Academy, Training Section; 24-32-609 (1) (g), C.R.S. 1973)
12. Coordinates reviews of comments on notices of intent to apply for federal funds (A-95), environmental impact statements (EIS), housing and subdivision proposals, and the Colorado Review Process (CRP). (Division of Local Government, Planning Section; 24-32-1201, C.R.S. 1973)
13. Coordinates various state and local criminal justice programs providing services to local jails. (Office of Criminal Justice; 24-32-503, C.R.S. 1973)

Grants and Other Funds

14. Administers the Local Government Severance Tax Fund. (Division of Commerce and Development, Office of Impact Assistance; 32-29-110, C.R.S. 1973)
15. Administers the Local Government Mineral Impact Fund. (Division of Commerce and Development, Office of Impact Assistance; 34-63-102 (5) (a), C.R.S. 1973)
16. Administers the Oil Shale Trust Fund appropriations made from fiscal 1975 through fiscal 1981. (Division of Commerce and Development, Office of Impact Assistance; 39-63-104, C.R.S. 1973)
17. Accepts housing grants and services from the federal government and other sources and processes such grants and services for public and private non-profit agencies and corporations. (Division of Housing, Housing Development Section; 24-32-705, C.R.S. 1973)
18. Receives funding to implement various criminal justice programs and research studies. (Office of Criminal Justice, Director's Office; 24-32-503, C.R.S. 1973)

19. Receives federal funding for use by local and state agencies to implement juvenile justice programs. (Office of Criminal Justice, Juvenile Justice Section; 24-32-503, C.R.S. 1973)
20. Analyzes the fiscal need of applicants to the small communities sewer construction grant fund and recommends a level of financial assistance. (Division of Local Government, Local Government Services Section; 25-8-703, C.R.S. 1973)

Taxation Questions

21. Supervises the administration of all laws concerning the valuation and assessment of taxable property and the levying of property taxes. (Division of Property Taxation, State Board of Equalization and also Administration and Aid Assistance Sections; 39-9-106, C.R.S. 1973)
22. Intervenes in any court or tribunal proceeding regarding an abatement or refund of property taxes or a question bearing on statewide assessment policy. (Division of Property Taxation, Property Tax Administrator; 39-2-113, C.R.S. 1973)

Advisory Services

23. Chairs the State Impact Assistance Advisory Committee. (Office of Executive Director; 34-63-102, C.R.S. 1973)
24. Establishes reasonable standards for police training programs, training academies, and instructors, and establishes procedures for determining the qualifications of peace officers. (CLETA, Advisory Board; 24-32-605, C.R.S. 1973)
25. Serves in an advisory capacity to the state housing finance authority, and provides information on the housing needs of low and moderate income families in the state of Colorado. (Division of Housing, Housing Development Section; 24-32-705, C.R.S. 1973)
26. Reviews and approves manuals, appraisal procedures and instructions prepared and published by the Property Tax Administrator. (Division of Property Taxation, Advisory Board; 39-2-131, C.R.S. 1973)
27. Provides financial assessments and analyses for the State Impact Advisory Commission regarding all local governments requesting severance tax funds. (Division of Local Government, Local Government Services Section; 39-29-110, C.R.S. 1973)

Administers Programs of
Assistance to Local Governments

Funds Distribution

28. Distributes moneys from the state's severance tax fund in accordance with statutory purposes and established priorities. (Office of Executive Director; 39-29-110, C.R.S. 1973)
29. Administers all budget functions for the Colorado Law Enforcement Training Academy including coordination of expenditures with training and administrative units. (Colorado Law Enforcement Training Academy, Administration Section; 24-32-609, C.R.S. 1973)
30. Expends funds on behalf of the Colorado Law Enforcement Academy, including the receipts of gifts, legacies, and grants. (Colorado Law Enforcement Training Academy, Administration Section; 24-32-609, C.R.S. 1973)
31. Receives and reviews all local government budgets, determines the need for excess mill levies and provides technical assistance to local governments in preparation of budgets. (Division of Local Government, Local Government Services Section; 29-1-116, C.R.S. 1973)

Business Development

32. Provides site selection assistance to firms considering Colorado as a location for a new or expanding industry. (Division of Commerce and Development, Office of Business Development and Training; 24-32-303, C.R.S. 1973)
33. Assists new or expanding employers in securing training for potential employees. (Division of Commerce and Development, Office of Business Development and Training; 24-32-303, C.R.S. 1973)
34. Assists Colorado businesses in developing foreign markets for their goods and services. (Division of Commerce and Development, Office of Business Development and Training; 24-32-303, C.R.S. 1973)
35. Promotes the use of Colorado locations and services for motion picture and television films and television commercials. (Division of Commerce and Development, Motion Picture and Television Office; 24-32-309, C.R.S. 1973)
36. Advertises and publicizes the state of Colorado as a

tourist destination. (Division of Commerce and Development, Office of Tourism; 24-32-303 (2) (f) and 24-32-310, C.R.S. 1973)

37. Assists public and private agencies involved in planning and construction, or weatherization of existing housing by providing research and weatherization grants from appropriations made for this purpose. (Division of Housing, Weatherization Section; 24-32-705, C.R.S. 1973)
38. Develops and coordinates long range plans for state economic development. (Division of Commerce and Development, Office of Business Development and Training; 24-32-303 (2) (a), C.R.S. 1973)

Certification

39. Certifies peace officers pursuant to the rules and regulations provided by statute. (Colorado Law Enforcement Training Academy, Advisory Board; 24-32-605, C.R.S. 1973)
40. Performs such functions as are required by the peace officer standards and training statutes including the maintenance of all files and such records as necessary, issuing and administering documents related to officer certification, and administering the Peace Officers Standards and Training (P.O.S.T.) equivalency exam. (Colorado Law Enforcement Training Academy, P.O.S.T.; 24-32-609, C.R.S. 1973)
41. Inspects and approves camper trailers and camper coaches manufactured and sold within the state. (Division of Housing, Codes/Standards Section; 24-32-904, C.R.S. 1973)
42. Provides staff support and staff functions to the Voluntary Firefighter Certification Board, including scheduling examinations for firefighters throughout the state and certifying results of such exams. (Division of Local Government, Local Government Services Section; 24-32-1105, C.R.S. 1973)
43. Certifies to the State Board of Education valuations for assessment of all taxable property within each county and for each school district before November 5 of each year. (Division of Property Taxation, Administration Section; 22-50-109 (1), C.R.S. 1973)

Enforcement

44. Assists police agencies in the investigation of crime and in the enforcement of criminal laws. (Colorado Bureau of Investigation, Investigation Section; 24-32-412, C.R.S. 1973)
45. Detects and investigates organized crime activity transcending local jurisdictional boundaries. (Colorado Bureau of Investigation, Investigation Section; 24-32-412, C.R.S. 1973)
46. Regulates land use activities which may constitute a serious danger to public health, safety and welfare. (Division of Local Government, Land Use Commission; 24-65-104, C.R.S. 1982)
47. Investigates suspected criminal activity when directed to do so by the governor. (Colorado Bureau of Investigation, Chief's Office; 24-32-412 (1) (d), C.R.S. 1973)
48. Enters into and performs contracts with the Department of Social Services for the investigation of any matters arising under desertion or nonsupport laws of Colorado or a substantially similar enactment of another state. (Colorado Bureau of Investigation, Chief's Office; 24-32-412 (1) (f), C.R.S. 1973)
49. Investigates and assists in the prosecution of medicaid fraud and patient abuse as authorized by the federal "Medicare-Medicaid Anti-Fraud and Abuse Amendments." (Colorado Bureau of Investigation, Chief's Office; 24-32-412 (1) (g) (1), C.R.S. 1973)

Hearings

Property Tax

50. Hears appeals on orders and decisions of the State Property Tax Administrator. (Office of Executive Director, Board of Assessment Appeals; 39-2-125, C.R.S. 1973)
51. Hears appeals on orders and decisions of county boards of equalization. (Office of Executive Director, Board of Assessment Appeals; 39-2-125, C.R.S. 1973)
52. Conducts hearings upon complaints filed by the State Property Tax Administrator, upon the administrator's own motion or upon petition by any tax-levying authority in the state concerning valuations for assessment of property or concerning alleged dereliction of duty on the part of a

county assessor. (Office of Executive Director, Board of Assessment Appeals; 39-2-125, C.R.S. 1973)

53. Hears appeals from determinations by county assessors when a county board of equalization or an assessor has failed to respond within the time provided by statute to an appeal filed by a taxpayer. (Office of Executive Director, Board of Assessment Appeals; 39-2-125, C.R.S. 1973)
54. Hears appeals from decisions of boards of county commissioners when a claim for refund or abatement of taxes is denied in full or in part, if the claim applies to taxes due and paid during the current or preceding year. (Office of Executive Director, Board of Assessment Appeals; 39-2-125, C.R.S. 1973)
55. Conducts a hearing on the Property Tax Administrator's petition for reappraisal; if the reappraisal is ordered the division works with the affected county in the reappraisal effort. (Division of Property Taxation, Aid and Assistance Section and also Research and Development; 39-2-114, C.R.S. 1973)
56. Hears objections to public utility valuations by public utility companies, county assessors, or boards of county commissioners. (Division of Property Taxation, Utilities and Natural Resources Section; 39-4-107, 39-4-108, C.R.S. 1973)

Estate Tax

57. Hears appeals brought by the executive director of the Department of Revenue under section 39-23-142 (8), concerning estate taxes. (Office of Executive Director, Board of Assessment Appeals; 39-2-125, C.R.S. 1973)

Land Use

58. Conducts public hearings on proposed land use planning programs in each planning region of the state. (Division of Local Government, Land Use Commission; 24-65-104, C.R.S. 1973)

Housing Program Support

59. Encourages private enterprise and all public agencies engaged in the planning, construction, and acquisition of adequate housing or the rehabilitation of existing housing in Colorado by providing research, advisory, and liaison services and rehabilitation, construction, and acquisition

grants from appropriations made by the general assembly. (Division of Housing, Housing Development Grants Section; 24-32-705, C.R.S. 1973)

60. Assists local communities in the development and operation of local housing authorities. (Division of Housing, Housing Development Section; 24-32-705, C.R.S. 1973)
61. Encourages and promotes cooperation among counties and municipalities to jointly establish and operate housing authorities. (Division of Housing, Housing Development Section; 24-32-705, C.R.S. 1973)
62. Recommends and approves plans for relocation of individuals displaced in the acquisition of property by state agencies receiving federal funding to implement programs or projects. (Division of Housing, Housing Development Section; 24-56-107, C.R.S. 1973)

Information Services

Automated Data Processing

63. Provides oversight and coordination of the department's ADP activities. (Office of Executive Director, Accounting and Budgeting; 24-1-125, C.R.S. 1973)
64. Provides a comprehensive data base for the uniform statewide crime reporting program. (Colorado Bureau of Investigation, Administration of Justice Computer Center; 24-32-412, C.R.S. 1973)
65. Provides ADP data processing support for the Department of Corrections. (Colorado Bureau of Investigation, Administration of Justice Computer Center; 24-32-412, C.R.S. 1973)
66. Prepares, maintains, and interprets population estimates, population projections and data pertaining to demographic trends within the state. (Division of Local Government, Demography Section; 24-32-204, C.R.S. 1973)
67. Maintains an automated census mapping system for the purpose of developing a standardized geographic information system. (Division of Local Government, Demography Section; Executive Order, July 27, 1974)
68. Reviews all county, municipality, and certain special district audits; maintains a data base for all local government financial data; and publishes the Local Government Financial Compendium. (Division of Local Government, Local Government Services Section; 29-1-505, C.R.S. 1973)

69. Administers a program for collecting, analyzing, and disseminating statewide criminal justice statistics. (Office of Criminal Justice, Statistical Analysis Center; 24-32-503, C.R.S. 1973)
70. Maintains and updates a statewide criminal court data base. (Office of Criminal Justice, Statistical Analysis Center; 24-32-503, C.R.S. 1973)

Criminal Justice

71. Identifies arrested persons by fingerprint examination, and maintains files for the identification of criminals and stolen property. (Colorado Bureau of Investigation, Crime Information Section; 24-32-412, C.R.S. 1973)
72. Coordinates the development and use of related statewide criminal justice information and communication systems with similar programs nationwide. (Colorado Bureau of Investigation, Crime Information Section; 24-32-412, C.R.S. 1973)
73. Ensures that the juvenile justice system receives information concerning the most recent practices and approaches to delinquency control and other juvenile related problems. (Office of Criminal Justice, Juvenile Justice Section; 24-32-503, C.R.S. 1973)
74. Procures any records furnished by any law enforcement agency of the state of Colorado, including local law enforcement agencies, at the bureau's expense. (Colorado Bureau of Investigation, Chief's Office; 24-32-412 (1) (e), C.R.S. 1973)

Local Government

75. Files certificates of incorporation for all municipalities in the state. (Division of Local Government, Local Government Services Section; 24-32-110, C.R.S. 1973)
76. Acts as a central depository of local government information including election results, organization papers, inclusions and exclusions of land, dissolution papers and local government budgets. (Division of Local Government, Local Government Services Section; 32-1-Parts 1, 3, 8 and 9, C.R.S. 1973)
77. Approves all forms, notices, and schedules which are mailed by county assessors to taxpayers and approves internal documents such as maps, field books, plat and block books, and appraisal cards. (Division of Property Taxation, Research and Development Section; 39-2-109 and 39-5-107, C.R.S. 1973)

78. Prepares and distributes the special district election code to all special districts and provides simplified election instructions to all special districts. (Division of Local Government, Local Government Services Section; 32-1-806, C.R.S. 1973)

Energy Conservation

79. Provides information needed by a person who applies for or obtains a permit to build his own home to correlate the R-values to the U-values of the more energy conserving performance standards. (Division of Housing, Codes/Standards Section; 24-32-705, C.R.S. 1973)

Reports

80. Submits a report to the State Board of Equalization each September listing the assessed valuations in counties by class and subclass. (Division of Property Taxation, Administration Section; 39-5-124 and 39-2-115, C.R.S. 1973)
81. Publishes an annual report reflecting the valuation for assessment of all classes and subclasses of property, the levies imposed by each taxing jurisdiction, and the revenues for each jurisdiction. (Division of Property Taxation, Administration Section; 39-2-119, C.R.S. 1973)
82. Accepts from the county commissioners reports which certify the levies of each taxing jurisdiction. (Division of Property Taxation, Administration Section; 39-1-111, C.R.S. 1973)
83. Publishes manuals and various procedures and instructions, approved by the advisory board to the property tax administrator and subject to legislative review, which enable the county assessors to implement Colorado property tax statutes in their counties. (Division of Property Taxation, Research and Development Section; 39-2-109 and 42-3-106, C.R.S. 1973)
84. Submits annually to the general assembly a brief resume of the prior year's activities of the academy. (Colorado Law Enforcement Training Academy, Director's Office; 24-32-609 (1) (g), C.R.S. 1973)

Property Values

85. Determines the actual value of public utilities and rail transportation property and plant operations as a unit. (Division of Property Taxation, Utilities and Natural Resources Section; 39-4-102, 39-4.1-103, and 39-2-109, C.R.S. 1973)
86. Allocates a portion of the total value of public utilities and rail transportation property and plant operations to Colorado and apportions Colorado value among the counties within the state. (Division of Property Taxation, Utilities and Natural Resources Section; 39-4-106, 39-4-107, and 39-4.1-103, C.R.S. 1973)

Research and Evaluation

Housing

87. Conducts continuing research into new approaches to housing throughout the state including programs for low-income housing designed to discourage concentration in urban centers. (Division of Housing, Housing Development Section; 24-32-705, C.R.S. 1973)
88. Investigates living, dwelling, and housing conditions in the state and the means and methods of correcting unsafe, unsanitary, or substandard housing conditions. (Division of Housing, Housing Development Section; 24-32-705, C.R.S. 1973)
89. Conducts investigations and makes surveys on buildings or property. (Division of Housing, Housing Development Section; 24-32-705, C.R.S. 1973)

Law Enforcement

90. Establishes standards and adopts rules and regulations concerning the admission and training of law enforcement personnel. (Colorado Law Enforcement Training Academy, Training Section; 24-32-609, C.R.S. 1973)
91. Performs research, course development and the delivery of curricula related to the legal aspects of peace officer training. (Colorado Law Enforcement Training Academy, Training Section; 24-32-609, C.R.S. 1973)
92. Researches, develops, and produces audio-visual instructional media in cooperation with various academy instructors and administers media library and related

equipment. (Colorado Law Enforcement Training Academy, Training Section; 24-32-609, C.R.S. 1973)

93. Researches, updates and develops training courses. (Colorado Law Enforcement Training Academy, Training Section; 24-32-609, C.R.S. 1973)

Property Tax

94. Reviews all petitions for abatement or refund of property taxes to ensure conformity with the law. (Division of Property Taxation, Administration Section; 39-1-113 and 39-2-116, C.R.S. 1973)
95. Determines exemption of real and personal property from property taxation for religious institutions, private schools, and charitable purposes. (Division of Property Taxation, Exemption Section; 39-2-117 and Title 39, Article 3, C.R.S. 1973)
96. Examines complaints filed by a taxing jurisdiction or a taxpayer regarding the appraisal of a class or subclass, or alleging that property tax laws have been evaded or violated within their county. (Division of Property Taxation, Research and Development, and Aid and Assistance Sections; 39-2-111 and 39-2-112, C.R.S. 1973)
97. Reviews the abstracts of assessment, the decisions of the Board of Assessment Appeals, and the recommendations of the Property Tax Administrator. (Division of Property Taxation, Administration Section and also the State Board of Equalization; 39-2-109 and Title 39, Article 9, C.R.S. 1973)

Rules, Regulations, and Standards

98. Administers uniform construction and maintenance standards for factory-built housing and, where no standards exist, for hotels, motels, and multiple dwellings. (Division of Housing, Codes/Standards Section; 24-32-705 and 24-32-707, C.R.S. 1973)
99. Establishes rules and regulations concerning equipment of camper trailers and camper coaches to ensure their safety. (Division of Housing, Codes/Standards Section; 24-32-901, C.R.S. 1973)
100. Establishes guidelines for maps within a county assessor's office to ensure uniformity throughout the state. (Division of Property Taxation, Research and Development Section; 24-5-103.5, C.R.S. 1973)

Provides Technical Assistance
to Local Governments

Community Development

101. Provides technical assistance to rural communities interested in revitalizing their downtown areas. (Division of Commerce and Development, Office of Rural Development; 24-32-303 and 24-32-803, C.R.S. 1973)
102. Provides technical assistance to communities interested in encouraging economic development. (Division of Commerce and Development, Office of Business Development and Training; 24-32-303, C.R.S. 1973)
103. Provides technical assistance to communities interested in promoting tourism development. (Division of Commerce and Development, Office of Tourism; 24-32-303 (2) (e), C.R.S. 1973)

Land Use

104. Provides planning assistance to local governments in preparation and adoption of locally coordinated land use management systems for community development. (Division of Local Government, Planning Section; 24-32-203, C.R.S. 1973)
105. Assists in the development of land use programs for state and local governments. (Division of Local Government, Planning Section; 24-65-101, C.R.S. 1973)
106. Monitors local government compliance with laws governing subdivision of land. (Division of Local Government, Planning Section; 30-28-133, C.R.S. 1973)
107. Assists local governments in land use financing, planning, grants administration and management. (Division of Local Government, Planning Section; 24-32-104, C.R.S. 1973)

Law Enforcement

108. Assists district attorneys in preparing for prosecution cases in which the Colorado Bureau of Investigation has participated. (Colorado Bureau of Investigation, Investigation Section; 24-32-412, C.R.S. 1973)
109. Provides local law enforcement agencies with expertise in the examination and analysis of physical evidence. (Colorado Bureau of Investigation, Investigation and Administration Sections; 24-32-412, C.R.S. 1973)

110. Provides scientific laboratory services and facilities for assistance to law enforcement agencies in the examination of physical evidence. (Colorado Bureau of Investigation, Laboratory Section; 24-32-412, C.R.S. 1973)
111. Coordinates the statewide crime prevention program and assists local governments in their involvement. (Office of Criminal Justice, Associate Director; 24-32-503, C.R.S. 1973)
112. Analyzes systemwide criminal justice activities and problems. (Office of Criminal Justice, Associate Director; 24-32-503, C.R.S. 1973)
113. Analyzes problems facing local law enforcement agencies and provides alternative solutions for problem resolution. (Office of Criminal Justice, Associate Director; 24-32-503, C.R.S. 1973)

Property Taxation

114. Assists and cooperates in the administration of all laws concerning the valuation and assessment of taxable property and the levying of property taxes. (Division of Property Taxation, Aid and Assistance Section; 39-2-109, C.R.S. 1973)

Other Local Government Operations

115. Provides training and technical assistance to counties and municipalities which have building codes for the development of energy efficiency construction and renovation performance standards, including weatherization activities. (Division of Housing, Codes/Standards Section; 24-32-705, C.R.S. 1973)
116. Manages mapping functions of the state and assists local governments in land use planning activities requiring mapping. (Division of Local Government, Planning Section; 24-32-203, C.R.S. 1973; Executive Order, July 27, 1974)
117. Assists local governments in purchasing and develops specifications for and handles bid openings. (Division of Local Government, Local Government Services Section; 24-32-104, C.R.S. 1973)
118. Provides technical assistance in defining local government problems and developing solutions. (Division of Local Government, Local Government Services Section; 24-32-104, C.R.S. 1973)

Provides Training to Local Government Officials

Assessors

119. Operates an annual school for assessors to enhance their knowledge of appraisal and valuation procedures. (Division of Property Taxation, Aid and Assistance and Education Sections; 39-2-110, C.R.S. 1973)

Law Enforcement

120. Administers training functions of the Colorado Law Enforcement Training Academy. (Colorado Law Enforcement Training Academy, Training Section; 24-32-609, C.R.S. 1973)
121. Coordinates the State Patrol's basic schedule of instruction. (Colorado Law Enforcement Training Academy, Training Section; 24-32-609, C.R.S. 1973)
122. Provides in-service and refresher training to law enforcement personnel throughout the state. (Colorado Law Enforcement Training Academy, Training Section; 24-32-609, C.R.S. 1973)

Department Totals:

\$8,640 K-G
 \$3,454 K-F
 \$23,748 K-C
 \$1,426 K-G,C
 \$1,460 K-G, HUTF

232.3 FTE

DEPARTMENT OF LOCAL AFFAIRS

LA-16

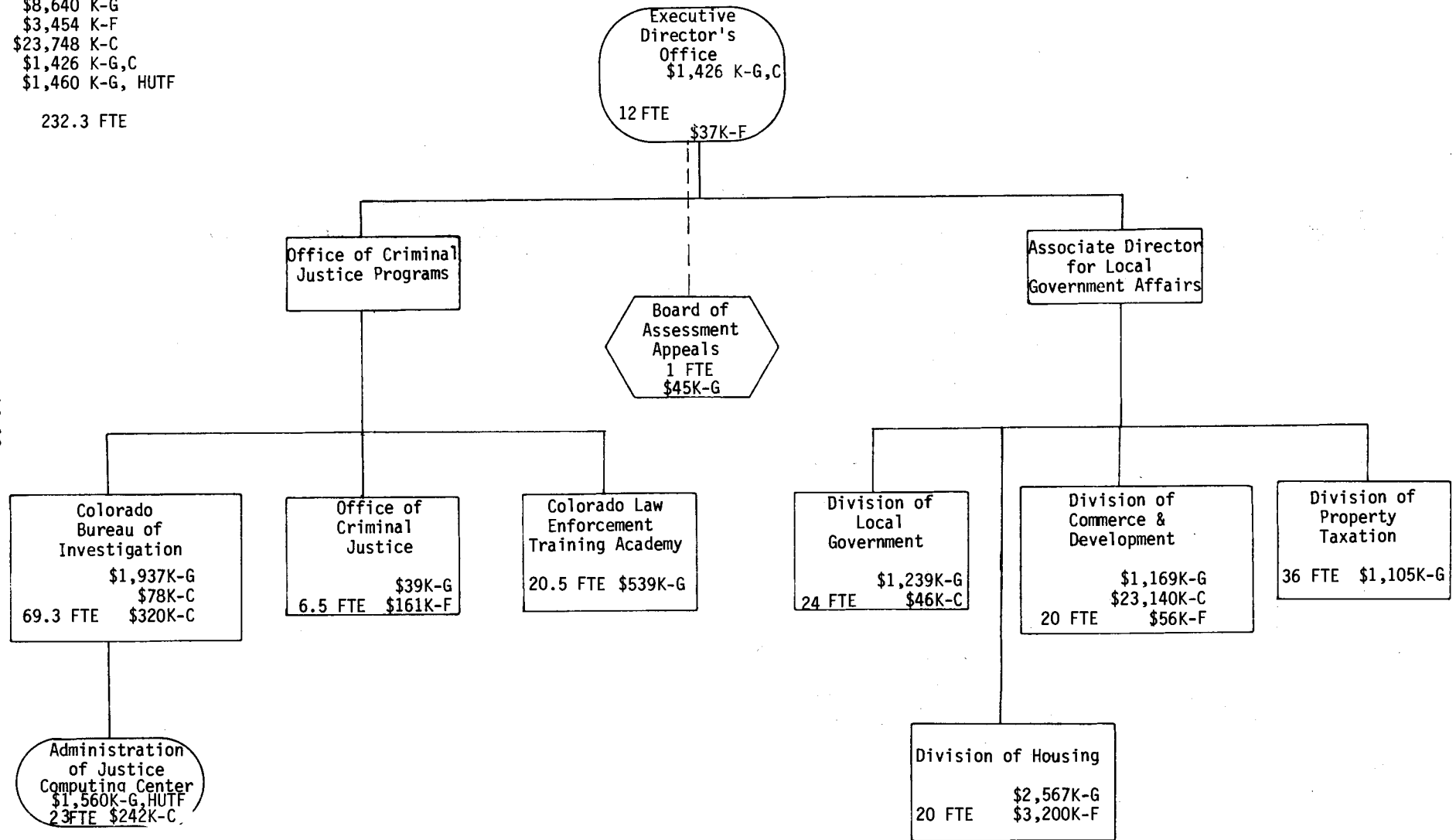

Office Totals: \$1,508

\$45 K-G*
\$37K-F*
\$1,426K-G,C

13 FTE

OFFICE OF THE EXECUTIVE DIRECTOR

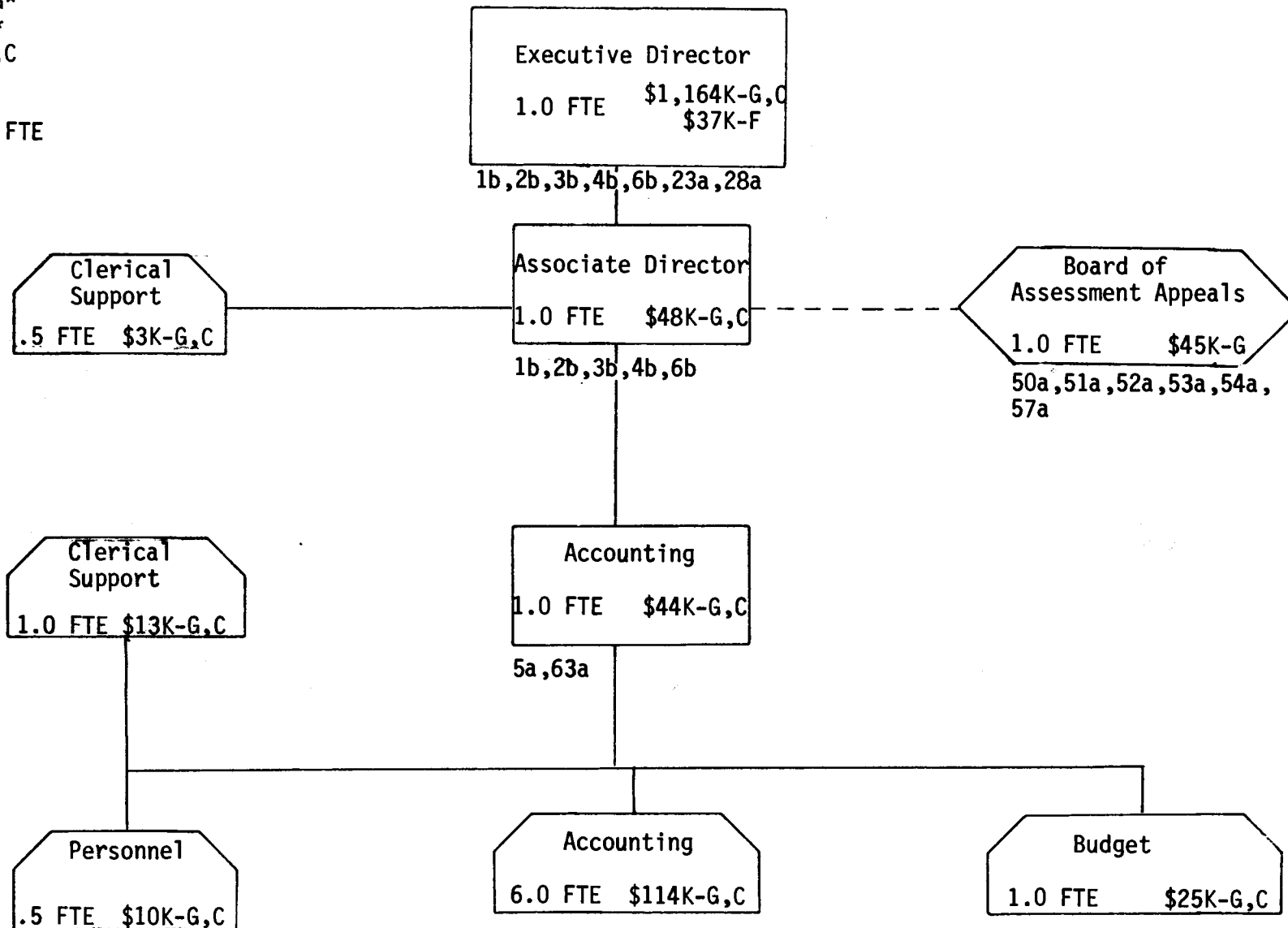

LA-17

* Incl. Per. Ser., Operating & Travel Exp. for the Office of the Executive Director (\$313,765); Capital Outlay & Legal Services for the Department (\$148,744) and the appropriation for Denver Cultural Facilities (\$1,000,000,000).

COLORADO BUREAU OF INVESTIGATION

Bureau Totals: \$3,717

\$1,937K-G
 \$1,460K-G, HUTF
 \$320K-C

92.3 FTE

Office of the Chief
 47a,48a,49a,74a

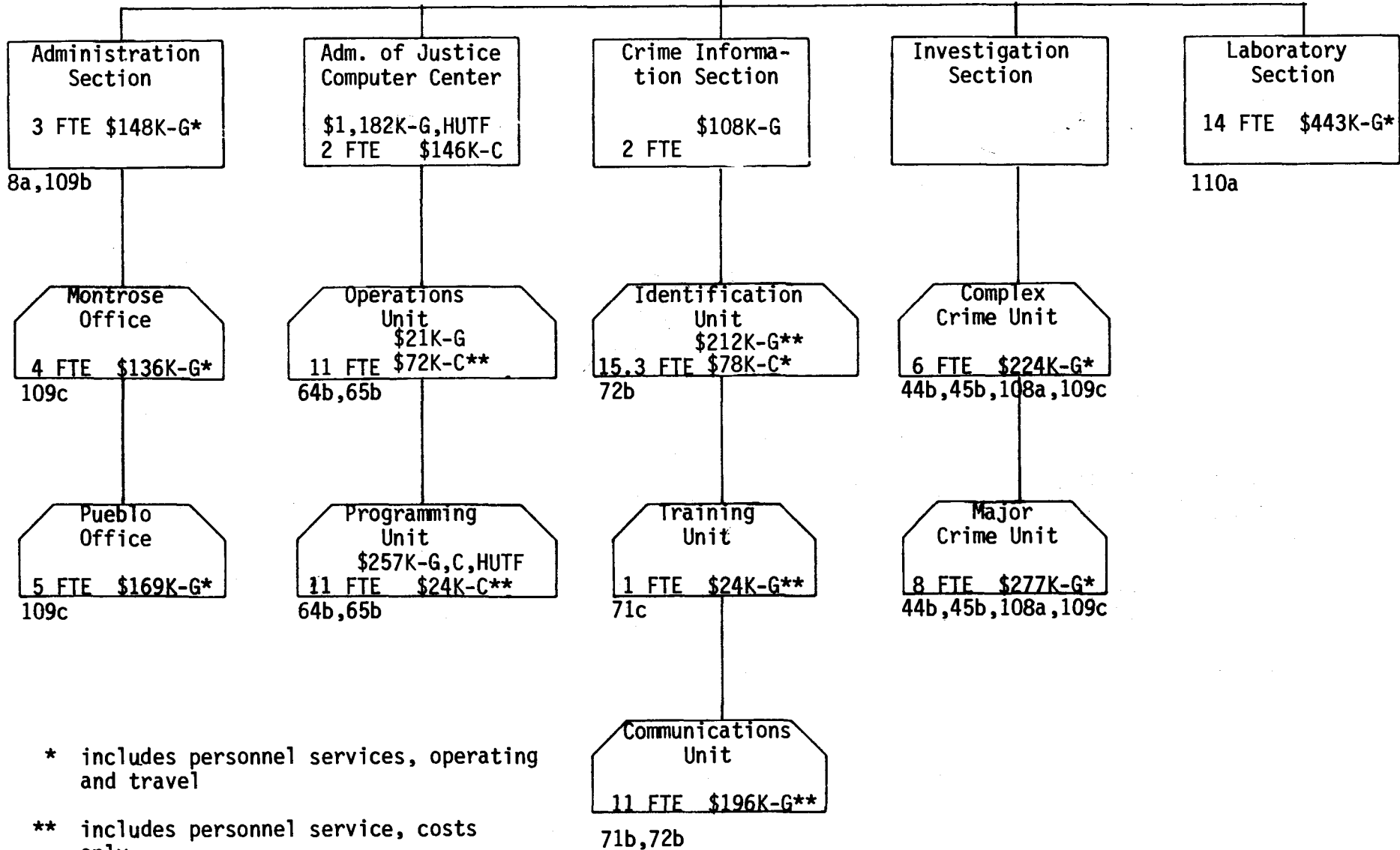

LA-18

* includes personnel services, operating and travel

** includes personnel service, costs only

Division Totals:

\$1,169 K-G
 \$16 K-F
 \$23,140 K-C
 20 FTE

DIVISION OF COMMERCE AND DEVELOPMENT

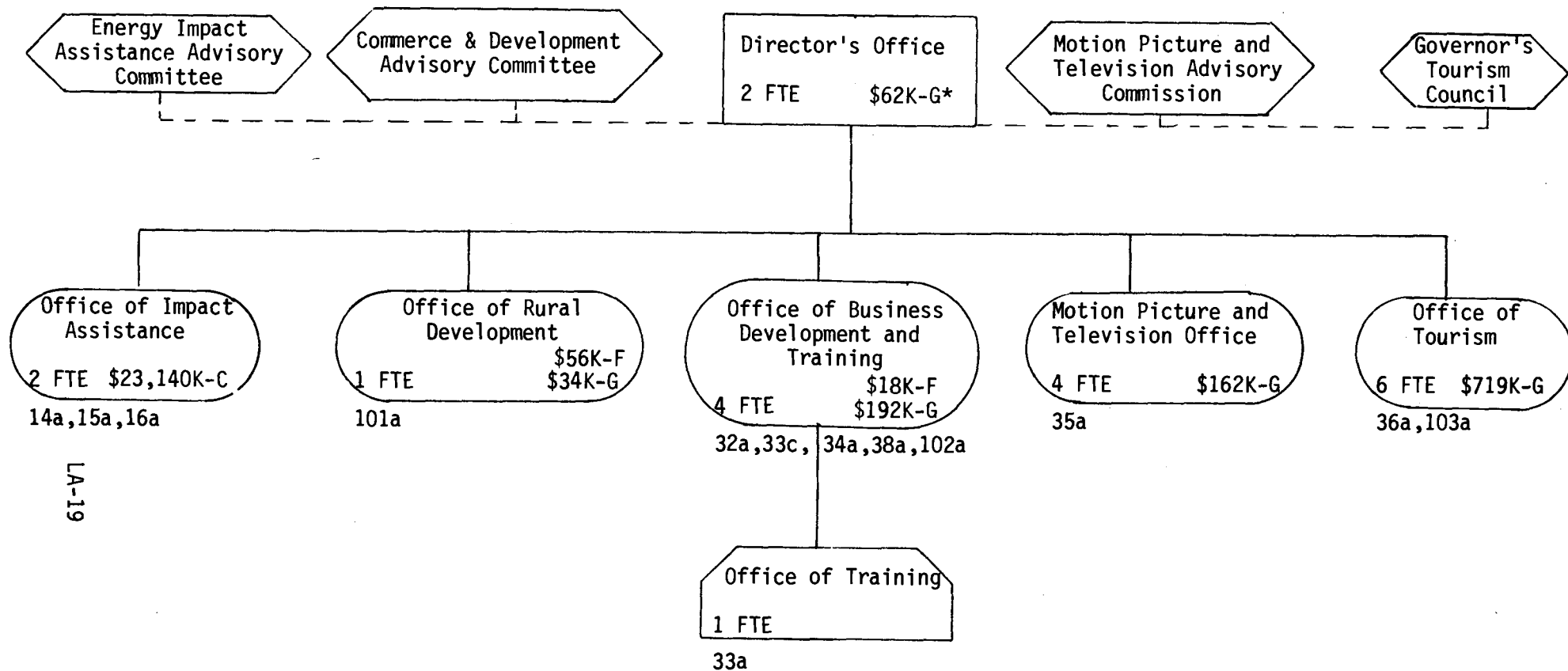

LA-19

* Incl. Per. Ser., Operating & Travel Exp. for division director, Office of Rural Development, Office of Business Development and Training, Office of Training and Office of Tourism.

Office Totals:

\$39 K-G

\$161 K-F

6.5 FTE

OFFICE OF CRIMINAL JUSTICE

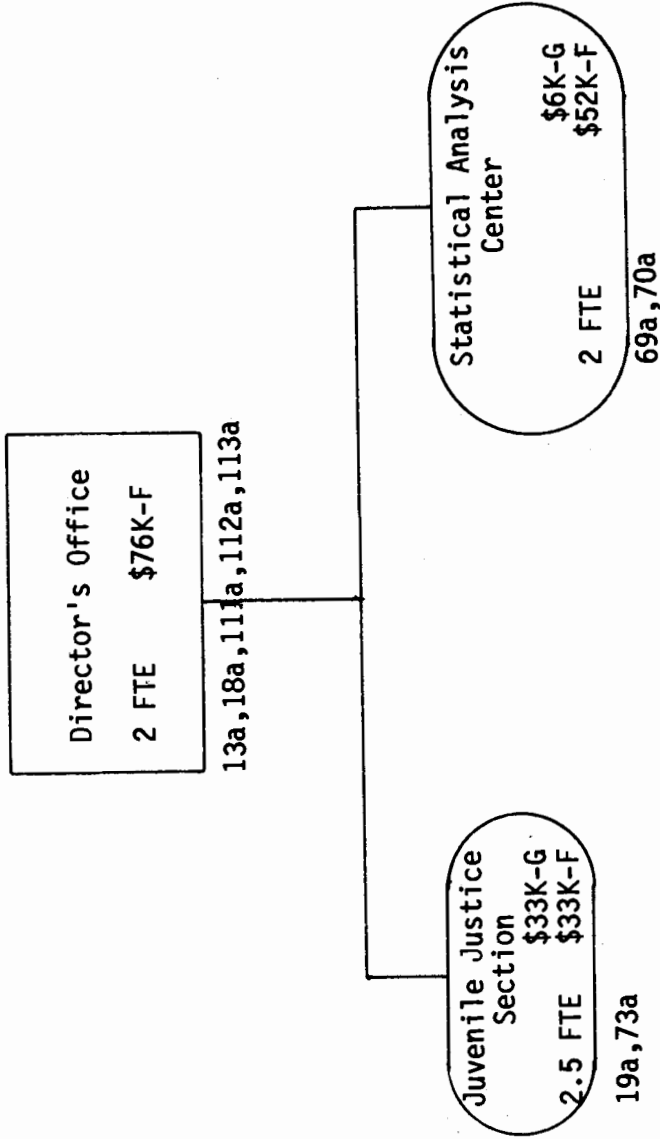

Division Totals:

\$2,567 K-G
\$3,200 K-F

20 FTE *

DIVISION OF HOUSING

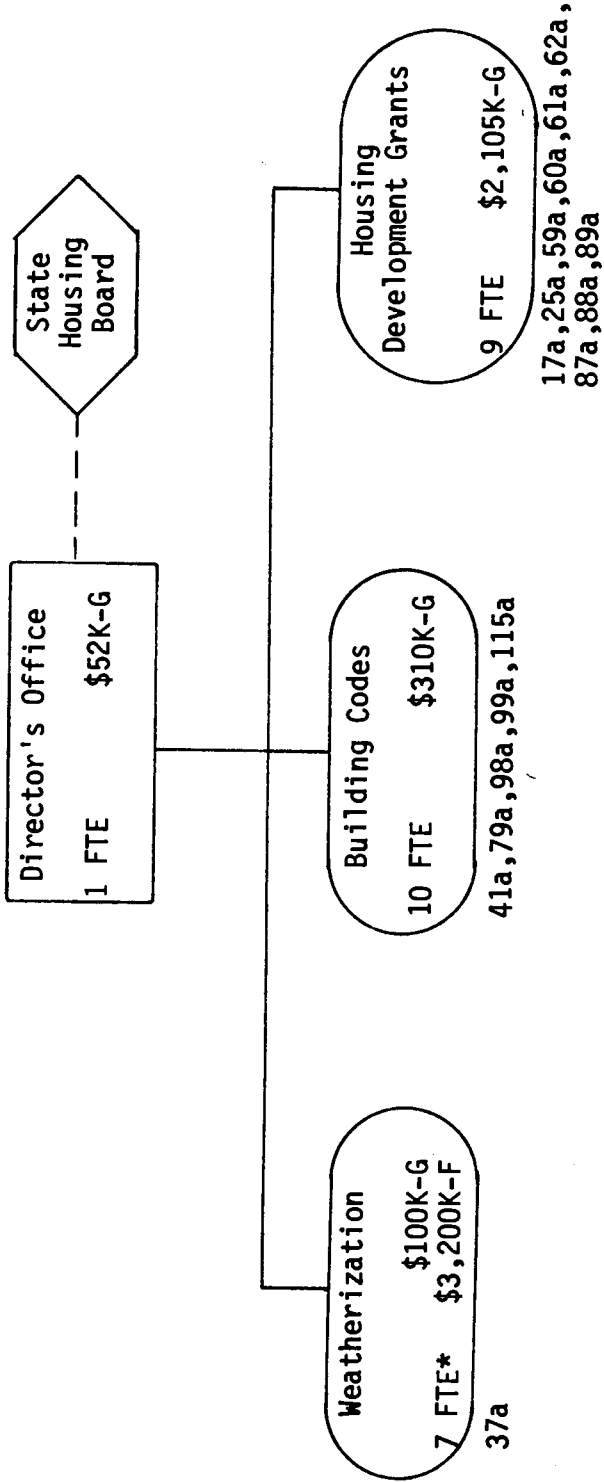

* 7FTE paid with federal funds.

COLORADO LAW ENFORCEMENT TRAINING ACADEMY

Totals:

\$539 K-G

20.5 FTE *

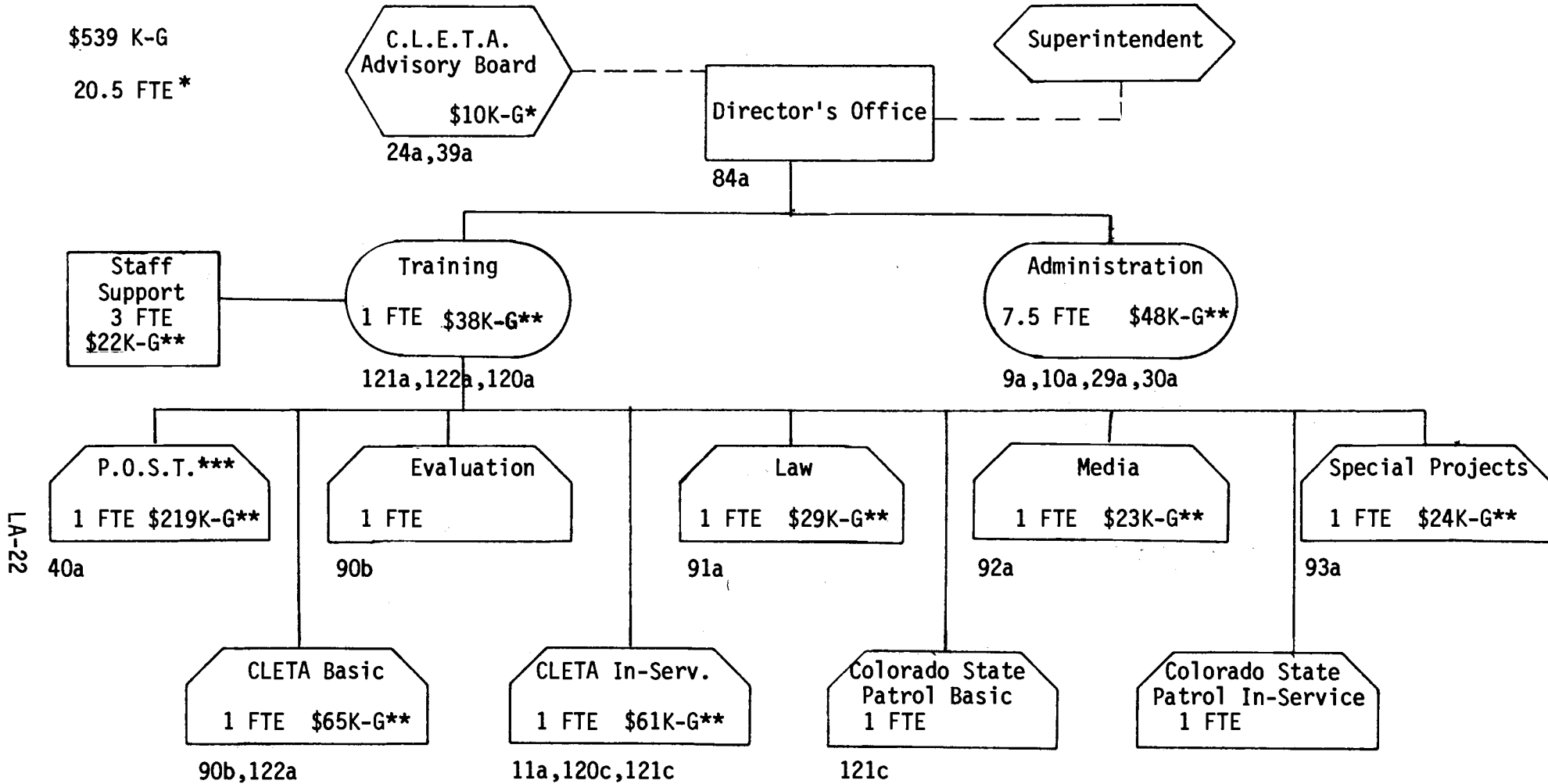

LA-22

* 11.0 FTE for Dept. of Local Affairs; 9.5 FTE State Patrol

** Dollar amounts for Dept. of Local Affairs only

*** Peace Officers Standards and Training

Division Totals:

\$1,239 K-G
 \$46 K-C
 24 FTE

DIVISION OF LOCAL GOVERNMENT

LA-23

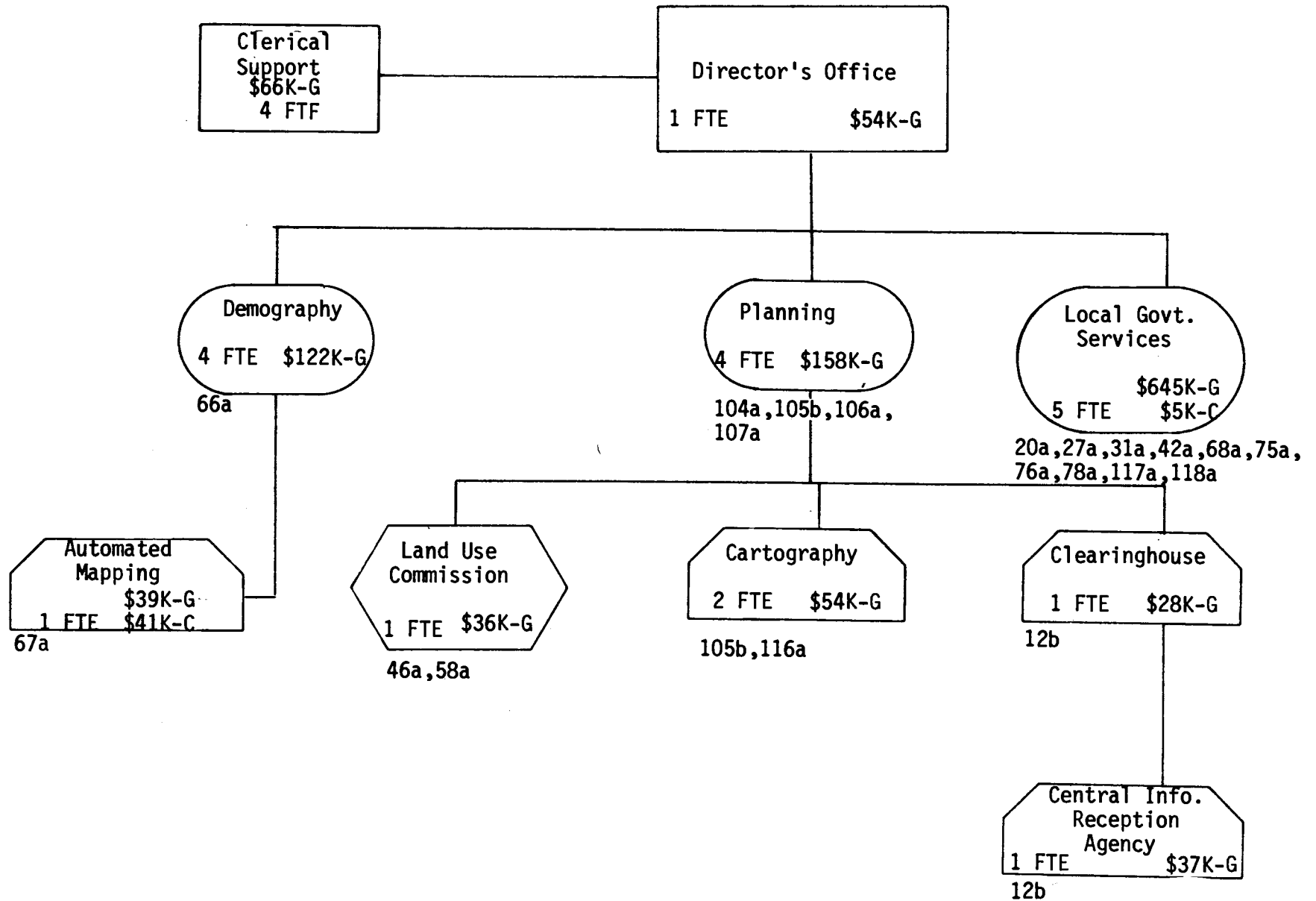

Division Totals:

\$1,105 K-G

36 FTE

DIVISION OF PROPERTY TAXATION

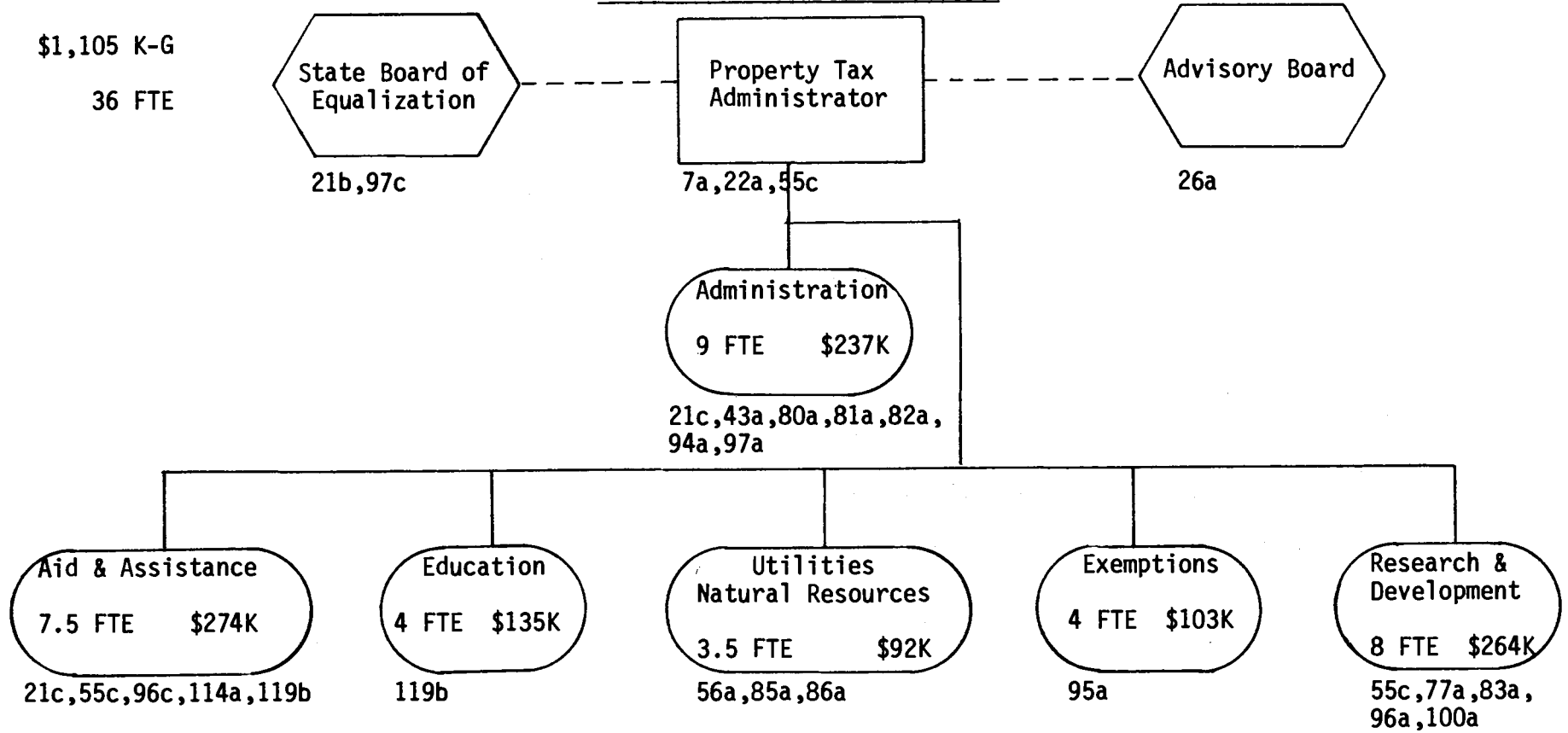

LA-24

DEPARTMENT OF MILITARY AFFAIRS

Provides Internal Security and Response
to Emergencies for the State

	<u>Page</u>
Disaster Planning.....	MA-1
Emergency and Security Services.....	MA-2
Management and Administration.....	MA-2
Property and Equipment Maintenance.....	MA-3
Training.....	MA-3

DEPARTMENT OF MILITARY AFFAIRS

Provides Internal Security and Response to
Emergencies for the State

Disaster Planning

1. Prepares and maintains a state disaster plan which includes an identification of areas vulnerable to disasters and recommendations for zoning, building and a plan for the prevention and minimization of injury and damage caused by disasters. (Division of Disaster Emergency Services, Disaster Planning Section; 28-2-105, C.R.S. 1973)
2. Assists in the development and revision of local and interjurisdictional disaster plans including the promulgation of standards and requirements for such plans. (Division of Disaster Emergency Services, Nuclear Civil Protection Section and Disaster Planning Section; 28-2-107, C.R.S. 1973)
3. Coordinates the state disaster plan with the disaster plans of the federal government. (Division of Disaster Emergency Services, Office of the Director; 28-2-105, C.R.S. 1973)
4. Keeps apprised of the impact of weather modification on weather conditions which could present danger of precipitation or other climatic activity severe enough to constitute a disaster and advises the Department of Natural Resources of such an occurrence. (Division of Disaster Emergency Services, Operations Section and Disaster Planning Section; 28-2-114, C.R.S. 1973)
5. Coordinates the efforts of federal, state, local and private entities in the implementation of disaster plans. (Division of Disaster Emergency Services, Operations Section; 28-2-105, C.R.S. 1973)
6. Employs technical or professional personnel capable of providing expert assistance to political subdivisions. (Division of Disaster Emergency Services, Operations Section; 28-2-105 (2), C.R.S. 1973)
7. Conducts studies and adopts measures to reduce the impact of and actions contributing to a disaster. The studies concentrate on means of reducing or avoiding the dangers caused by disasters or the consequences thereof. (Division of Disaster Emergency Services, Operations Section and Disaster Planning Section; 28-2-110, C.R.S. 1973)
8. Establishes the rules and regulations which govern reimbursements to state agencies and political subdivisions

from disaster emergency funds. (Division of Disaster Emergency Services, Administrative Support Section; 28-2-106, C.R.S. 1973)

Emergency and Security Services

9. Serves at the direction of the governor to protect life and property and to preserve state internal security. (Division of National Guard, Army and Air National Guards; 28-3-105, C.R.S. 1973)
10. Conducts air search and rescue missions. (Division of Civil Air Patrol; 28-1-101, C.R.S. 1973)
11. Investigates and determines locations of emergency locator transmissions. (Division of Civil Air Patrol; 28-1-101, C.R.S. 1973)
12. Supports emergency operations in the state including air reconnaissance and communications. (Division of Civil Air Patrol; 28-1-101, C.R.S. 1973)
13. Acts as the organized military forces of the state of Colorado, in addition to and distinct from the national guard. (Division of State Guard; 28-4-104, C.R.S. 1973)

Management and Administration

14. Maintains custody of all military records, correspondence and other military documents. (Office of the Adjutant General, Budget and Fiscal Office, Administration and Personnel Services, and Division of Disaster Emergency Services, Operations Section; 23-3-106, C.R.S. 1973)
15. Causes to be prepared all necessary material to carry forth the provisions of the military code. (Office of the Adjutant General, Administration and Personnel Services Section; 28-3-106, C.R.S. 1973)
16. Administers the technician (full-time employee) force authorized by federal law (32 USC 702 (d)). (Office of the Adjutant General and Division of National Guard, Technical Personnel Office; no state statutory mandate)
17. Prescribes regulations, not inconsistent with law, that increase the efficiency and discipline of the national guard. (Office of the Adjutant General; 28-3-106 (10), C.R.S. 1973)

18. Manages Buckley Air National Guard Base. (Office of the Adjutant General and Division of National Guard, Colorado Air National Guard; no state statutory mandate)
19. Conducts internal review of programs of the National Guard. (Division of National Guard, U.S. Property and Fiscal Office; no state statutory mandate)
20. Provides centralized budget, accounting, personnel and administrative services to all elements of the Department of Military Affairs. (Office of the Adjutant General, Administration and Personnel Services; 24-1-134, C.R.S. 1973)

Property and Equipment Maintenance

21. Attends to the safekeeping and repairing of the ordinance, arms, equipment, and all other military property belonging to the state or issued to it by the United States. (Office of the Adjutant General, Facilities Office; 28-3-106, C.R.S. 1973; 32 USC 702 (d))
22. Acquires or disposes of real property required for use of the Department of Military Affairs. (Office of the Adjutant General; 28-3-106 (18), C.R.S. 1973)
23. Maintains and operates 101 buildings located in 25 separate locations. (Office of the Adjutant General, Facilities Office; 28-3-106 (17), C.R.S. 1973)
24. Examines and evaluates national guard use of federal equipment and expenditure of federal funds; stores and distributes such equipment. (Division of National Guard, U.S. Property and Fiscal Office; 32 USC 708)
25. Receives and accounts for all funds and property of the U.S. in the possession of the Colorado National Guard. (Division of National Guard, U.S. Property and Fiscal Office; 32 USC 708)

Training

26. Recruits, trains and maintains a force of trained and operationally ready units and individuals to serve as a (Division of National Guard, Army and Air National Guards; 32 USC)
27. Conducts military schools and training management programs, a civilian authorities program and a surface maintenance program. (Division of National Guard, Colorado Army National Guard; 32 USC 501)

28. Conducts training program for Air National Guard units in Colorado. (Division of National Guard, Colorado Air National Guard; no state statutory mandate)
29. Conducts a cadet training program in aerospace education, military leadership, physical fitness and moral leadership. (Division of Civil Air Patrol; 28-1-101, C.R.S. 1973)

Department Totals:

\$1,251 K-G
\$40 K-C
\$36,454 K-F

1,059 FTE

DEPARTMENT OF MILITARY AFFAIRS

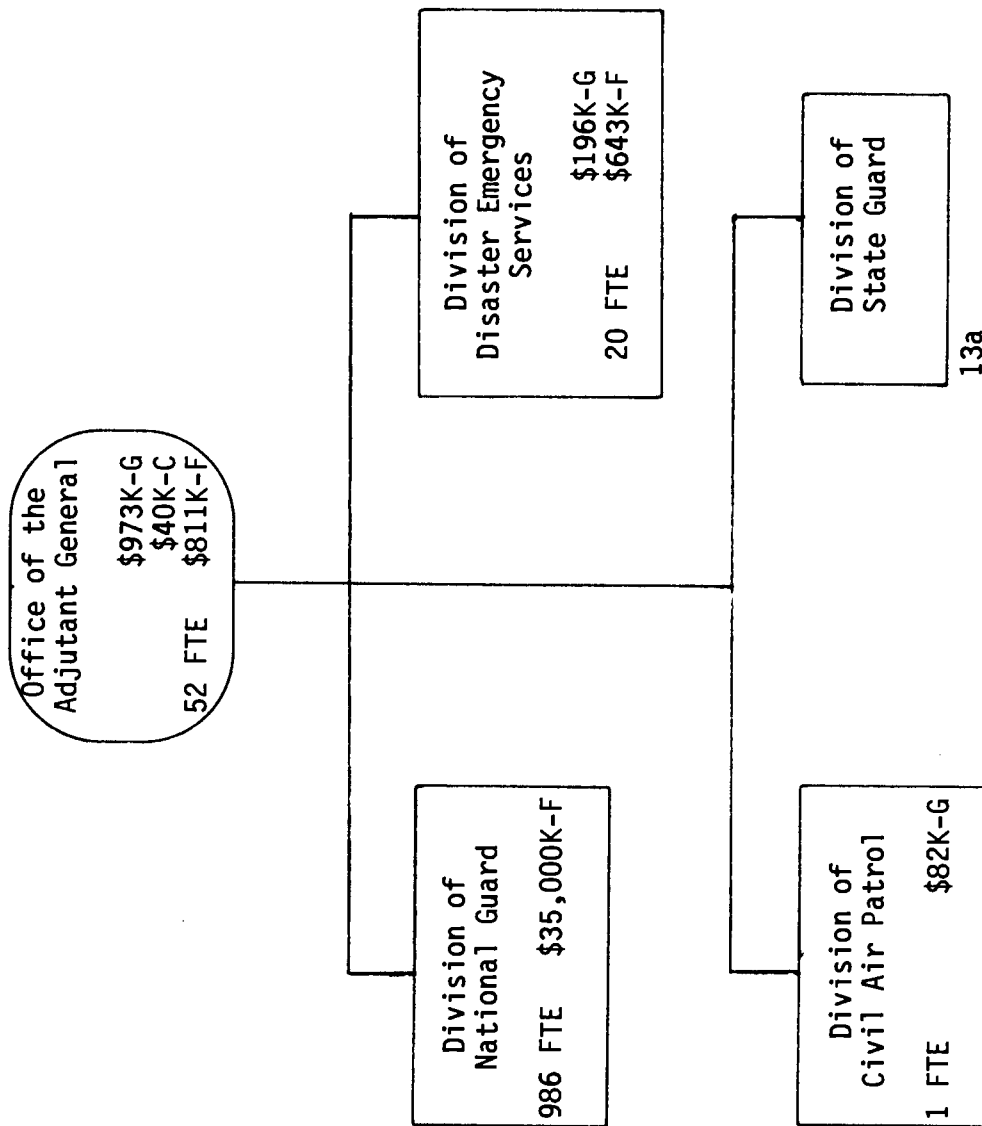

Office Totals:

\$973 K-G
\$40 K-C
\$80 K-F

26 FTE

OFFICE OF ADJUTANT GENERAL

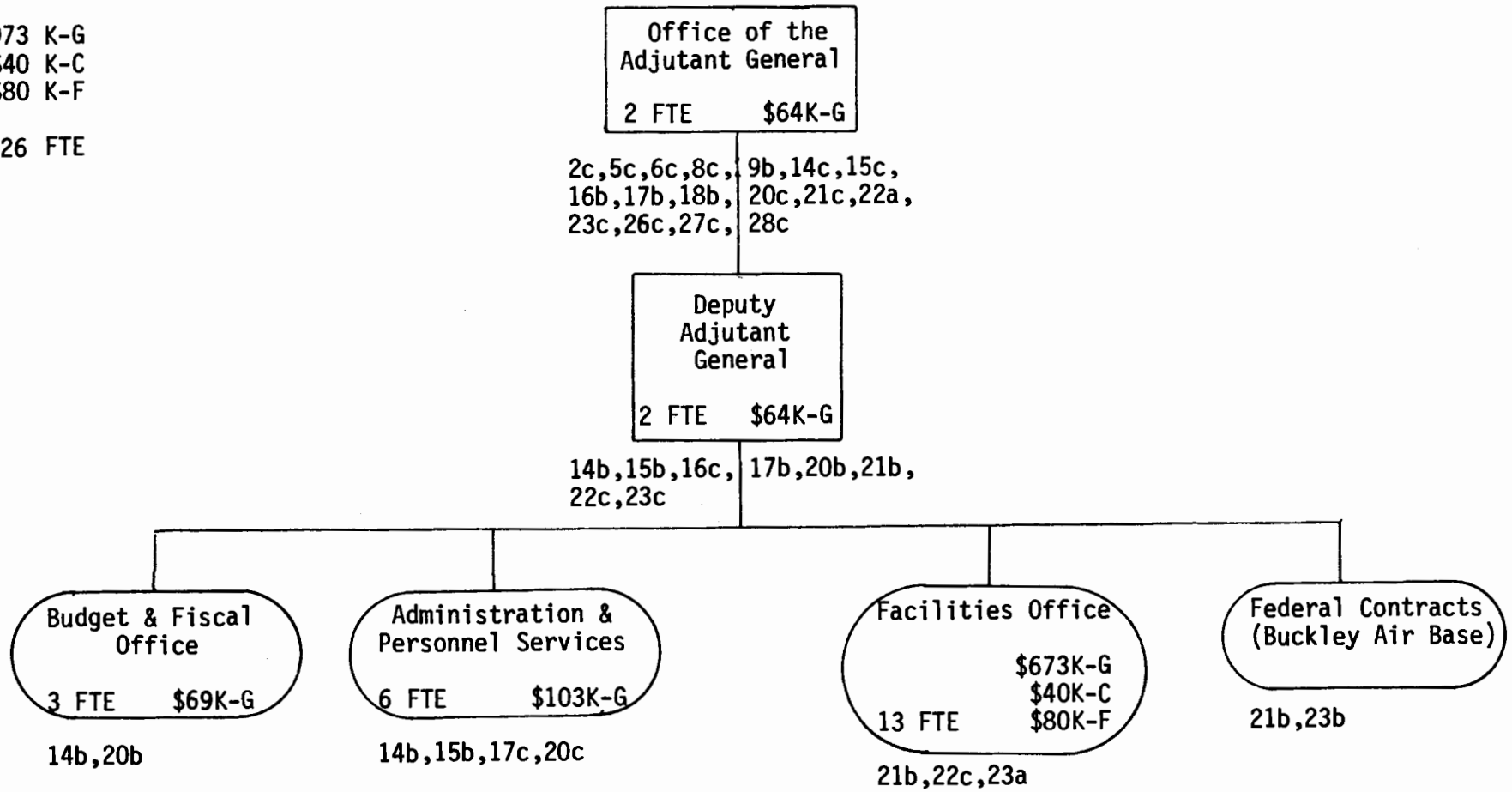

MA-6

Division Totals:

\$82 K-G

1 FTE

DIVISION OF CIVIL AIR PATROL

Colorado Wing
Commander

1 FTE \$82K-G

10a,11a,12a,29a

MA-7

DIVISION OF DISASTER EMERGENCY SERVICES

Division Totals:

\$587 K-F
 \$147 K-G
 20 FTE

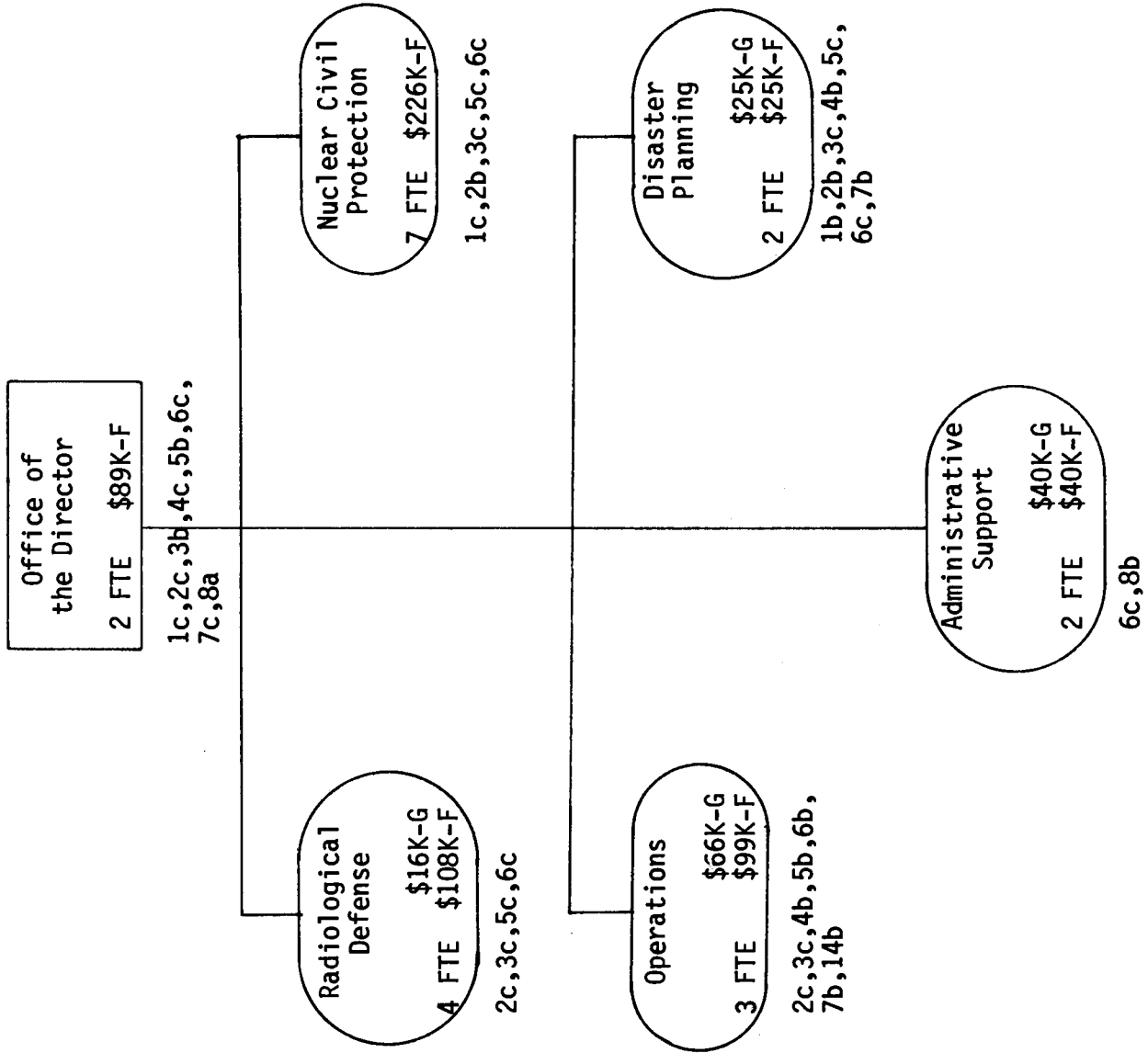

Division also administers \$367K federal funds which flow thru to local governments

DIVISION OF NATIONAL GUARD

Division Totals:

\$34,943 K-F

986 FTE

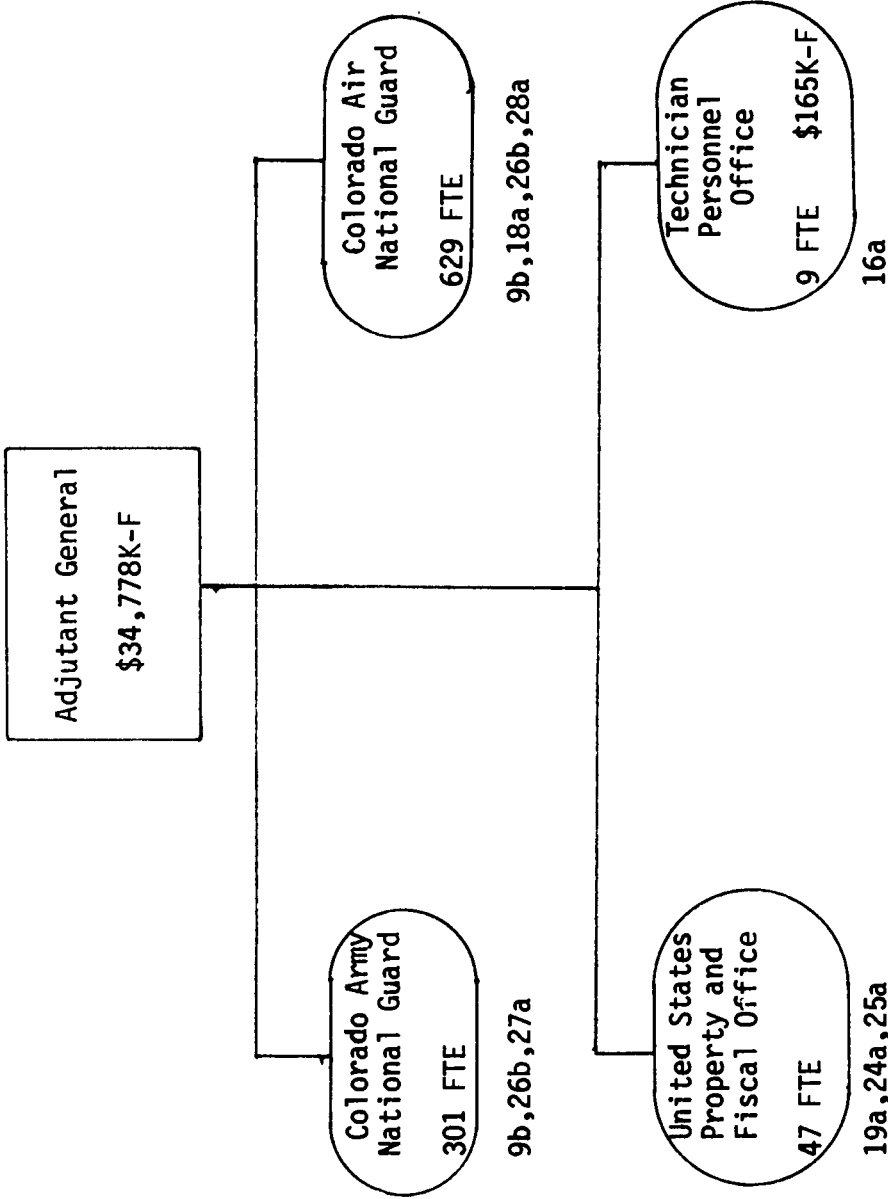

SOURCE OF FUNDING: \$34,778K federal funds
(disbursed by federal government)

DEPARTMENT OF NATURAL RESOURCES

	<u>Page</u>
<u>Acquires and Develops the State's Natural Resources and Allocates Revenues</u>	
Construction and Maintenance.....	NR-2
<u>Facilitates Intergovernmental Cooperation in Resource Development and Management</u>	
Federal-State Relations.....	NR-3
Resource Management.....	NR-3
State-Local Relations.....	NR-5
Resource Management.....	NR-5
<u>Preserves and Protects the State's Natural Resources</u>	
	NR-6
<u>Promotes Environmental Safety and Conducts Safety Inspections</u>	
	NR-8
<u>Provides Administrative and Management Services</u>	
Data Collection and Reporting.....	NR-10
Energy Development.....	NR-11
Land.....	NR-11
Minerals and Mining.....	NR-12
Water	NR-14
Enforcement.....	NR-15
Fees, Licenses and Permits.....	NR-16
Minerals.....	NR-16
Mining Operations.....	NR-17
Recreation.....	NR-17
Water Development.....	NR-18
Weather Modification.....	NR-19
Wildlife.....	NR-19
Hearings.....	NR-20
Internal Management and Support Services.....	NR-22
Resource Management.....	NR-23
Land, Minerals and Mining.....	NR-23
Recreation.....	NR-25
Water Development.....	NR-26
Wildlife.....	NR-28

DEPARTMENT OF NATURAL RESOURCES

Acquires and Develops the State's Natural Resources
and Allocates Revenues

1. Takes necessary steps to acquire from the state land board interests in land which has unique environmental or economic value and is likely to be sold to private parties. (Executive Director's Office; 24-33-107, C.R.S. 1973)
2. Promotes the economic development of mineral resources. (Colorado Geological Survey, Mineral Resources, Ground Water Investigations, Mineral Fuels Sections; 34-1-103 (1) (b), C.R.S. 1973)
3. Approves agreements for the development and operation of geothermal resources. (Oil and Gas Conservation Commission; 34-70-104 (2), C.R.S. 1973)
4. Directs the distribution of water from state reservoirs in times of water scarcity. (Division of Water Resources, State Engineer and Water Divisions; 37-88-108, and 109, C.R.S. 1973)
5. Appropriates and acquires for the state such water as may be required to preserve a natural environment. (Water Conservation Division, Hydrology Section; 37-92-102, C.R.S. 1973)
6. Sells state land at public auction but reserves mineral rights and rights-of-way to the land. (State Board of Land Commissioners, Land-Water Management Division; 36-1-122 and 125, C.R.S. 1973)
7. Leases state lands for an annual rent and also receives royalties for production of any minerals under lease. (State Board of Land Commissioners, Land-Water Management Section, and also Minerals Section; 36-1-113, C.R.S. 1973)
8. Leases state lands at a rate that produces optimum revenue to the state. (State Board of Land Commissioners, Land-Water Management Section and also Fiscal Accounting Section; 36-1-114 and 118 (1) (a), C.R.S. 1973)
9. Constructs or otherwise establishes facilities on land under its jurisdiction, operates and maintains such lands and facilities, provides services and charges fees. (Division of Parks and Outdoor Recreation, Planning and Development Unit; 33-30-105 (1) (c), C.R.S. 1973)
10. Leases state land for the exploration, production and development of geothermal resources. (State Board of Land Commissioners, Minerals Section; 36-1-147, C.R.S. 1973)

11. Advises state agencies on geothermal resources. (Colorado Geological Survey, Ground Water Investigations Section; 34-1-103 (1) (j), C.R.S. 1973)
12. Credits timber sales and rental payments on school lands and other trust lands to the proper income fund, and credits royalties for extraction of non-renewable resources to the proper permanent trust fund. (State Board of Land Commissioners, Land-Water Administration Section and Fiscal-Accounting Section; 36-1-116, C.R.S. 1973)
13. Preserves the state's waters for the use of the people of Colorado and prevents the unauthorized transport of the state's waters to other states. (Division of Water Resources, Water Divisions and State Engineer; 37-81-102, C.R.S. 1973)
14. Acquires interests in land or water and leases, exchanges or sells interests in land or water. (Division of Parks and Outdoor Recreation, Planning and Development Unit; 33-30-105 (1) (a) and (b), C.R.S. 1973)
15. Acquires interests in land or water and leases, exchanges, or sells interest in land or water as may be necessary for preservation of wildlife. (Division of Wildlife, Wildlife Commission; 33-1-112 (1) (a) and (b), C.R.S. 1973)
16. Acquires property and erects structures for soil conservation purposes. (State Soil Conservation Division; 35-70-103 (6) (f) and (g), C.R.S. 1973)

Construction and Maintenance

17. Enters into contracts for the construction of projects to conserve and utilize the state's water and power resources. (Water Conservation Division, Project Construction Section; 37-60-106 (1) (1), 37-60-119, 37-60-120, C.R.S. 1973)
18. Acts for the Colorado Water Resources and Power Development Authority as its agent in planning, construction, and maintenance of a project or may do feasibility studies for the authority. (Water Conservation Division, Project Construction and Planning Sections; 37-95-106 (1) (k) (II), 37-95-107 (3) (a), 37-95-116, C.R.S. 1973)
19. Undertakes studies of watershed planning and may undertake development of watershed flood prevention and underground water storage projects. (State Soil Conservation Division; 35-70-103 (6) (a), C.R.S. 1973)
20. Helps plan, establish, develop, operate, and maintain segments of national scenic trails. (Division of Parks and

~~Outdoor Recreation, Planning and Development Unit;
33-42-108 (4), C.R.S. 1973)~~

~~Facilitates Intergovernmental Cooperation in
Resource Development and Management~~

Federal-State Relations

Resource Management

21. Negotiates with the federal government in all resources and conservation matters. (~~Executive Director's Office; 24-33-103, C.R.S. 1973~~)
22. Grants rights-of-way onto state lands to governmental agencies and utilities. (~~State Board of Land Commissioners, Land-Water Management Section, Surface and Engineering Rights-of-Way Units, and Fiscal-Accounting Section, Surface Accounts Unit; 36-1-136, C.R.S. 1973~~)
23. Cooperates with the U.S. Forest Service and takes other measures to protect the state's timber land from fire destruction. (~~State Board of Land Commissioners, Land-Water Administration Section and Fiscal Accounting Section; 36-7-105, C.R.S. 1973~~)
24. Contracts with federal and other agencies to carry out Land and Water Conservation Fund purposes; maintains statewide plans for developing outdoor recreation resources; undertakes the development of such resources; and administers agreements with the U.S. on behalf of local governments. (~~Division of Parks and Outdoor Recreation, Planning and Development, and Grants Units; 33-2-108, C.R.S. 1973~~)
25. Designates a state recreational trails system and sets up a procedure to allow federal and state agencies, local governments, and private organizations to propose trails in the state system. (~~Division of Parks and Outdoor Recreation, Planning and Development Unit; 33-42-108 (1), (2), and (3), C.R.S. 1973~~)
26. Conducts and establishes cooperative wildlife restoration projects under the federal Pittman-Robertson Act. (~~Division of Wildlife, Ecological, Wildlife Services, Wildlife Research, Game, and Planning Sections, and also all Regional Offices; 33-2-104, C.R.S. 1973~~)
27. Conducts and establishes cooperative fish restoration and management projects under the federal Dingell-Johnson Act. (~~Division of Wildlife, Ecological, Wildlife Services and~~)

- Fish Research Sections, and also all Regional Offices;
33-2-105, C.R.S. 1973)
28. Acts as a liaison agency in transactions dealing with natural resources between state agencies and with other states and the federal government. (Colorado Geological Survey, Mineral Resources, Ground Water Investigations, Mineral Fuels, Engineering and Environmental Geology Sections; 34-1-103 (1) (a) and (f), C.R.S. 1973))
 29. Assists federal agencies with their preliminary water development surveys. (Water Conservation Division, Flood Plain Management and Planning Sections; 37-60-106 (1) (e) and (f), C.R.S. 1973))
 30. Investigates and helps formulate a response to plans, proposals and laws of the federal government and other states which might affect Colorado water and confers with and appears before agencies of the United States and other states to protect the water interests of Colorado. (Water Conservation Division, Hydrology and Planning Sections; 37-60-106 (1) (h) and (i), C.R.S. 1973))
 31. Exchanges state lands for unappropriated federal land. (State Board of Land Commissioners, Land-Water Management Section; 36-1-141, C.R.S. 1973))
 32. Enters into cooperative agreements with any federal agency for the improvement of state owned lands administered by the state land board. (State Board of Land Commissioners and Land/Water Management Section; 36-1-144, C.R.S. 1973))
 33. Joins the federal government or other parties in cooperative plans for the development of oil and gas pools. (State Board of Land Commissioners, Land-Water Management Section and Fiscal-Accounting Section; 36-1-115, C.R.S. 1973))
 34. Coordinates mine safety activities with the federal government in accordance with the "Federal Coal Mine Health and Safety Act of 1969". (Colorado Division of Mines, Chief Coal Mine Inspector Section; 34-21-133 (1), C.R.S. 1973))
 35. Carries out the requirements of federal grants to assist the state in developing and enforcing coal mine health and safety laws; improves Colorado's workmen's compensation laws relating to coal mines; promotes federal/state coordination in improving health and safety conditions in coal mines; conducts hearings; makes investigations and takes such action as is necessary in accordance with objectives and requirements of federal grants. (Colorado Division of Mines, Chief Coal Mine Inspector Section; 34-21-133 (2) (a) through (e), C.R.S. 1973))

State-Local Relations

Resource Management

36. ~~ASSISTS COUNTIES; MUNICIPALITIES AND OTHER PUBLIC~~ agencies to contract for weather modification operations. ~~(Executive Director's Office, Weather Modification Program; 36-20-108 (4) (6), C.R.S. 1973)~~
37. Reviews the tax dollar loss impact statements from boards of commissioners in counties eligible for payments in lieu of taxes; determines the dollar amounts to be paid and certifies the amounts to the general assembly. (Division of Wildlife, Administrative Services Section, and Division of Parks and Outdoor Recreation, Board of Parks and Outdoor Recreation; 33-1-108 (4) and 33-30-104 (1) (g), C.R.S. 1973)
38. Coordinates the work of the Division of Water Resources with other state and local agencies. (Division of Water Resources, State Engineer and Assistant State Engineers; 37-80-102 (1) (c), C.R.S. 1973)
39. Serves as consultant to boards of county commissioners on the prevention and remedy of soil blowing. (State Soil Conservation Division; 35-72-103 (1), C.R.S. 1973)
40. Cooperates with the local soil conservation districts in the designation of natural hazard areas. (State Soil Conservation Division; 35-70-103 (5) (d), C.R.S. 1973)
41. Reviews plans submitted by local governments to determine whether local development will interfere with extraction of commercial mineral deposits and makes recommendations on subdivision reports submitted by local governments. (Colorado Geological Survey, Mineral Resources, and Mineral Fuels Sections; 30-28-136 (1) (i) and 34-1-103 (4), C.R.S. 1973)
42. Contracts with local governments for development, operation and maintenance of local parks and recreation areas. (Board of Parks and Outdoor Recreation; 33-30-105 (1) (f), C.R.S. 1973)
43. Encourages and assists the development and maintenance of recreational trails by local governments. (Division of Parks and Outdoor Recreation, Statewide Field Services Section; 33-42-102 (2), C.R.S. 1973)
44. Coordinates trail development among local governments and assists local governments in their trail plans by reviewing records of available easements and other land interests for adaptation to trail usage. (Division of Parks and Outdoor

Recreation, Planning and Development Unit, Recreation Trails Committee; 33-42-106, C.R.S. 1973)

45. Develops criteria for trails to be adopted by the state parks and recreation board and recommends allocation of funds among local governments. (Division of Parks and Outdoor Recreation, Planning and Development Unit, Recreation Trails Committee; 33-42-107, C.R.S. 1973))
46. Designates floodwater runoff channels and basins and provides the information to local governments. (Water Conservation Division, Director's Office; 37-60-106 (1) (c) and (d), C.R.S. 1973))
47. Provides all boards of county commissioners with an opinion regarding the adequacy of the water supply and the likelihood of material injury to other water rights for each preliminary plan for a subdivision. (Division of Water Resources, Engineering Section, Water Management Unit; 30-28-136 (1) (h) (I), C.R.S. 1973))
48. Files written comments on each water supply report submitted by a municipality or quasi-municipality in support of a proposed subdivision within its service area. (Division of Water Resources, Engineering Section, Water Management Unit; 30-28-136 (1) (h) (I), C.R.S. 1973))

Preserves and Protects the State's Natural Resources

49. Develops and directs a state resource management plan. (Executive Director; 24-33-103, C.R.S. 1973))
50. Promulgates rules for the designation of natural areas and for the development of plans for the management of designated natural areas. (Executive Director's Office, Natural Areas Program; 36-10-105 (1) (a) (III), C.R.S. 1973))
51. Exercises property rights over all wildlife in the state and regulates exportation and importation, transfer, sale, donation and possession of the state's wildlife. (Division of Wildlife, Wildlife Commission; 33-1-104, C.R.S. 1973))
52. Informs prospectors of required land reclamation. (Mined Land Reclamation Division, Minerals Section; 34-32-113 (5), C.R.S. 1973))
53. Designates areas unsuitable for all or certain types of coal mining. (Mined Land Reclamation Division, Board, Coal Permitting and Enforcement Section; 34-33-126, C.R.S. 1973))

54. Develops an abandoned mine reclamation plan and expends grant moneys on such programs. (Mined Land Reclamation Board, Clerical and Administrative Staff, Inactive Mine Program and Technical Services Sections; 34-33-133, C.R.S. 1973)
55. Regulates the drilling and construction of any well to prevent the waste of water and damage to other water resources. (Division of Water Resources, Ground Water Section, Well Drilling Inspectors; 37-90-138 (1) and (2), C.R.S. 1973)
56. Establishes programs, including acquisition of land and water habitats, for management of nongame wildlife and enters into agreements with governmental or private parties to accomplish program purposes. (Division of Wildlife, Nongame Program and Administrative Services Sections and all Regional Offices; 33-8-106 (1) and (2), C.R.S. 1973)
57. Promotes and assists the organization and operation of local soil conservation districts. (State Soil Conservation Division; 35-70-103 (5) (a), C.R.S. 1973)
58. Loans money to local soil conservation districts for conservation purposes. (State Soil Conservation Division; 35-70-103 (5) (h), C.R.S. 1973)
59. Assists local soil conservation districts in drafting annual and long-range plans and reviews those plans. (State Soil Conservation Division; 35-70-103 (5) (b), C.R.S. 1973)
60. Identifies, evaluates and protects specific examples of ecosystems, ecological communities and other unique natural features. (Executive Director's Office, Natural Areas Program; 36-10-102 and 104, C.R.S. 1973)
61. Protects, preserves, and manages wildlife and their environment and natural, scenic, scientific and outdoor recreation areas by developing state parks and natural environment recreation areas. (Division of Wildlife and Division of Parks and Outdoor Recreation; 33-1-101, C.R.S. 1973)
62. Captures, exchanges, and provides for propagation of wildlife species needed to stock the state's lands or waters. (Division of Wildlife, Wildlife Commission, Wildlife Services, Fish, Game and Nongame Sections and also all Regional Offices; 33-1-112 (1) (d), C.R.S. 1973)
63. Feeds wildlife suffering from severe weather conditions or food shortage. (Division of Wildlife, Regional Offices; 33-1-105, C.R.S. 1973)

- 64. Promotes the conservation and greatest utilization of the state's waters and the prevention of floods. (Water Conservation Board and Flood Plan Management Section; 37-60-102 and 106 (1) (a) and (b), C.R.S. 1973)
- 65. Promotes the development of oil and gas, the protection and conservation of oil and gas resources, and protects the rights of owners. (Oil and Gas Conservation Commission and Office of the Director; 34-60-102, C.R.S. 1973)
- 66. Inspects mine reclamation projects prior to the release of performance bonds. (Mined Land Reclamation Division, Board, Coal Permitting and Enforcement Section; 34-33-125, C.R.S. 1973)

Promotes Environmental Safety
and Conducts Safety Inspections

- 67. Determines areas of geologic hazards. (Colorado Geological Survey, Engineering and Environmental Geology Section; 34-1-103 (1) (i), C.R.S. 1973)
- 68. Establishes miner training and retraining programs and makes them available to mine operators and miners who request assistance in meeting requirements of federal law. (Colorado Division of Mines, Chief Coal Mine Inspector Section; 34-26-114 (2), C.R.S. 1973)
- 69. Requires that all miners take safety education and training courses and annual refresher training and approves safety education and training made available to miners. (Colorado Division of Mines, Clerical and Metal Mine Inspectors Sections; 34-40-122 (1) and (3), C.R.S. 1973)
- 70. Regulates the manufacture, storage, transportation and use of explosives for mining purposes. (Colorado Division of Mines, Clerical and Metal Mine Inspectors Sections; 34-47-103 (2) and 104 (2), C.R.S. 1973)
- 71. Requires the drilling, casing, operation and plugging of seismic holes or exploratory wells in such a manner as to prevent pollution of water and prevent cave-ins, explosions, and fires. (Oil and Gas Conservation Commission, Field Operations Section; 34-60-106 (1) (c), C.R.S. 1973)
- 72. Coordinates a statewide course in safety and competency in the handling of firearms and cooperates with local governments or private organizations to insure that all hunters possess a certificate of such competency. (Division of Wildlife, Information Services; 33-4-113 and 115, C.R.S. 1973)

73. Examines, under cooperative agreement with the state Division of Labor, construction work on dams, highways and excavations where rock drills and explosives are used. (Colorado Division of Mines, Clerical and Metal Mine Inspectors Sections; 34-40-105 (1), C.R.S. 1973)
74. Inspects all metal mines at any time; reports dangerous conditions to mine owner and brings an injunction against a mine owner to stop operation if dangerous situations are not remedied. (Colorado Division of Mines, Clerical and Metal Mine Inspectors Sections; 34-40-110 (1) (b), 113 (1) and 115 (1), C.R.S. 1973)
75. Annually inspects each coal mine with 75 or fewer employees, recommends changes to owner and receives owner's report of compliance. (Colorado Division of Mines, Chief Coal Mine Inspector Section; 34-22-101, C.R.S. 1973)
76. Conducts an investigation when serious accidents occur, makes a report within ten days, and inspects a mine when operations resume. (Colorado Division of Mines, Chief Coal Mine Inspector Section; 34-29-118, C.R.S. 1973)
77. Inspects all mines operated under leases from the state for production of minerals upon which royalties are due the state. (State Board of Land Commissioners, Minerals Section and Fiscal-Accounting Section; 36-1-138 (1), C.R.S. 1973)
78. Examines conditions of buildings and machinery used in mines with 75 or fewer employees and areas around such mines. (Colorado Division of Mines, Clerical and Metal Mine Inspectors Sections; 34-40-105 (1), C.R.S. 1973)
79. Orders cessation of coal mining if conditions present imminent danger to the health or safety of the public. (Mined Land Reclamation Division, Coal Permitting and Enforcement Section; 34-33-123 (1), C.R.S. 1973)
80. Inquires into the cause of any mine accident. (Colorado Division of Mines, Clerical and Metal Mine Inspectors Sections; 34-40-110 (3), C.R.S. 1973)
81. Examines coal mine foremen, electricians, shot-firers, and other coal mine officials for competency. (Colorado Division of Mines, Chief Coal Mine Inspectors Section; 34-21-101, 108 and 109, C.R.S. 1973)
82. Inspects reclaimed land and releases warranties of a limited impact operator. (Mined Land Reclamation Division, Board and Minerals Section; 34-32-110 (5), C.R.S. 1973)

83. Inspects coal mine operations on an average of one partial inspection per mine per month and one complete inspection per quarter. (Mined Land Reclamation Division, Coal Permitting and Enforcement Section; 34-33-122 (4), C.R.S. 1973)
84. Determines the amount of water which is safe to store in reservoirs in the state and withdraws water when unsafe conditions exist. (Division of Water Resources, Engineering Section, Dam Safety Unit; 37-87-107, 109 and 110, C.R.S. 1973)

Provides Administrative and
Management Services

Data Collection and Reporting

85. Requests information from the State Board of Agriculture on forests and forestry in the state. (Executive Director's Office; 24-33-102 (4), C.R.S. 1973)
86. Establishes an inventory of natural areas in the state and maintains a registry of such areas. (Executive Director's Office, Natural Areas Program; 36-10-105 (1) (a) (1), C.R.S. 1973)
87. Submits to the governor a report every three years on the status of designated areas and the areas in the natural areas registry. (Executive Director's Office, Natural Areas Program; 36-10-105 (1) (a) (VIII), C.R.S. 1973)
88. Participates in and promotes continuous research and development in the theory of weather modification, the utilization of weather modification, and the protection of life, property and the environment from such operations. (Executive Director's Office, Weather Modification Program; 36-20-108 (5), C.R.S. 1973)
89. Publishes a conservation magazine on a paid subscription basis. (Division of Wildlife, Information Services; 33-1-126, C.R.S. 1973)
90. Maintains and furnishes information on wildlife migration areas. (Division of Wildlife, Wildlife Services; 33-3-105, C.R.S. 1973)
91. Develops information on nongame wildlife populations, habitats, and other data necessary to determine management measures required for continuation of the species. (Division of Wildlife, Nongame and Wildlife Research Sections and all Regional Offices; 33-8-104 (1) and 33-8-105, C.R.S. 1973)

92. Requires annual reporting of information from licensees of controlled shooting areas. (Division of Wildlife, Law Enforcement Section and Regional Offices; 33-40-113, C.R.S. 1973)
93. Encourages and oversees scientific research and educational use of natural areas, conducts or encourages interpretive programs, and distributes information and recommendations on natural areas. (Executive Director's Office and Natural Areas Program; 36-10-105 (1) (a) (V), C.R.S. 1973)

Energy Development

94. Contracts with the Colorado School of Mines to develop research on coal mining, coal marketing, and related scientific, technical and economic fields, and accepts grants from and contracts with the Office of Coal Research of the federal Department of Interior. (Executive Director's Office; 24-33-105, C.R.S. 1973)
95. Assembles data and develops common standards for evaluating the impacts of energy development and economic growth on demographics and local government expenditures and revenues. (Executive Director's Office, Cumulative Impacts Task Force; no statutory mandate)
96. Collects and automates data on major energy projects, energy-related projects, natural resources, and related environmental and economic factors; evaluates the data; and makes projections. (Executive Director's Office, Resource Inventory System; 24-1-107, C.R.S. 1973)
97. Requires that persons producing, selling, purchasing, processing, or transporting oil or gas keep complete records of quantities available and that such persons file reports as prescribed. (Oil and Gas Conservation Commission, Drilling and Production Section; 34-60-106 (1) (e), C.R.S. 1973)
98. Prepares, publishes, and updates a directory of information on regulatory requirements at all levels of government for a mining/energy project. (Executive Director's Office, Joint Review Process; 24-1-107, C.R.S. 1973)

Land

99. Transmits to the State Board of Agriculture an annual statement of all income from agricultural college lands. (State Board of Land Commissioners, Minerals Section, Land-Water Administration Section and Fiscal-Accounting Section; 36-1-142 and 143, C.R.S. 1973)

100. Publishes an annual summary of all land transactions of the State Board of Land Commissioners. (State Board of Land Commissioners, Fiscal-Accounting and Land/Water Management Sections; 36-1-102 (4), C.R.S. 1973)
101. Provides annually to each county assessor a list of equities owned or acquired and information on sale of lands conducted by the State Board of Land Commissioners in the county. (State Board of Land Commissioners, Fiscal Accounting Section; 36-1-132, C.R.S. 1973)
102. Evaluates the physical features of Colorado with reference to potential human and animal use. (Colorado Geological Survey, Engineering and Environmental Geology Section; 34-1-103 (1) (g), C.R.S. 1973)

Minerals and Mining

103. Develops, collects and preserves geologic information. (Colorado Geological Survey, Mineral Resources, Ground Water Investigations, Mineral Fuels and Engineering and Environmental Geology Sections; 34-1-103 (1) (c) and (e), C.R.S. 1973)
104. Inventories and analyzes the state's mineral resources. (Colorado Geological Survey, Mineral Resources, Ground Water Investigations, Mineral Fuels, and Engineering and Environmental Geology Sections; 34-1-103 (1) (d) and 34-1-303, C.R.S. 1973)
105. Prepares, publishes and distributes reports, maps and bulletins on geologic processes. (Colorado Geological Survey, Mineral Resources, Ground Water Investigation, Mineral Fuels, and Engineering and Environmental Geology Sections; 34-1-103 (1) (h), C.R.S. 1973)
106. Requires identification of oil or gas well ownership, filing of well logs, surveys, reports on production and other related matters. (Oil and Gas Conservation Commission, Office of the Director, Drilling and Production Section; 34-60-106 (1) (a) and (b), C.R.S. 1973)
107. Collects, marks, classifies, describes, and records for study and reference, specimens of geological and mineralogical substances found in Colorado, other states and countries. (Colorado Division of Mines, Clerical and Metal Mine Inspectors Sections; 34-40-109 (1) (a) and (b), C.R.S. 1973)
108. Collects and records historical data on the mining industry in Colorado. (Colorado Division of Mines, Clerical and Metal Mine Inspectors Sections; 34-40-109 (1) (d), C.R.S. 1973)

109. Examines and reports on the geological formation of each mining district and each important mine in the state, including specifics on their physical character. (Colorado Division of Mines, Clerical and Metal Mine Inspectors Sections; 34-40-109 (1) (e), C.R.S. 1973)
110. Investigates and records advancements in the use of labor saving devices in all branches of mining operations and the smelting, concentrating, milling and dressing of metalliferous ores. (Colorado Division of Mines, Clerical and Metal Mine Inspectors Sections; 34-40-109 (1) (g) and (h), C.R.S. 1973)
111. Distributes information on the production, supply, location, character and economic use of Colorado resources in coal, coal oil, asphalt, iron, building stone, slates, marble, fire clays, cements, pottery and porcelain clays, asbestos, mica and various mineral waters. (Colorado Division of Mines, Clerical and Metal Mine Inspectors Sections; 34-40-109 (1) (i), C.R.S. 1973)
112. Investigates and reports successful methods for satisfying and reclaiming mineral areas. (Colorado Division of Mines, Clerical and Metal Mine Inspectors Sections; 34-40-109 (1) (m), C.R.S. 1973)
113. Maintains records on the number of coal mines, miners, accidents, inspections of mines, production of each mine and county, and other information. (Colorado Division of Mines, Clerical Section; 34-21-127 (1) (a), (b), and (c), C.R.S. 1973)
114. Initiates and encourages studies and programs to develop less destructive methods of surface coal mining and better methods of land reclamation. (Mined Land Reclamation Division, Office of Director, Coal Permitting and Enforcement, and Technical Services Sections; 34-32-107 and 34-33-107, C.R.S. 1973)
115. Establishes a coal mining reclamation data base and inventory system to evaluate different land areas for reclamation capacity to be available to those making land use decisions and to provide evaluation of lands in the natural areas registry and designation list. (Mined Land Reclamation Division, Coal Permitting and Enforcement, and Technical Services Sections; 34-33-130 (1), C.R.S. 1973)
116. Carries on a continuing review of problems of mining and land reclamation and surface coal mining and land reclamation. (Mined Land Reclamation Division and Board, Coal Permitting and Enforcement, Technical Services, and Minerals Sections; 34-32-106 (1) (a) and (b), C.R.S. 1973)

117. Receives notification of the abandonment of a coal mine, notification of a new mine prior to opening, and resumption of work after abandonment. (Colorado Division of Mines, Chief Coal Mine Inspector Section; 34-29-129, C.R.S. 1973)
118. Receives monthly reports from coal operators relating to production figures, number of employees, and accidents. (Colorado Division of Mines, Clerical and Chief Coal Mine Inspector Sections; 34-29-133 and 134, C.R.S. 1973)

Water

119. Rates the measuring devices erected by dam, canal, and ditch owners and maintains records and rating tables on such devices. (Division of Water Resources, State Engineer, Water Divisions and Engineering Section; 37-84-114, C.R.S. 1973)
120. Makes continuous studies of the state's water resources and the present and potential uses in cooperation with the Division of Water Resources. (Water Conservation Division, Project Construction and Planning Sections; 37-60-115 and 116, and 37-80-102 (7), C.R.S. 1973)
121. Supervises the measurement, recordkeeping and distribution of the state's public waters. (Division of Water Resources, Water Divisions Section, Hydrology and Water Management and Well Permits Units; 37-80-102 (1) (h), C.R.S. 1973)
122. Exercises authority over data collection on snowfall and runoff. (Division of Water Resources, Water Divisions and Engineering Section, Water Management and Water Supply Units; 37-80-102 (1) (i), C.R.S. 1973)
123. Directs the gathering and distribution of data on surface and groundwater supplies. (Division of Water Resources, Engineering Section, Water Supply and Water Management Unit; 37-80-102 (7), C.R.S. 1973)
124. Appoints a deputy to secure data on any canal, dam, or reservoir required for court decrees or records. (Division of Water Resources, State Engineer; 37-80-108, C.R.S. 1973)
125. Keeps records showing the dates of ground water priority claims. (Division of Water Resources, Ground Water Section, Designated Basins Unit; 37-90-109 (2), C.R.S. 1973)
126. Prepares for publication a tabulation of all decreed water rights and conditional water rights. (Division of Water Resources, State Engineer, Water Divisions Section; 37-92-401 and 402, C.R.S. 1973)

127. Records all wells put to beneficial use prior to May 8, 1972 and any wells exempted upon written application accompanied by a fee. (Division of Water Resources, Ground Water Section, Well Permits Unit; 37-92-602 (5), C.R.S. 1973)

Enforcement

128. Enforces the laws on wildlife and parks and outdoor recreation. (Division of Wildlife, all Regional Offices and Division of Parks and Outdoor Recreation, Regional Services Section; 33-6-101, C.R.S. 1973)
129. Seizes wildlife held in violation of wildlife statutes; arrests persons; searches places of concealment; and calls upon local law enforcement authorities for assistance. (Division of Wildlife, all Regional Offices and Division of Parks and Outdoor Recreation, Regional Services Section; 33-6-101 (1), C.R.S. 1973)
130. Brings civil action to recover possession of wildlife taken, killed, injured, or held in violation of wildlife statutes. (Division of Wildlife, Fish, Game Programs, Nongame and Law Enforcement Sections, and all Regional Offices; 33-4-107, C.R.S. 1973)
131. Revokes, cancels, and suspends any license or permit issued by the division if the holder has violated laws related to wildlife and outdoor recreation. (Division of Wildlife, Law Enforcement Section and all Regional Offices; 33-6-128, C.R.S. 1973)
132. Enforces the federal "Migratory Bird Treaty Act" in Colorado. (Division of Wildlife, Nongame Program Section; 33-20-102, C.R.S. 1973)
133. Enforces the state's snowmobile statute. (Division of Wildlife, Law Enforcement Section and all Regional Offices and also Division of Parks and Outdoor Recreation, Regional Services Section; 33-7-118, C.R.S. 1973)
134. Enforces boat safety on the waters of the state. (Division of Wildlife, Regional Offices and Division of Parks and Outdoor Recreation, Regional Services Section; 33-31-111, C.R.S. 1973)
135. Enforces safety laws relating to recreational vehicles. (Division of Wildlife, Regional Offices, and Division of Parks and Outdoor Recreation, Regional Services Section; 33-43-107 (2), C.R.S. 1973)
136. Exercises powers of peace officers to enforce mine safety. (Colorado Division of Mines, Clerical and Metal Mine Inspectors Sections; 34-47-128 (1), C.R.S. 1973)

137. Makes and enforces regulations to enable the state to meet its water compact commitments. (Division of Water Resources, State Engineer; 37-80-104, C.R.S. 1973)
138. Applies to the water judge for an injunction against those persons who have failed to comply with orders issued pursuant to law. (Division of Water Resources, State Engineer; 37-90-503, C.R.S. 1973)

Fees, Licenses and Permits

139. Collects fees for the issuance of leases, rights of way, patents, and other documents. (State Board of Land Commissioners, Minerals Section and Fiscal-Accounting Section; 36-1-112, C.R.S. 1973)
140. Considers applications for limited impact operations and reviews annual reports and collects fees from limited impact operators. (Mined Land Reclamation Division, Clerical and Administrative Staff, and Minerals Section; 34-32-110 (1) through (4), C.R.S. 1973)
141. Collects fees for various services performed and transmits such funds to the state treasury for deposit in the state's general fund. (Division of Water Resources, State Engineer's Office; 37-80-110 and 111, C.R.S. 1973)
142. Approves the lease or license granted by the Colorado Department of Health for the concentration, storage, or disposal of radioactive materials. (Division of Water Resources, Geotechnical Services, and Water Management Unit; 25-11-103 (7) (b), C.R.S. 1973)

Minerals

143. Requires notice by discoverer of minerals on unleased state land; requires exploratory permit and a lease agreement. (State Board of Land Commissioners, Minerals Section and Fiscal-Accounting Section; 36-1-140, C.R.S. 1973)
144. Requires that a permit be obtained for the drilling of an oil or gas well before work is commenced. (Oil and Gas Conservation Commission, Office of Director; 34-60-106 (1) (f), C.R.S. 1973)
145. Requires certificates of clearance in connection with transportation and delivery of oil and gas. (Oil and Gas Conservation Commission, Drilling and Production Section; 34-60-106 (1) (i), C.R.S. 1973)

Mining Operations

146. Issues permits for use of diesel engines in metal mines of all sizes. (Colorado Division of Mines, Clerical and Metal Mine Inspectors Sections; 34-47-131, C.R.S. 1973)
147. Issues permits to mine operators to store, transport and use explosives. (Colorado Division of Mines, Chief Coal Mine Inspector Section; 34-27-101, C.R.S. 1973)
148. Issues permits and collects fees for operation of diesel engines in coal mines. (Colorado Division of Mines, Clerical and Chief Coal Mine Inspector Sections; 34-29-136, C.R.S. 1973)
149. Grants a permit for mining operations upon the receipt of an application giving specifics on proposed mine, the area to be mined, reclamation plans, and maps. (Mined Land Reclamation Division, Board, and Minerals Section; 34-32-112 (1) through (5), C.R.S. 1973)
150. Receives and reviews applications for permits to perform surface coal mining. (Mined Land Reclamation Division, Coal Permitting and Enforcement, Technical Services Sections; 34-33-110, C.R.S. 1973)
151. Processes applications and issues decisions granting or denying a mining permit, informing applicant of necessary modifications. (Mined Land Reclamation Division, Clerical and Administrative Staff, Coal Permitting and Enforcement Section; 34-33-114, C.R.S. 1973)
152. Organizes and coordinates for individual companies the permitting requirements on all levels of government which are necessary for establishment of a large mining/energy project. (Executive Director's Office, Joint Review Process; 24-1-107, C.R.S. 1973)

Recreation

153. Designates agents to sell passes, permits, licenses, and certificates to the public. (Division of Wildlife, Planning and Administrative Services Sections and all Regional Offices, and Division of Parks and Outdoor Recreation, Business Management Section; 33-4-112, C.R.S. 1973)
154. Registers and collects license fees for snowmobiles. (Division of Parks and Outdoor Recreation, Statewide Services Section; 33-7-102, C.R.S. 1973)

155. Issues numbered certificates to operators of motorboats and sailboats. (Division of Parks and Outdoor Recreation, Statewide Services Section; 33-31-103 (1) and 33-31-104, C.R.S. 1973)
156. Assigns identification numbers and registers recreational vehicles, collects fees and may employ agents to issue temporary registrations. (Division of Parks and Outdoor Recreation, Statewide Services Section; 33-43-102, C.R.S. 1973)

Water Development

157. Determines, following publication and absent objections, that if a proposed appropriation of water will not impair existing water rights or result in waste, an application shall be approved and a conditional well permit issued. (Division of Water Resources, Ground Water Commission, Hearings Office; 37-90-107 (3), C.R.S. 1973)
158. Approves permits for certain small capacity water wells. (Division of Water Resources, Ground Water Section, Designated Basins Unit; 37-90-105 (1), C.R.S. 1973)
159. Reviews well applications, conducts public hearings, and orders the state engineer to issue a well permit after a permit applicant has properly completed the well and furnished certain information to the commission. (Division of Water Resources, Ground Water Commission, State Engineer, and Hearings Office; 37-90-107 (2), (4), and 108 (3), C.R.S. 1973)
160. Conducts a hearing on tentative priority dates for water rights, and thereafter, establishes priority dates and issues final permits. (Division of Water Resources, Ground Water Section, Ground Water Hearing Officer; 37-90-109 (5), C.R.S. 1973)
161. Prohibits or limits withdrawal of water from any well if such withdrawal harms prior appropriators; establishes a ground water pumping level for an area; issues permits for replacement or substitute wells; orders total or partial discontinuance of any diversion; consults with the board of directors of the ground water management district in areas where there is one, and exercises any power granted to such bodies in areas where there is no district. (Division of Water Resources, Ground Water Section, Designated Basins Unit; 37-90-111, C.R.S. 1973)
162. Issues permits to water well drillers. (Division of Water Resources, Ground Water Section, Well Drilling Inspectors; 37-90-138 (3), C.R.S. 1973)

163. Examines for denial, approval, revocation, suspension or renewal licenses for the construction or abandonment of water wells and installation of pumping equipment; conducts hearings; collects application fees for licenses and registration fees for well drilling rigs. (Division of Water Resources, Ground Water Section, Well Drilling Inspectors; 37-91-104 and 112, C.R.S. 1973)
164. Reviews geothermal well permits and determines whether such issuance would injure vested water rights. (Division of Water Resources, Ground Water Section and Investigations Section; 34-70-107 (4), C.R.S. 1973)

Weather Modification

165. Administers the state's weather modification program, including issuance of licenses and permits, and promulgation of rules and regulations. (Executive Director's Office, Weather Modification Program; 36-20-105, C.R.S. 1973)
166. Assists in developing licensing standards, conducting studies, establishing operation requirements and in other matters regarding weather modification. (Executive Director's Office, Weather Modification Advisory Committee; 36-20-106 (1) (a), C.R.S. 1973)
167. Issues, with the advice of an advisory committee, permits for weather modification operations. The office also issues a weather modification license for one year to any applicant who meets the qualifications and in certain circumstances, exempts an operator from license and permit requirements or revises the terms of a permit. (Executive Director's Office, Weather Modification Program; 36-20-108 (1), 111, 114 and 115, C.R.S. 1973)

Wildlife

168. Sets up licensing requirements and rules and regulations concerning wildlife programs. (Division of Wildlife, Wildlife Commission; 33-1-100, C.R.S. 1973)
169. Issues permits to property owners to kill wildlife causing excessive damage. (Division of Wildlife, Wildlife Commission, Wildlife Services Section, and Regional Offices; 33-3-106, C.R.S. 1973)
170. Issues various types of licenses for the hunting of wildlife, and collects license fees. (Division of Wildlife, Administrative Services Section, and Regional Offices; 33-4-102, C.R.S. 1973)

171. Issues trappers' licenses, permits for shipping green pellets out of state, and enters into cooperative agreements with federal employees to allow trapping on government lands. (Division of Wildlife, Law Enforcement Section and all Regional Offices; 33-22-112, C.R.S. 1973)
172. Issues licenses for and enforces the laws relating to private and commercial lakes for fish propagation and fishing. (Division of Wildlife, Law Enforcement Section and Regional offices; 33-40-103, C.R.S. 1973)
173. Issues a permit for falconry field meets. (Division of Wildlife, all Regional Offices; 33-20-115, C.R.S. 1973)
174. Issues licenses for and enforces laws relating to the establishment and operation of wildlife parks to buy, sell, transport and propagate wildlife. (Division of Wildlife, Law Enforcement Section and Regional Offices; 33-40-104 and 111, C.R.S. 1973)
175. Issues licenses and enforces laws relating to the establishment and operation of a controlled shooting area for possessing and propagating small and big game and charging customers to hunt them. (Division of Wildlife, Law Enforcement Section, and Regional Offices; 33-40-105 through 109, and 33-40-111, C.R.S. 1973)
176. Issues licenses for possession of raptors, and for transportation, purchase, and breeding of raptors. (Division of Wildlife, Law Enforcement and Nongame Program Sections and Regional Offices; 33-20-109 and 110, C.R.S. 1973)

Hearings

177. Convenes the weather modification advisory committee or appoints a hearing officer to investigate complaints alleging damages from weather modification operations or that such operations are being conducted illegally. (Executive Director's Office, Weather Modification Program; 36-20-106 (2), C.R.S. 1973)
178. Conducts public hearings on lands of "unique economic or environmental value"; submits findings from such hearings to the joint budget committee and executive directors of the departments of agriculture and natural resources; and meets with executive directors to determine whether the Department of Natural Resources should request authorization for the general assembly to acquire such lands. (State Board of Land Commissioners; 24-33-107 (2) (a) (b) (c), C.R.S. 1973)

179. Hears and determines persons' claims of ownership of state lands and establishes rules and regulations to prevent fraudulent applications. (State Board of Land Commissioners, Land-Water Management Section; 36-1-131, C.R.S. 1973)
180. Holds hearings on matters affecting interests of the Ground Water Commission. (Division of Water Resources, Ground Water Section, Hearings Office; 37-90-113 and 114, C.R.S. 1973)
181. Receives petitions for the formation of a ground water management district; holds a formal hearing to entertain objections and change boundaries if changes are hydrologically, geologically, and geographically sound; holds an election and designates the first board of directors. (Division of Water Resources, Ground Water Section, Designated Basins Unit, State Engineer, Ground Water Commission, Hearings Office; 37-90-120 through 125, C.R.S. 1973)
182. Reviews a petition, holds a hearing, and conducts an election for the addition of land to an existing groundwater management district in the same manner as for the formation of a new district or management district. (Division of Water Resources, Ground Water Commission; 37-90-140 and 141, C.R.S. 1973)
183. Accepts petitions for organization of a conservation district and conducts hearings on the sufficiency of the petition. (State Soil Conservation Division; 35-70-103 (5) (b) and 104 (1), C.R.S. 1973)
184. Conducts hearings and makes a determination on whether certain properties should not be included within a proposed soil conservation district. (State Soil Conservation Division; 35-70-105 (1) (d), C.R.S. 1973)
185. Acts as an appeals board for landowners appealing a decision of a local soil conservation district board of supervisors by giving notices, conducting hearings, and announcing its findings. (State Soil Conservation Division; 35-70-103 (5) (e) and 35-70-110, C.R.S. 1973)
186. Receives petitions for dissolution of a soil conservation district, gives publication notice, conducts a hearing on sufficiency of petition and advisability of dissolution, and conducts the election, which, if successful, is certified to the Division of Local Government by the State Board of Soil Conservation Districts. (State Soil Conservation Division; 35-70-118, C.R.S. 1973)

187. Acts as the board of appeals for each of the state's soil conservation districts. (State Soil Conservation Division; 35-70-113, C.R.S. 1973)

Internal Management and Support Services

188. Serves as the Commissioner of Mines. (Executive Director; 34-40-103, 24-33-102 (1), C.R.S. 1973)
189. Assists the Department of Natural Resources in the administration of the natural areas program including recommendations regarding the inventory and registry and criteria for the selection of natural areas, assistance in seeking the designation of natural areas, recommendations regarding scientific research, educational use, and public information on the areas, recommendations on the expenditure of funds, and recommendations on the department's report to the governor. (Executive Director's Office, Colorado Natural Areas Council; 36-10-106 (1), 36-10-107 (1), C.R.S. 1973)
190. Prepares and transmits an annual report to the governor and general assembly on the efficient discharge of all responsibilities assigned to the Department of Natural Resources. (Executive Director's Office; 24-33-102 (2), C.R.S. 1973)
191. Exercises control over the publications of the department and all of its divisions. (Executive Director's Office; 24-33-102 (3), 33-1-108 (3), 37-60-117 (2), 36-1-103 (4) and (6), 34-60-104 (4), 35-70-103 (5) (i), 34-40-111 (3), 34-21-127 (4), C.R.S. 1973)
192. Exercises all functions of the state Board of Parks and Outdoor Recreation between its meetings, subject to its ratification, and acts as its recording secretary. (Division of Parks and Outdoor Recreation, Director's Office; 33-30-106 (1) (c), C.R.S. 1973)
193. Appoints special park officers who serve without pay but have the same powers as commissioned park officers. (Division of Parks and Outdoor Recreation, Director's Office; 33-30-107, C.R.S. 1973)
194. Administers federal funds under the "Land and Water Conservation Fund Act" on behalf of all agencies of state and local governments. (Division of Parks and Outdoor Recreation, Grants Section; 33-2-107, C.R.S. 1973)
195. Appoints special wildlife officers who serve without pay but possess the powers of a wildlife conservation officer. (Division of Wildlife, Office of the Director; 33-1-115 (5), C.R.S. 1973)

196. Issues and sells conservation stamps for the nongame cash fund. (Division of Wildlife, Information Services; 33-1-126, C.R.S. 1973)
197. Grants certain variances of environmental performance standards. (Mined Land Reclamation Division and Board, Coal Permitting and Enforcement Section; 34-33-120 (2) (p), and (5) (a) and (e), C.R.S. 1973)
198. Authorizes, on an individual experimental basis, departures from environmental protection performance standards. (Mined Land Reclamation Division Board, Coal Permitting and Enforcement Section; 34-33-134, C.R.S. 1973)
199. Exercises authority over construction contracts and professional and technical consultants. (Division of Water Resources, State Engineer and Assistant State Engineer; 37-80-102 (1) (e), C.R.S. 1973)
200. Serves as executive director of the Ground Water Commission. (Division of Water Resources, State Engineer; 37-90-104 (6), C.R.S. 1973)

Resource Management

Land, Minerals and Mining

201. Supervises the administration of the Colorado Natural Areas Program. (Executive Director's Office; 36-10-101 et seq., 24-1-124 (5), C.R.S. 1973)
202. Reclassifies and reappraises state lands. (State Board of Land Commissioners, Land-Water Management Section; 36-1-109, C.R.S. 1973)
203. Keeps records of transactions, receives proposals for construction of irrigation works, prepares maps, and administers provisions of the law on desert land for the Board of Land Commissioners. (State Board of Land Commissioners, Land-Water Management Section; 36-3-105 and 106, C.R.S. 1973)
204. Issues rules regulating the sale of timber, protection of young growth, the filing of applications, issuing of permits, and appraisal of timber. (State Board of Land Commissioners, Land-Water Management Section and Fiscal-Accounting Section; 36-7-104, C.R.S. 1973)
205. Administers the Land and Water Management Fund for the improvement of state owned lands and waters administered by the land board. (State Board of Land Commissioners, Land-Water Management Section; 36-1-148, C.R.S. 1973)

206. Administers the state forest lands, including leasing and timbering agreements. (State Board of Land Commissioners, Land-Water Administration Section and Fiscal Accounting Section; 36-7-201, C.R.S. 1973)
207. Adopts rules and regulations for the administration, protection and maintenance of areas under the jurisdiction of the State Board of Parks and Outdoor Recreation, including the preservation of buildings, property, wildlife and objects of special scientific interest, and restrictions on the use of the area and sanitation, health and safety measures. (Board of Parks and Outdoor Recreation; 33-30-108 (1), C.R.S. 1973)
208. Enters into agreements with persons contemplating surface coal mining to identify and coordinate all reviews, evaluations, and procedures required by all levels of government. (Mined Land Reclamation Division Board, Coal Permitting and Enforcement Section; 34-33-132, C.R.S. 1973)
209. Requires metering of oil and gas in pipelines, gathering systems, loading racks, and refineries. (Oil and Gas Conservation Commission, Office of Director, Drilling and Production Section; 34-60-106 (1) (j), C.R.S. 1973)
210. Regulates drilling, well production, plugging of wells and all other well operations. (Oil and Gas Conservation Commission, Office of Director, Field Operations Section; 34-60-106 (2) (a), (b), (c) and (d), C.R.S. 1973)
211. Prescribes rules and regulations governing the exercise of its functions under the federal "Natural Gas Policy Act of 1978" or other federal laws affecting price and allocation of natural gas and crude oil. (Oil and Gas Conservation Commission; 34-60-106 (8), C.R.S. 1973)
212. Regulates the drilling, operating, monitoring and abandonment of geothermal wells, including the issuance of exploration and development permits. (Oil and Gas Conservation Commission, Office of Director; 34-70-102, 104 (1) and 106 (3), C.R.S. 1973)
213. Administers the coal reclamation program under the federal "Surface Mining Control and Reclamation Act of 1977". (Mined Land Reclamation Division, Coal Permitting and Enforcement Section; 34-33-109, C.R.S. 1973)
214. Reviews the data and plans submitted to construct irrigation projects on state desert lands, determines the feasibility of such projects and reports to the state land board. (Division of Water Resources, State Engineer; 36-3-109 and 110, C.R.S. 1973)

215. Establishes the boundary between two counties when it is in dispute. (Division of Water Resources, State Engineer; 30-6-110, C.R.S. 1973)
216. Administers any funds made available for the purpose of assisting soil conservation districts in carrying out their program. (State Soil Conservation Division; 35-70-103 (5) (g), C.R.S. 1973)
217. Supervises a simplified system for withdrawal of lands from a soil conservation district. (State Soil Conservation Division; 35-70-115 (9), C.R.S. 1973)
218. Calls a soil conservation district election, publishes relevant information about the election, conducts the proceedings, and serves as election judge. (State Soil Conservation Division; 35-70-105 (5), C.R.S. 1973)
219. Reviews and approves the local soil conservation districts' budgets, audits, annual reports, accounting system and memoranda of understanding. (State Soil Conservation Division; 35-70-103 (5) (e) and 110, C.R.S. 1973)
220. Approves the transfer of land from one soil conservation district to another. (State Soil Conservation Division; 35-70-115 (8), C.R.S. 1973)
221. Manages a conservation trust fund. (State Soil Conservation Division; 35-70-103, C.R.S. 1973)

Recreation

222. Administers the snowmobile recreation fund for the establishment and maintenance of snowmobile trails. (Division of Parks and Outdoor Recreation, Statewide Services Section; 33-7-105, C.R.S. 1973)
223. Adopts rules and regulations, in cooperation with state and local agencies to control and regulate the operation of snowmobiles. (Division of Parks and Outdoor Recreation, Statewide Services Section; 33-7-106 (b), C.R.S. 1973)
224. Issues rules and regulations controlling the use of innertubes and similar devices on rivers and streams. (Division of Parks and Outdoor Recreation, Statewide and Regional Services Sections; 33-31-102.5, C.R.S. 1973)
225. Issues rules and regulations establishing an identification numbering system for boats in compliance with the federal boat numbering systems. (Board of Parks and Outdoor Recreation; 33-31-103 (3), C.R.S. 1973)

226. Administers the parks motorized recreational trails fund for maintenance and establishment of such trails. (Division of Parks and Outdoor Recreation, Statewide Services Section; 33-43-105, C.R.S. 1973)
227. Adopts rules and regulations relating to equipment for recreational vehicles, registration of recreational vehicles, and uniform signs and maps for use by all government agencies. (Division of Parks and Outdoor Recreation, Statewide Services Section; 33-43-106, C.R.S. 1973)
228. Adopts rules and regulations for the administration, protection, and maintenance of land and water acquired by the commission for the preservation of buildings, property, wildlife, and objects of special scientific interest, and restrictions related to the use of the property. (Division of Wildlife, Wildlife Commission; 33-1-111 (1), C.R.S. 1973)

Water Development

229. Administers the Water Conservation Board Construction Fund for the construction of projects pursuant to criteria established by the general assembly and sends an annual report to the general assembly on its proposed facilities and contracts. (Water Conservation Division, Project Construction Section; 37-60-121 (1), 37-60-122 (1) (a), C.R.S. 1973)
230. Orders a feasibility study on proposed water development projects, whether or not funded by the Water Conservation Board Construction Fund, and orders feasibility studies requested by the general assembly. (Water Conservation Division, Project Construction Section; 37-60-122 (1) (c), C.R.S. 1973)
231. Maintains a detailed record on irrigation works in the process of construction. (State Board of Land Commissioners; 36-3-125, C.R.S. 1973)
232. Reviews the plans and requires satisfactory construction of any small dam erected to form a reservoir on the dam owner's property. (Division of Water Resources, Engineering Section, Dam Safety Unit; 37-87-117, C.R.S. 1973)
233. Approves plans and specifications for livestock water tank dams prior to construction. (Division of Water Resources, Water Divisions and Engineering Section, Dam Safety Unit; 35-49-106, C.R.S. 1973)

234. Approves the plans, acts as consulting engineer during the construction, and gives final approval to the construction of any water reservoir of certain specified dimensions. (Division of Water Resources, Engineering Section, Dam Safety Unit; 37-87-105, C.R.S. 1973)
235. Determines losses in water exchanges and directs the construction and maintenance of facilities to accomplish water exchanges. (Division of Water Resources, Water Divisions and State Engineer; 37-83-104, C.R.S. 1973)
236. Keeps on file specifications for erosion control dams, revises the specifications when needed, and approves the applications for such construction. (Division of Water Resources, Engineering Section, Dam Safety Unit; 37-87-122, C.R.S. 1973)
237. Requires the construction of drainage facilities to reduce the amount of water impounded in livestock tanks. (Division of Water Resources, State Engineer and Engineering Section, Dam Safety Unit; 35-49-105, C.R.S. 1973)
238. Surveys the need for construction of irrigation ditches and canals along the Arkansas River. (Division of Water Resources, State Engineer; 37-88-102, C.R.S. 1973)
239. Withholds water delivery to ditch, canal, flume or reservoir owners who have failed to remedy defects in the maintenance or construction of their head gates, flumes or weirs. (Division of Water Resources, State Engineer and Water Divisions Section; 37-84-112 (2) and 113 and 37-84-117 (3), C.R.S. 1973)
240. Directs the construction and maintenance and supervises and controls the use of flumes, weirs and self-registering devices for the transfer of water. (Division of Water Resources, State Engineer Water Divisions Section; 37-83-102 and 37-24-118, C.R.S. 1973)
241. Determines evaporation loss from reservoirs situated in the bed of a natural stream and accordingly orders release of replenishment water from streambed reservoirs. (Division of Water Resources, Water Divisions Section; 37-84-117 (5), C.R.S. 1973)
242. Determines the loss of water in reservoirs due to evaporation and other causes to determine the proper allocation of the reservoir water. (Division of Water Resources, State Engineer, Water Divisions and Engineering Sections; 37-87-102, C.R.S. 1973)

243. Establishes designated ground water basins for the state. (Division of Water Resources, Ground Water Commission; 37-90-104 (6), 37-90-106 (1), 37-90-106 (2), C.R.S. 1973)
244. Approves or disapproves the boundaries of a proposed designated ground water management district. (Division of Water Resources, Ground Water Section, Designated Basins Unit; 39-90-119, C.R.S. 1973)
245. Approves the bonds posted by the board of directors of a new ground water district. (Division of Water Resources, Ground Water Section, Designated Basins Unit; 37-90-126, C.R.S. 1973)
246. Reviews and approves controls, regulations or conservation measures proposed by ground water management districts. (Division of Water Resources, Ground Water Commission, Ground Water Section, Designated Basins Unit; 37-90-130 and 131, C.R.S. 1973)
247. Assumes responsibility for administration and distribution of the state's waters. (Division of Water Resources, State Engineer; 37-92-301 and 501, C.R.S. 1973)
248. Issues orders to carry out the state's water laws to owners or users of water rights including orders to discontinue a diversion, keeping streams clear of obstructions. (Division of Water Resources, State Engineer, Water Divisions Section; 37-92-502, C.R.S. 1973)
249. Serves as a commissioner from Colorado to the following river compacts: Rio Grande, Costilla Creek, La Plata, Republican and South Platte. (Division of Water Resources, State Engineer; 37-63-101, 37-65-101, 37-66-101, 37-67-101, 37-68-101, C.R.S. 1973)
250. Approves the gauge rods at the outlet of every reservoir situated in the bed of a natural stream and the plans and specifications for the measuring flumes constructed in the channel of every stream discharging water into such a reservoir. (Division of Water Resources, Water Divisions Section; 37-84-117 (2), C.R.S. 1973)

Wildlife

251. Provides game damage prevention materials and pays damages caused by wildlife. (Division of Wildlife, Wildlife Services and Regional Offices; 33-3-103, C.R.S. 1973)

252. Issues regulations and develops management programs to allow nongame species to sustain and perpetuate themselves. (Division of Wildlife, Nongame Program and Law Enforcement Sections, and all Regional Offices; 33-8-104 (1), C.R.S. 1973)
253. Permits the removal, capture, or destruction of threatened or endangered species if human health or property are endangered or for scientific, educational or other special purposes. (Division of Wildlife, Nongame Program Section and all Regional Offices; 33-8-106 (3) and (4), C.R.S. 1973)
254. Issues rules and regulations controlling the killing or capture of any wild birds. (Division of Wildlife, Nongame Program Section; 33-20-103, C.R.S. 1973)

Department Totals:

\$322,324.2 K-G
 \$92,847.8 K-F
 \$54,057.6 K-C

1,133.24 FTE

DEPARTMENT OF NATURAL RESOURCES

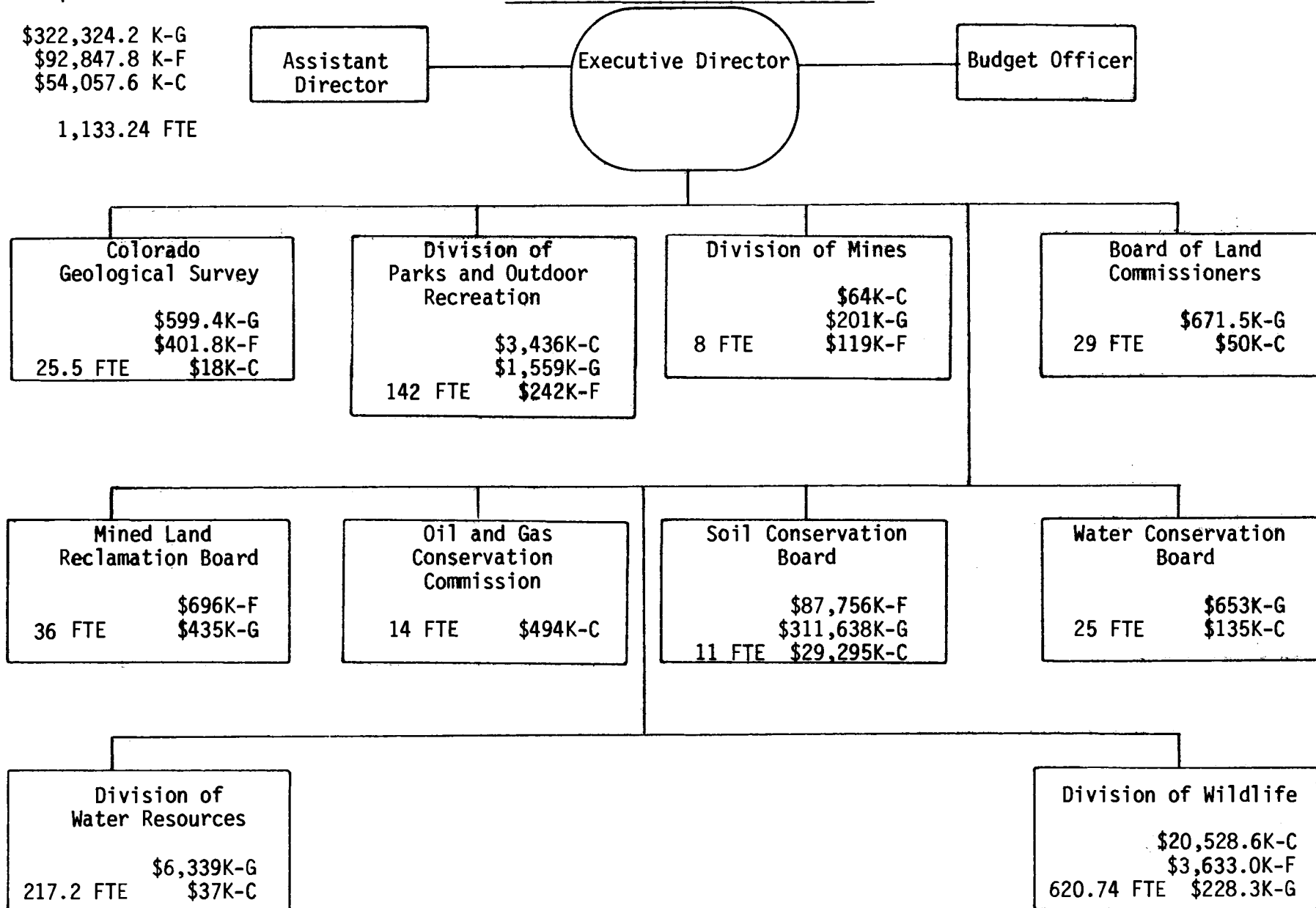

NR-30

Office Totals:

EXECUTIVE DIRECTOR'S OFFICE

\$3,388.4 K*

64.5 FTE

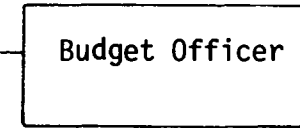
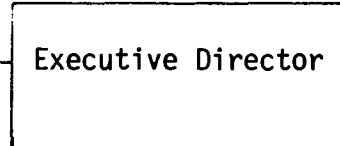

1a, 21a, 36c, 49a, 60c, 85a,
86-88c, 93c, 94a, 165c, 177c,
188a, 190b, 191a, 201a

Deputy Director

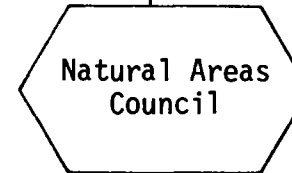

189a

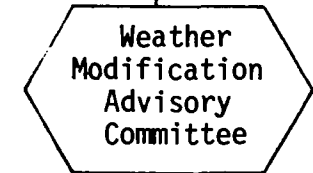

166a

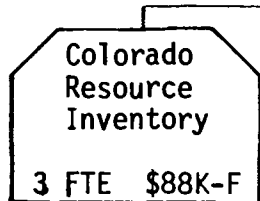

96a

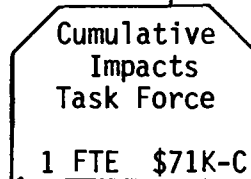

95a

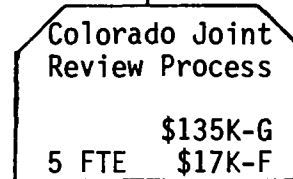

98a, 152a

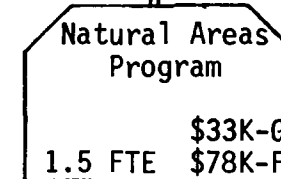

50a, 60a, 86a, 87a, 93a

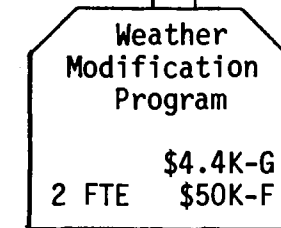

36a, 88a, 165a, 167a, 177a

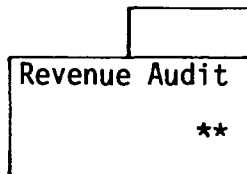

**

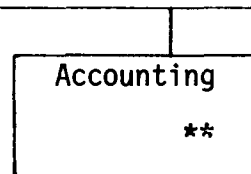

**

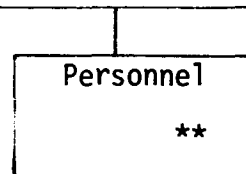

**

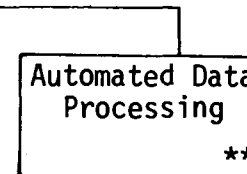

**

NR-31

* Funding sources not available.

** \$2,912K, 52 FTE for four agencies; detail by office not available.

Totals:

\$671.5 K-G
\$50 K-C

29 FTE

BOARD OF LAND COMMISSIONERS

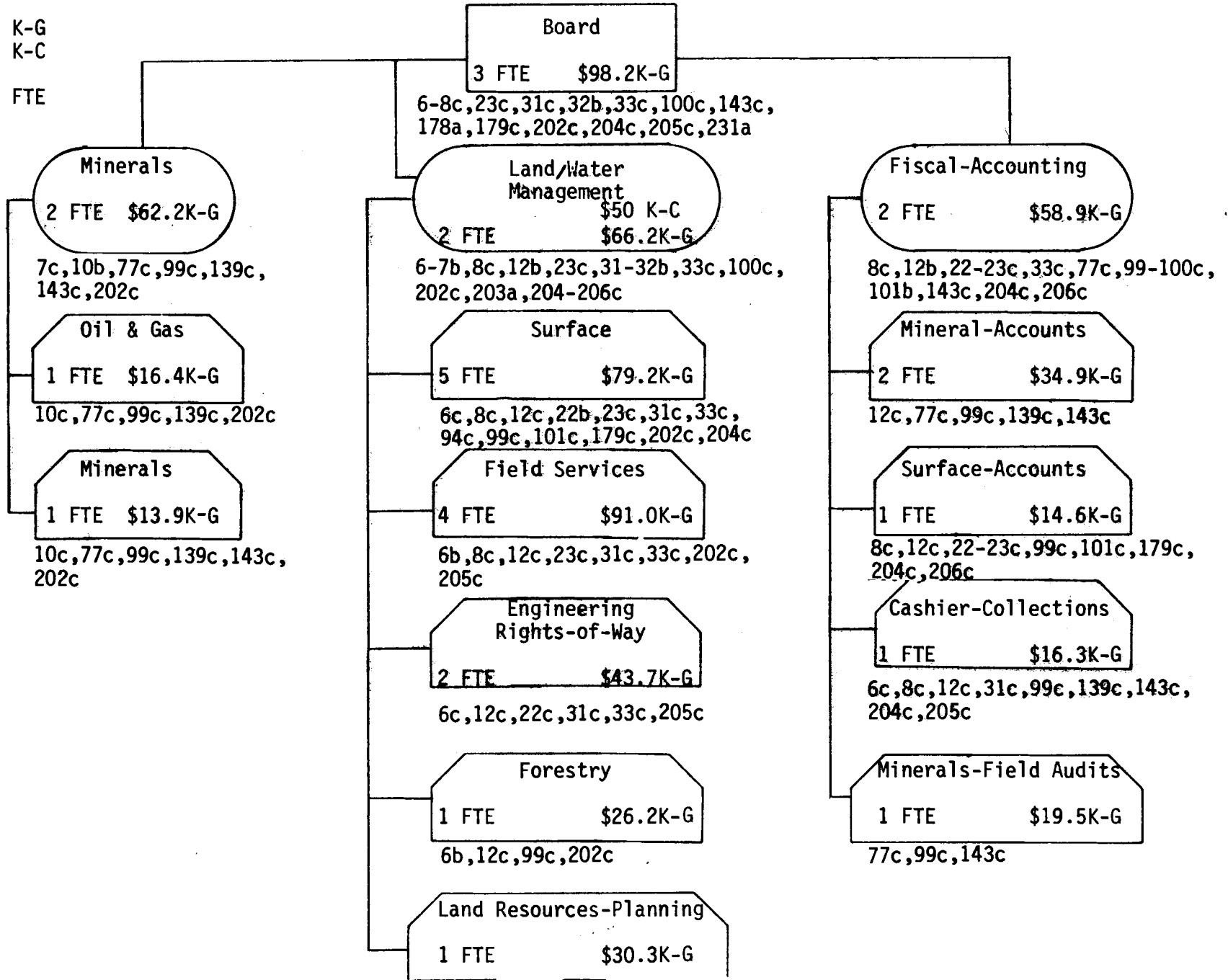

NR-32

Totals:

\$599.4 K-G

\$401.8 K-F

\$18 K-C

25.5 FTE

COLORADO GEOLOGICAL SURVEY

Director's Office
2 FTE \$110.2K-G

Staff Assistant
2c,29c,103c,104c

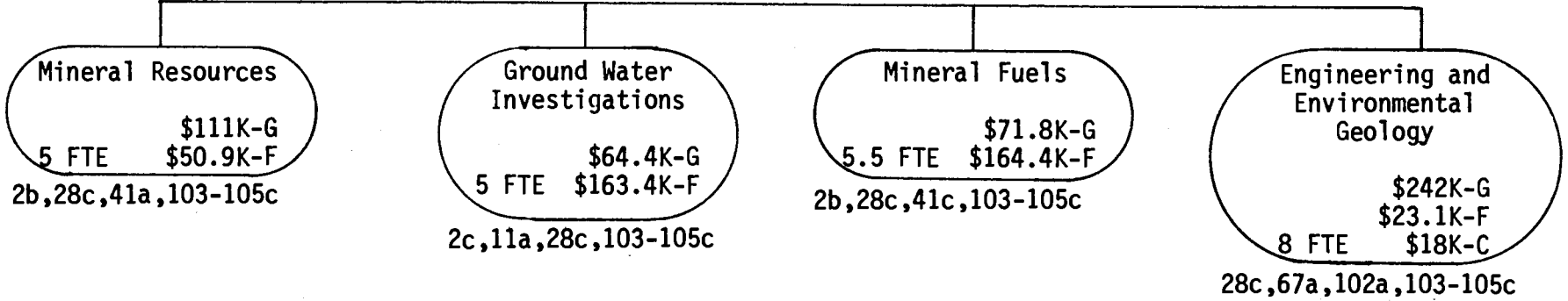

NR-33

Division Totals:

\$696 K-F
\$435 K-G

36 FTE

MINED LAND RECLAMATION DIVISION

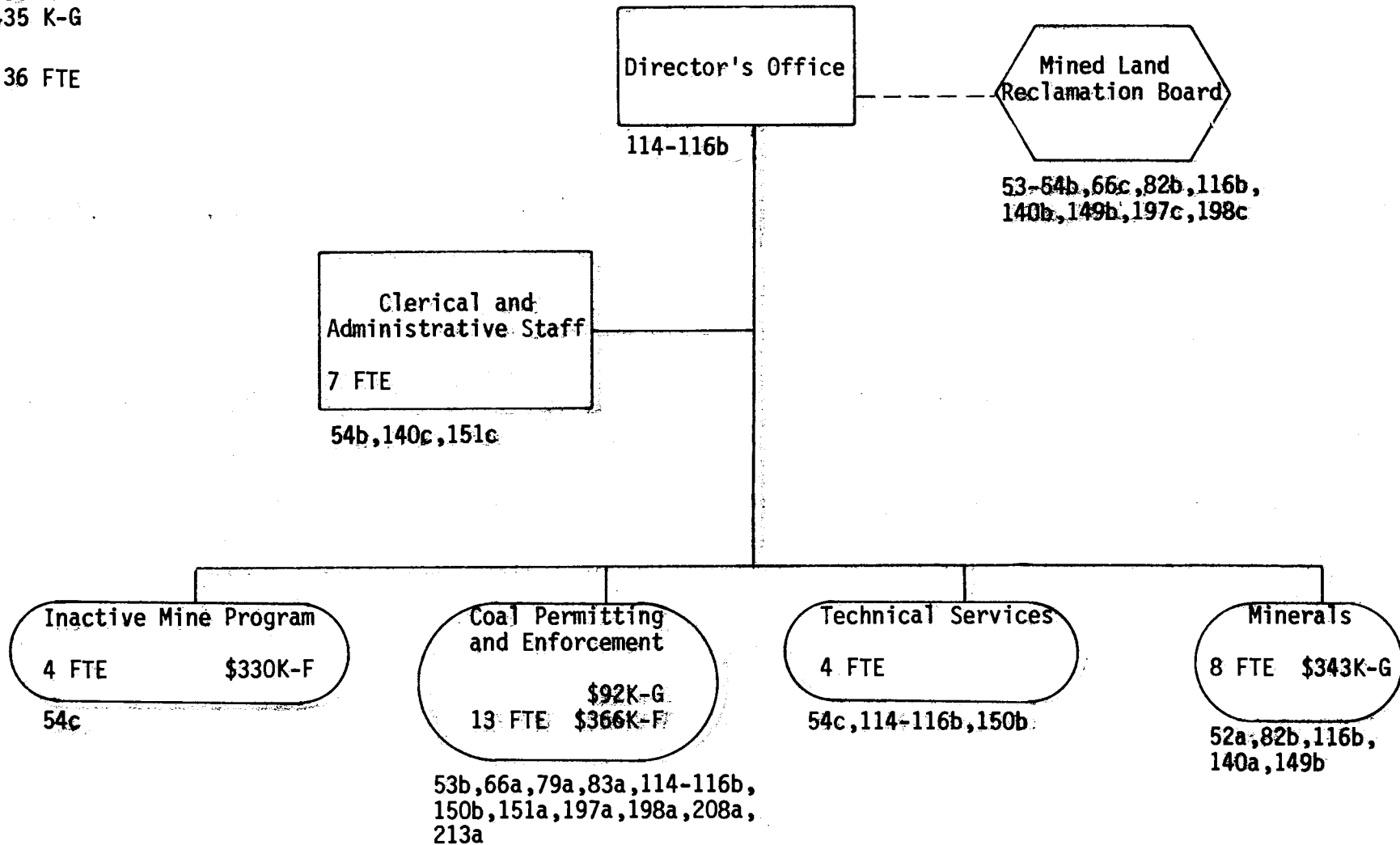

NR-34

Division Totals*

\$64 K-C
\$201 K-G
\$119 K-F

8 FTE

DIVISION OF MINES

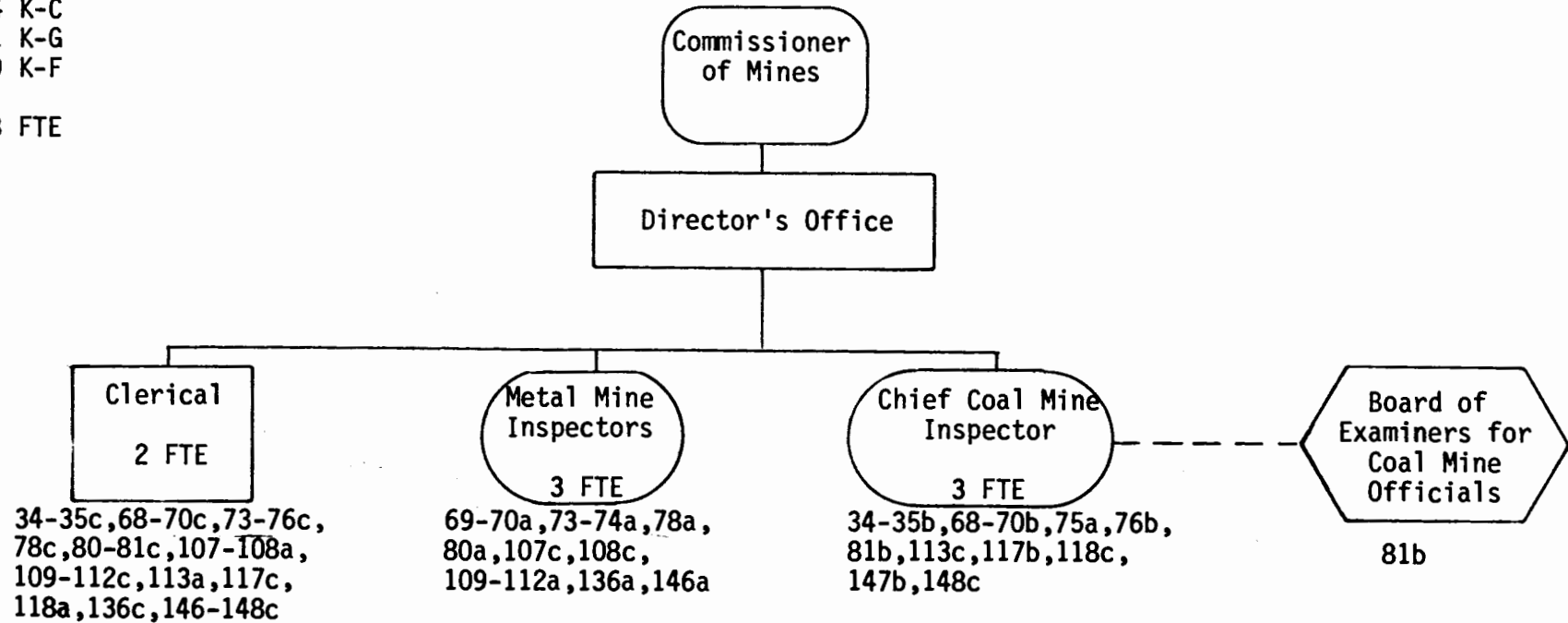

NR-35

* Costs cannot be divided by section. All division costs, except the salaries for inspectors, are figured together.

Commission Totals:

\$494 K-C

14 FTE

OIL AND GAS CONSERVATION COMMISSION

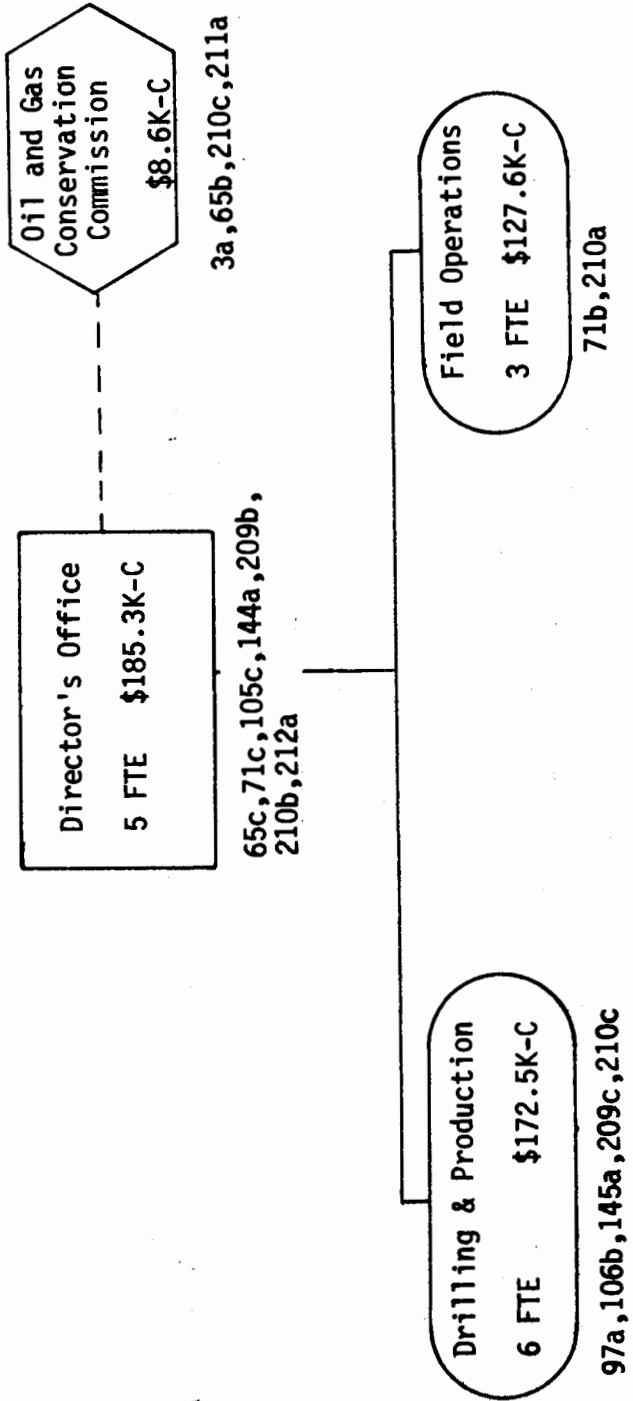

Division Totals:

\$3,436 K-C
 \$1,559 K-G
 \$242 K-F
 142 FTE

DIVISION OF PARKS AND OUTDOOR RECREATION

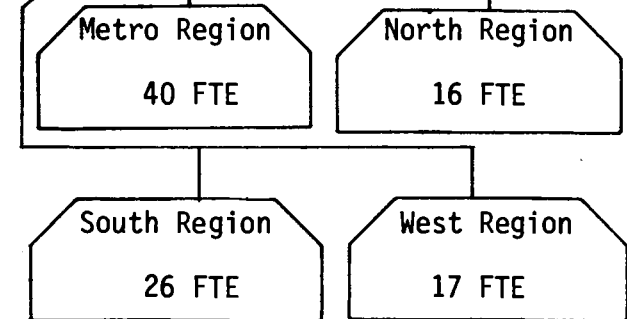
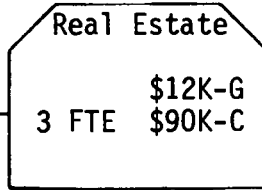
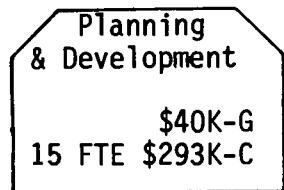
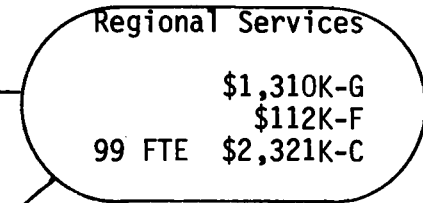
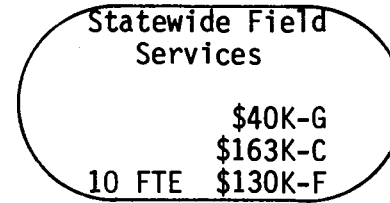
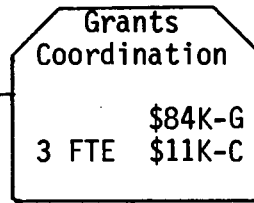
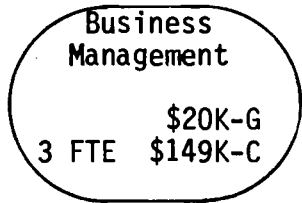
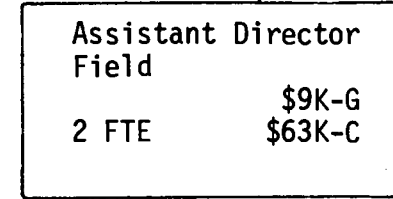
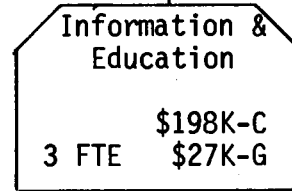
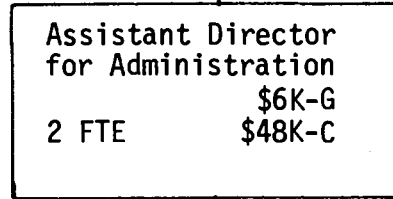
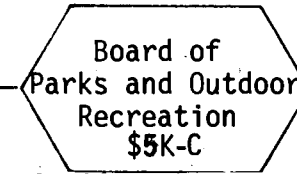
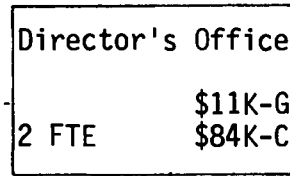
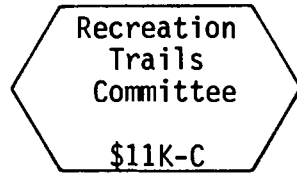

Board Totals:

\$87,756 K-F
\$311,638 K-G
\$29,295 K-C

11 FTE

SOIL CONSERVATION BOARD

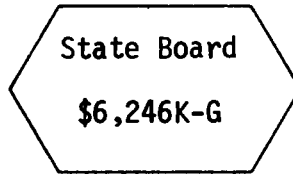

16c,19c,39-40c,57-59c,183-186c,216-221c

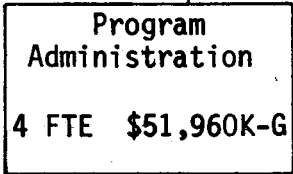

16b,19b,39-40b,57-59b,183-187b,216-221b

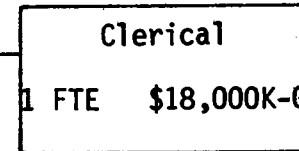
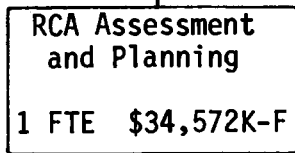
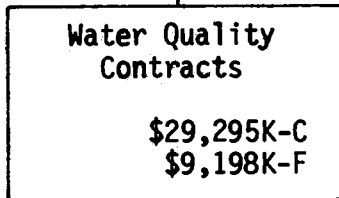
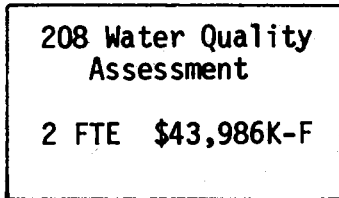

16c,19c,39-40c,57-59c,183-187c,216-221c

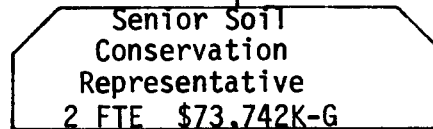
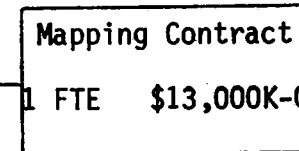

16b,19b,39-40b,57-59b,183-187b,216-221b

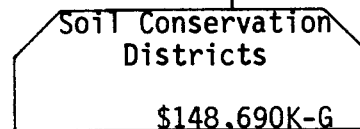

16b,19b,39b,57b,59b,185-187b.

NR-38

Division Totals:

\$653 K-G
 \$135 K-C
 25 FTE

DIVISION OF WATER CONSERVATION

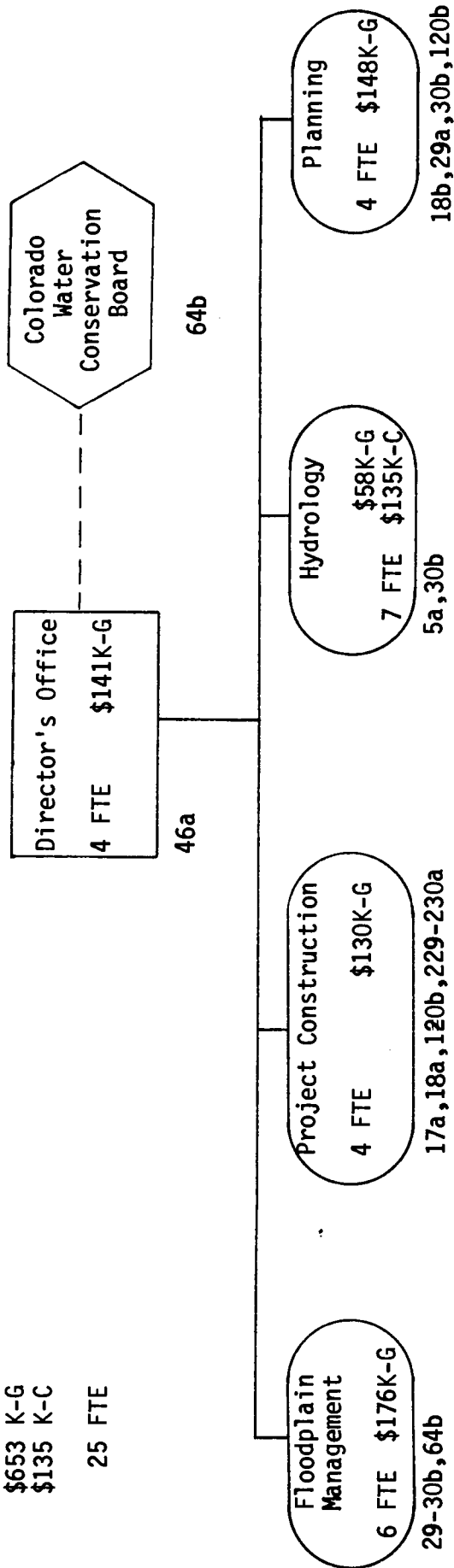

Division Totals:

\$6,339 K-G
 \$37 K-C
 217.2 FTE

DIVISION OF WATER RESOURCES

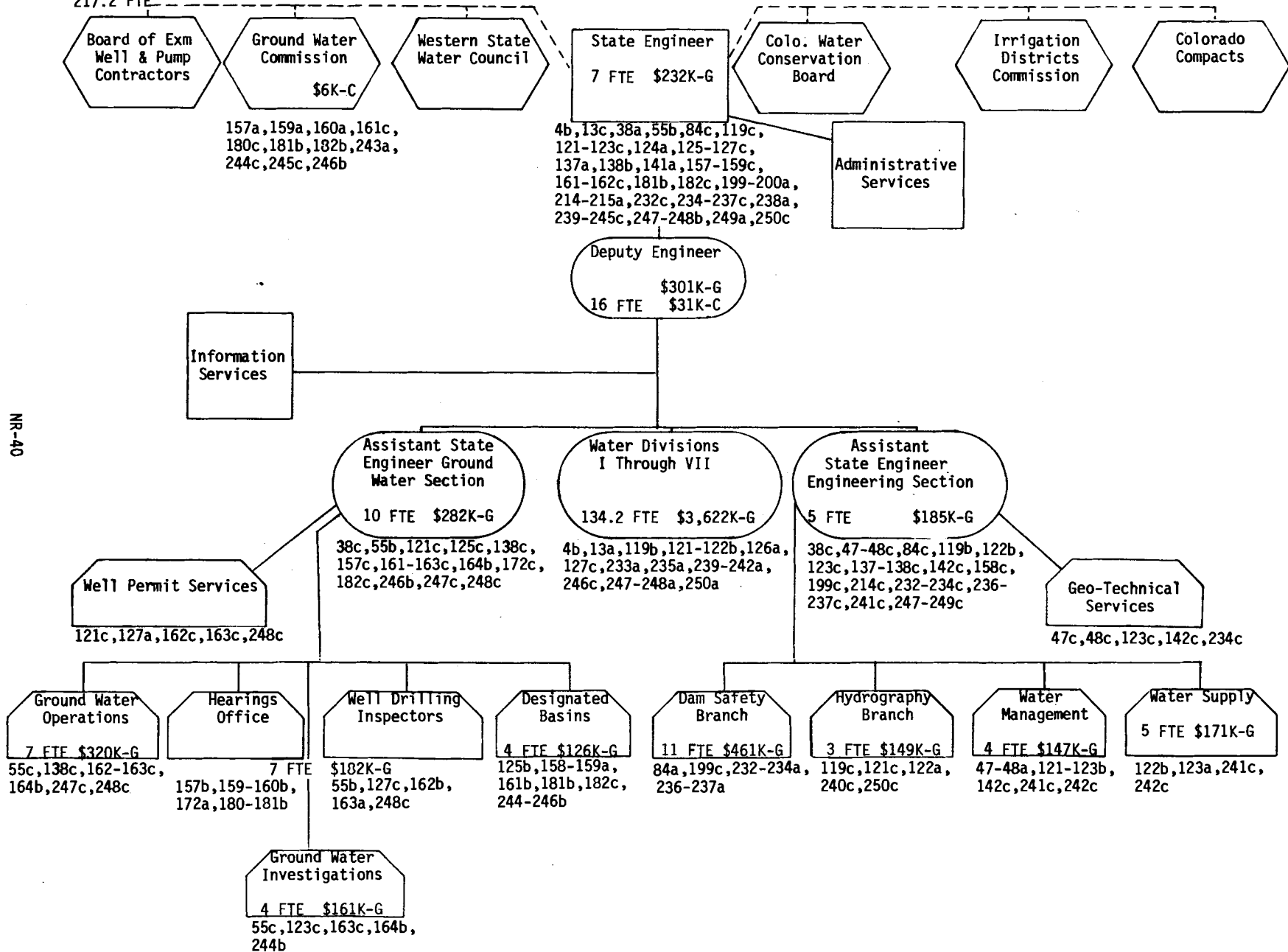

NR-40

Division Totals:

\$20,528.6 K-C
 \$3,633.0 K-F
 \$228.3 K-G

 620.74 FTE

DIVISION OF WILDLIFE

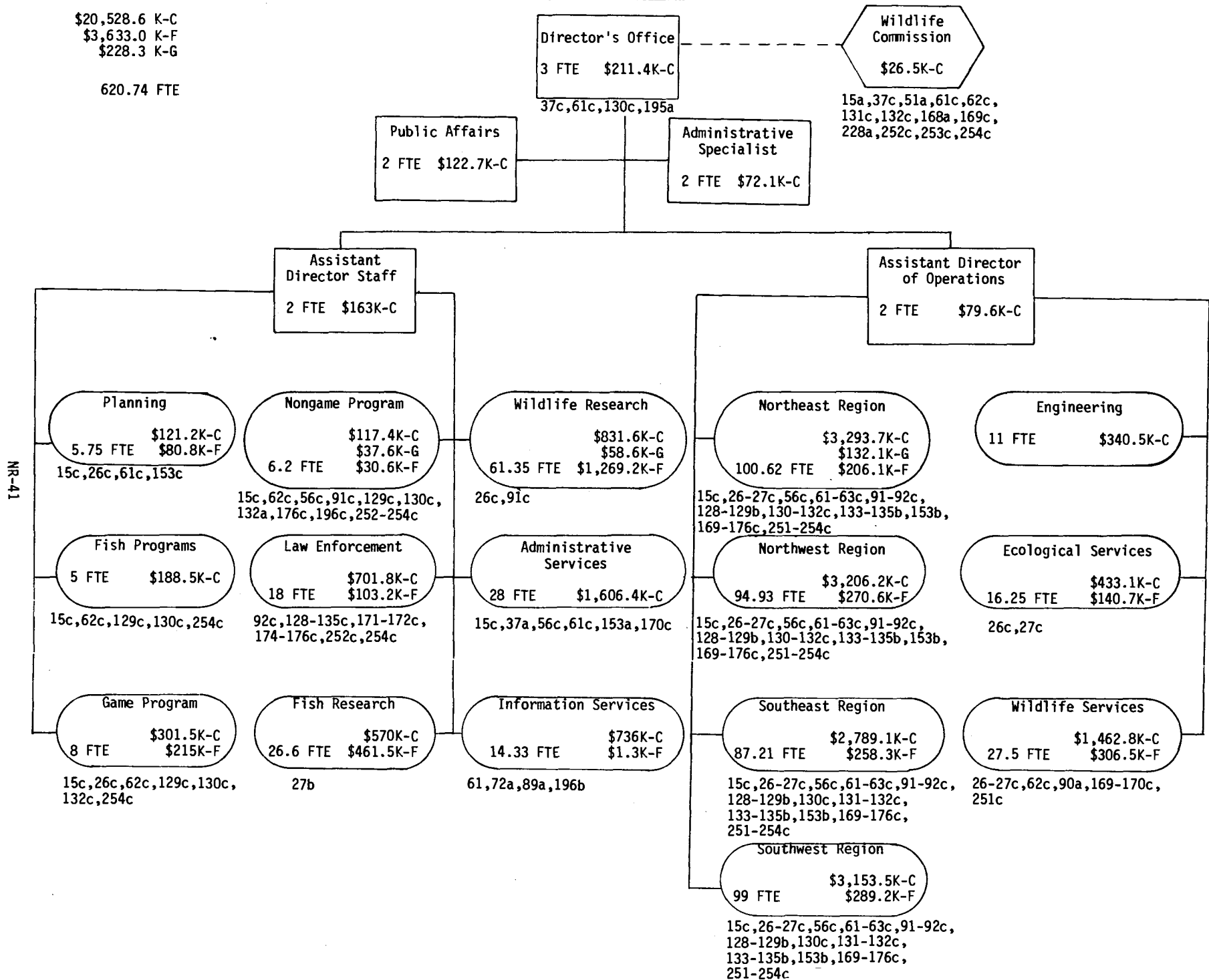

NR-41

DEPARTMENT OF PERSONNEL

Page

Administers the State Personnel System

Administrative Coordination.....	PER-1
Affirmative Action.....	PER-1
Career Development.....	PER-1
Classification and Compensation.....	PER-1
Consultation.....	PER-2
Internal Support Services.....	PER-3
Recruitment.....	PER-4
Training.....	PER-4

Establishes and Enforces Standards
for the State Personnel System

Rule and Regulation Implementation.....	PER-5
---	-------

DEPARTMENT OF PERSONNEL

Administers the State Personnel System

Administrative Coordination

1. Administers the state classified personnel system. (Executive Director's Office; 24-50-101 (c), C.R.S. 1973, Colorado Constitution, Article XII, Sections 13, 14, and 15)
2. Maintains a central personnel data system for all classified state employees. (Information Systems Division; 24-50-127, 128 and 130, C.R.S. 1973)
3. Develops and implements major changes in the state personnel system. (Executive Director's Office; 24-50-102, C.R.S. 1973)

Affirmative Action

4. Works to remove discriminatory barriers in the Colorado State Personnel System and takes measures to assure equal opportunity in all aspects of employment. (Executive Director's Office, Affirmative Action, the United States Constitution (14th Amendment), Colorado State Personnel Board Rules, the Governor's Executive Order of April 5, 1975 and 24-50-101 (3) (a), C.R.S. 1973)

Career Development

5. Develops and implements a statewide career development program. (Technical and Consulting Services Division; 24-50-101 (3) (4), C.R.S. 1973)

Classification and Compensation

6. Groups positions that have comparable duties and responsibilities into classes which are subject to the same descriptive title; defines duties, responsibilities and requirements for filling positions in a class; and maintains the state classification plan. (Compensation/Classification Division; Article XII, Section 11 and Section 13, State Constitution; 24-50-104, C.R.S. 1973; Chapter 2 of the State Personnel Rules and Regulations)
7. Conducts salary and fringe benefits surveys of private industry firms and local governments in Colorado and

government entities of other states.
(Compensation/Classification Division; 25-50-104, C.R.S. 1973; Chapters 3 and 6 of the State Personnel Rules and Regulations)

8. Coordinates new class specifications and regulations with agency personnel officers. (Compensation/Classification Division; 24-50-104 (3) and (4), C.R.S. 1973)

Consultation

9. Provides interpretation of the state personnel rules and regulations to agencies, Department of Personnel staff and individuals. (Information Systems Division; 24-50-101 (3) (c), C.R.S. 1973)
10. Prepares a monthly newspaper distributed to all state classified employees and prepares and distributes a publication which details technical personnel issues to all personnel officers and executive directors. (Executive Director's Office, Public Information; 24-50-102, C.R.S. 1973)
11. Estimates the expenditure impact of proposed legislation. (Executive Director's Office, Policy/Budget; 24-50-102, C.R.S. 1973)
12. Prepares periodic reports for the legislature and other governmental agencies concerning Department of Personnel activities. (Executive Director's Office, Public Information and Policy/Budget; 24-50-102, C.R.S. 1973)
13. Reports to the state treasurer all monies received by the Department of Personnel. (Executive Director's Office, Policy/Budget; 24-50-102, C.R.S. 1973)
14. Coordinates new state personnel rules and regulations with agency executive directors and personnel officers. (Information Systems Division and State Personnel Board; 24-50-101 (3) (b) and (c), C.R.S. 1973)
15. Provides examination guidance or assistance to centralized and decentralized agencies. (Selection Center Division; 24-50-111 through 115, C.R.S. 1973)
16. Conducts personnel officer meetings and disseminates information regarding progress on programs and proposed new programs. (Executive Director's Office, Public Information; 24-30-208 and 24-50-102, C.R.S. 1973)

17. Counsels data system users in the proper use of the system. (Information Systems Division; 24-50-127, 128 and 130, C.R.S. 1973)
18. Cooperates and reciprocates with all state agencies, the private sector, consulting firms and other states and other jurisdictions in the flow of information concerning occupational grouping, analysis and evaluation methods and salary setting criteria. (Compensation/Classification Division; 24-50-104 (2) through (5), C.R.S. 1973; and Chapters 2 and 6 of the Colorado State Personnel Rules and Regulations)
19. Coordinates performance appraisal, management certification training program, training, post-audits and affirmative action with all agency personnel officers. (Technical and Consulting Services Division; 24-50-101 (3) (a), (c), and (d), 24-50-118 (1), 24-50-122, and 24-50-203, C.R.S. 1973)
20. Provides personnel services to small non-decentralized agencies and local governments. (Technical and Consulting Services Division; 24-50-102 (9), 24-50-104, and 24-50-111 through 115, C.R.S. 1973)

Internal Support Services

21. Directs the staff and operations of the Department of Personnel. (Executive Director's Office and Deputy Director; 24-1-107 and 24-50-102, C.R.S. 1973)
22. Maintains an accounting of the expenditures in the department's appropriation. (Executive Director's Office, Policy/Budget; 24-50-102, C.R.S. 1973)
23. Processes and pays all obligations incurred by the department. (Executive Director's Office, Policy/Budget; 24-50-102 (c), C.R.S. 1973)
24. Prepares the department's budget for submission to the general assembly. (Executive Director's Office, Policy/Budget; 24-50-102, C.R.S. 1973)
25. Processes the payroll for the department. (Executive Director's Office, Policy/Budget; 24-50-102, C.R.S. 1973)
26. Maintains records of fixed assets and consumable inventories acquired by the department. (Executive Director's Office, Policy/Budget; 24-50-102, C.R.S. 1973)
27. Briefs employees on insurance, retirement, fund drives and health and safety matters. (Executive Director's Office, Policy/Budget; no statutory authorization)

28. Conducts orientation sessions and other training. (Executive Director's Office, Policy/Budget; 24-50-102 and 24-50-122, C.R.S. 1973)
29. Maintains personnel records of all departmental employees. (Executive Director's Office, Policy/Budget; 24-30-208 and 24-50-102, C.R.S. 1973)
30. Conducts classification audits of positions in the department. (Compensation/Classification Division; 24-50-102, C.R.S. 1973)
31. Conducts examinations for vacant or reallocated positions in the department. (Selection Center Division; 23-50-111 through 115, C.R.S. 1973)
32. Designs, revises and executes the department's computer support. (Information Systems Division; 24-50-127, 128, and 130, C.R.S. 1973)
33. Provides post-audit reviews of the operation and management of the state personnel system. (Technical and Consulting Services Division; 24-50-101 (3) (d), C.R.S. 1973)
34. Conducts hearings regarding appeals applicable to classification actions, tests, salaries and fringe benefits. (Executive Director's Office, Appeals; 24-50-101 (3) (b), 24-50-104 (5) (c) (II), 24-50-123, and 24-50-125, C.R.S. 1973)

Recruitment

35. Provides a central service for state and national recruitment efforts which includes publication and distribution of announcements for job openings, outreach recruiting for affirmative action purposes and labor market conditions. (Selection Center Division; 24-50-112, C.R.S. 1973)
36. Provides examination and referral services for classified positions to all state agencies. (Selection Center Division; 24-50-111 through 115, C.R.S. 1973)
37. Develops tests to assist in evaluating applicants who wish to work for the state. (Selection Center Division; 24-50-101 (1), C.R.S. 1973)

Training

38. Provides training coordination and administration to state agencies. (Technical and Consulting Services Division; 24-50-118 (1), 24-50-122, and 24-50-203, C.R.S. 1973)
39. Trains personnel analysts in decentralized agencies to assure consistency in classification decisions. (Compensation/Classification Division; 24-50-104 (3) and (4), C.R.S. 1973; and Chapter 2 of the Colorado State Personnel Rules and Regulations)

Establishes and Enforces Standards for the State Personnel System

Rule and Regulation Implementation

40. Adopts, amends, or repeals state personnel rules and regulations to implement Sections 13, 14, and 15 of Article XII of the State Constitution and laws enacted pursuant thereto. (State Personnel Board; 24-50-103, C.R.S. 1973)
41. Utilizes hearing officers and such personnel as necessary for adjudication of appeals and grievances from classified employees. (State Personnel Board; 24-50-103 (7), C.R.S. 1973)
42. Approves or denies requests from state agencies for waiver of residency requirement in order to permit nationwide employment recruitment. (State Personnel Board; Rule 4-3-1, Colorado State Personnel Rules and Regulations, Colorado Constitution Article XII, Section 15)

Department Totals:

\$2,734 K-G
 114 K-C
 46 K-F
 78.7 FTE

DEPARTMENT OF PERSONNEL

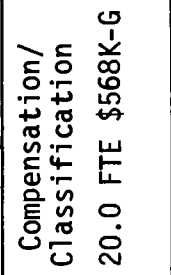
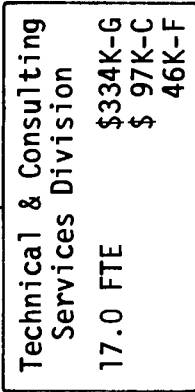
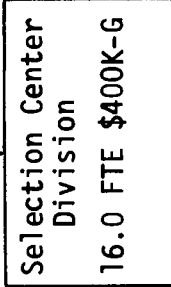
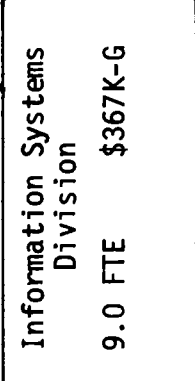
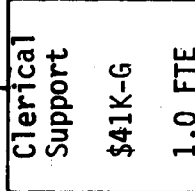
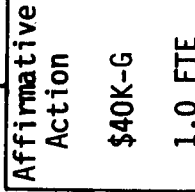
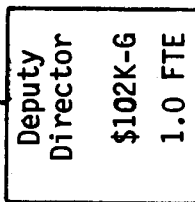
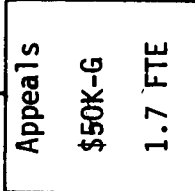
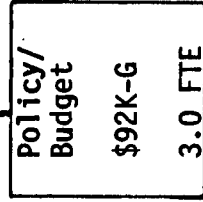
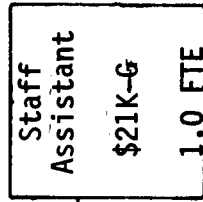
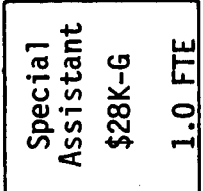
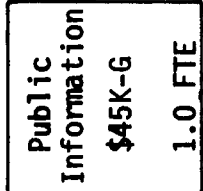
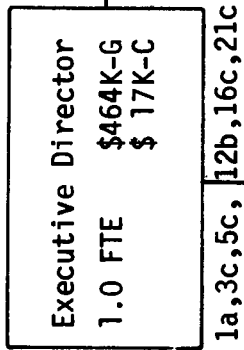
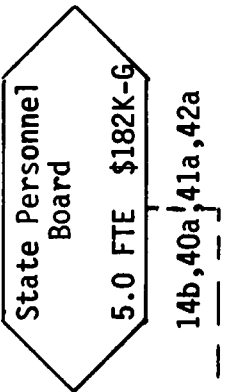

DEPARTMENT OF REGULATORY AGENCIES

	<u>Page</u>
<u>Regulates Occupations, Professions, and Certain Companies</u>	
Conducts the Credentialing of Companies and Individuals.....	RA-1
Credentialing of Companies.....	RA-1
Credentialing of Individuals.....	RA-4
Reciprocity.....	RA-7
Conducts Investigations and Hearings Concerning the Actions of Credentialed Companies and Individuals.....	RA-8
Companies.....	RA-8
Individuals.....	RA-10
Promulgates Rules and Regulations and Conducts Other Supervisory Activities over Credentialed Companies and Individuals.....	RA-12
Audits and Reports.....	RA-12
Companies.....	RA-14
Mergers and Liquidations.....	RA-23
Individuals.....	RA-24
Provides Coordinated Internal Support and Management.....	RA-27
Provides Corrective Actions Against Credentialed Companies and Individuals.....	RA-28
Companies.....	RA-28
Fees and Fines.....	RA-28
Judicial Proceedings.....	RA-29
Orders.....	RA-31
Revocations and Suspensions.....	RA-32
Individuals.....	RA-36
Fees and Fines.....	RA-36
Judicial Proceedings.....	RA-37
Orders.....	RA-39
Revocations and Suspensions.....	RA-40

DEPARTMENT OF REGULATORY AGENCIES

Regulates Occupations, Professions and Certain Companies

Conducts the Credentialing of Companies and Individuals

Credentialing of Companies

1. Issues licenses to liability insurance companies. (Division of Insurance, Investigating and Licensing Section; 10-12-204, C.R.S. 1973)
2. Issues licenses to insurance rating organizations. (Division of Insurance, Investigating and Licensing Section; 10-4-206 and 10-4-306, C.R.S. 1973)
3. Certifies life care institutions. (Division of Insurance, Financial Examinations Section; 12-13-102 through 12-13-104, C.R.S. 1973)
4. Registers motor vehicle carriers engaged in interstate transportation of persons or property for compensation on the state's public highways. (Public Utilities Commission, Administrative and Transportation Sections; 40-10-120, C.R.S. 1973)
5. Registers contract motor carriers. (Public Utilities Commission, Administrative and Transportation Sections; 40-11-103 through 40-11-105 and 40-11-115, C.R.S. 1973)
6. Grants permits to commercial carriers. (Public Utilities Commission; 40-12-102 through 40-12-104, C.R.S. 1973)
7. Issues permits to towing carriers. (Public Utilities Commission, Administrative and Transportation Sections; 40-13-102, C.R.S. 1973)
8. Grants licenses for the operation of race meets for dogs and horses. (Division of Racing, Administrative, Greyhound and Horse Racing Sections; 12-60-106 and 12-60-107, C.R.S. 1973)
9. Grants licenses to conduct the racing of standard bred harness horses. (Division of Racing, Executive Secretary; 12-60-114, C.R.S. 1973)
10. Contracts with persons, firms, corporations or associations to conduct sweepstakes races. (Division of Racing, Executive Secretary; 12-60.1-103, C.R.S. 1973)

11. Registers companies providing preowned home warranty service contracts. (Division of Real Estate, Commissioners, Auditing Section; 12-61-603 and 12-61-605, C.R.S. 1973)
12. Registers passenger tramways and approves construction of new tramways or major modification of existing ones. (Division of Registrations, Board of Passenger Tramway; 25-5-705 and 706, C.R.S. 1973)
13. Issues certificates of public convenience for motor vehicle carriers. (Public Utilities Commission, Administrative Section; 40-10-105, C.R.S. 1973)
14. Issues certificates of authority for the writing of interinsurance contracts. (Division of Insurance, Office of the Commissioner, Investigating and Licensing and Policy Analysis and Service Sections; 10-13-106, C.R.S. 1973)
15. Enforces the "Antibucketing (illegal securities transactions) Law". (Division of Securities, Enforcement Section; 11-53-103 through 105, C.R.S. 1973)
16. Exercises general authority over the exempting of motor vehicle transportation provided on a nonprofit basis and volunteer transportation. (Public Utilities Commission, Executive Secretary, and Transportation Section; 40-1.1-101, C.R.S. 1973)
17. Licenses, regulates, and supervises all race meets with pari-mutuel wagering held in Colorado. (Racing Commission, Administrative Section; 12-60-104, C.R.S. 1973)
18. Receives and reviews applications for charter of incorporation as a bank or trust company. (Division of Banking, Director and Deputy Director; 11-3-106 and 109, and 11-23-105, C.R.S. 1973)
19. Reviews proposals for the formation of a self-insurance pool and conducts examinations of such pools. (Division of Insurance, Commissioner's Office and Financial Examinations Section; 8-44-110 (5) through (7), 24-10-115.5 (3) and (5), C.R.S. 1973)
20. Receives and reviews applications for licenses as a mutual insurance company. (Division of Insurance, Commissioner's Office; 10-12-204, C.R.S. 1973)
21. Conducts examinations of the Colorado Insurance Guaranty Association. (Division of Insurance, Financial Examinations Section; 10-4-514, C.R.S. 1973)

22. Receives and reviews applications for licenses by motor clubs. (Division of Insurance, Commissioner's Office; 12-53-102, 12-53-103, and 12-53-104 (1), C.R.S. 1973)
23. Receives and reviews applications for licensure of life care institutions. (Division of Insurance, Commissioner's Office and Financial Examinations Section; 12-13-102, 103 (1), and 104, C.R.S. 1973)
24. Receives and reviews applications for licensure of cemeteries. (Division of Insurance, Investigating and Licensure Section; 12-12-107, C.R.S. 1973)
25. Receives and reviews applications for certificates of authority for nonprofit medical services. (Division of Insurance, Commissioner's Office and Financial Examinations Section; 10-16-112, C.R.S. 1973)
26. Receives and reviews applications for licenses as an agent or seller of preneed funeral contracts. (Division of Insurance, Commissioner of Insurance; 10-15-105, 113, C.R.S. 1973)
27. Receives and reviews applications for licenses as a fraternal benefit society. (Division of Insurance, Commissioner's Office and Financial Examinations Section; 10-14-116 and 117, C.R.S. 1973)
28. Receives and reviews registrations for motor vehicle carriers to operate in this state. (Public Utilities Commission, Executive Secretary's Office and Transportation Section; 40-10-120, C.R.S. 1973)
29. Receives and reviews registrations and applications for permits to operate as a contract motor carrier in the state. (Public Utilities Commission, Executive Secretary's Office and Transportation Section; 40-11-103 and 115, C.R.S. 1973)
30. Receives and reviews applications for permits to operate as a towing motor carrier. (Public Utilities Commission, Administrative and Transportation Sections; 40-13-103 through 40-13-106, C.R.S. 1973)
31. Receives and reviews applications for registrations as a developer of subdivisions. (Division of Real Estate, Education and Licensing Section; 12-61-403, 404, C.R.S. 1973.)
32. Receives and reviews applications for registration as a partnership or professional corporation engaged in public accounting. (Division of Registrations, State Board of Accountancy; 12-2-118, C.R.S. 1973)

33. Receives and reviews applications for registration as a partnership or professional corporation engaged in the practices of architecture. (State Board of Examiners of Architects; 12-4-110, C.R.S. 1973)
34. Receives and reviews applications for accreditation as a psychiatric technician educational program, surveys the institution and periodically examines the program. (Division of Registrations, State Board of Nursing; 12-42-111, C.R.S. 1973)
35. Receives and reviews applications for certification as a savings and loan association, for license to establish a branch, for authority to accomplish a merger, consolidation or transfer, for a permit to sell permanent stock, and to gain designation as an eligible public depository. (Division of Savings and Loan, Commissioner and Examination Section; 11-41-109, 120, and 121, 11-42-112, and 11-47-105, C.R.S. 1973)

Credentialing of Individuals

36. Issues licenses to insurance agents and insurance adjusters. (Division of Insurance, Investigating and Licensing Section; 10-2-102 and 204, C.R.S. 1973)
37. Issues licenses to insurance solicitors. (Division of Insurance, Investigating and Licensing Section; 10-13-102, C.R.S. 1973)
38. Licenses surplus line insurance brokers. (Insurance Commissioner's Office, Investigation and License Section, and Financial Examination and Policy Analysis Sections; 10-5-106, C.R.S. 1973)
39. Licenses motor club representatives. (Division of Insurance, Office of the Commissioner; 12-53-107 and 108, C.R.S. 1973)
40. Grants licenses to representatives or agents of nonprofit hospitals and health service corporations. (Division of Insurance, Investigating and Licensing Section; 10-16-118 and 119, C.R.S. 1973)
41. Licenses agents who accept funds for preneed funeral contracts. (Division of Insurance; 10-15-105, 10-15-112 and 113, and 12-12-107, C.R.S. 1973)
42. Licenses agents representing fraternal benefit societies. (Division of Insurance, Investigating and Licensing Section; 10-14-116, C.R.S. 1973)

43. Licenses bail bondsmen. (Division of Insurance, Investigating and Licensing Section; 12-7-102 through 104, C.R.S. 1973)
44. Issues licenses to real estate brokers and salesmen. (Division of Real Estate, Commissioners, Administrative, Education and Licensing Sections; 12-61-102 through 12-61-104, 12-61-107 through 12-61-108, and 12-61-110, C.R.S. 1973)
45. Registers subdivision developers. (Division of Real Estate, Education and Licensing Section; 12-61-404, C.R.S. 1973)
46. Licenses abstractors. (Division of Registrations, Board of Abstractors; 12-1-104, C.R.S. 1973)
47. Examines and issues certificates for certified public accountants. (Division of Registrations, Board of Accountancy; 12-2-108 through 12-2-111, C.R.S. 1973)
48. Examines and licenses architects. (Division of Registrations, Board of Architects; 12-4-107 and 108, C.R.S. 1973)
49. Examines and licenses barbers and cosmetologists. (Division of Registrations, Board of Barbers and Cosmetology; 12-8-108, C.R.S. 1973)
50. Examines and licenses chiropractors. (Division of Registrations, Board of Chiropractic Examiners; 12-33-112 through 114, C.R.S. 1973)
51. Examines and licenses dentists, dental hygienists and dental auxiliaries. (Division of Registrations, Board of Dental Examiners; 12-35-113 and 123, C.R.S. 1973)
52. Examines and licenses electricians. (Division of Registrations, State Electrical Board; 12-23-106, C.R.S. 1973)
53. Examines and licenses engineers. (Division of Registrations, Board of Registration for Professional Engineers and Professional Land Surveyors; 12-25-110, C.R.S. 1973)
54. Examines and licenses surveyors. (Division of Registrations, Board of Registration for Professional Engineers and Professional Land Surveyors; 12-25-202 through 205 and 209, C.R.S. 1973)
55. Examines and licenses hearing aid dealers. (Division of Registrations, Board of Hearing Aid Dealers; 12-65-105 through 107, C.R.S. 1973)

56. Examines and licenses persons practicing medicine, podiatry and as child health associates. (Division of Registrations, Board of Medical Examiners; 12-32-102, 12-36-107, and 12-31-105, C.R.S. 1973)
57. Examines and issues licenses to mobile home dealers and salesmen. (Division of Registrations, Board of Mobile Home Dealers; 12-51.5-107, C.R.S. 1973)
58. Examines and licenses persons practicing mortuary science. (Division of Registrations, Board of Mortuary Science; 12-54-109, C.R.S. 1973)
59. Examines and licenses persons practicing professional nursing. (Division of Registrations, Board of Nursing; 12-38-212, C.R.S. 1973)
60. Examines and licenses nursing home administrators. (Division of Registrations, Board of Examiners of Nursing Home Administrators; 12-39-102, 105, and 107, C.R.S. 1973)
61. Examines and licenses practical nurses. (Division of Registrations, Board of Nursing; 12-38-111, C.R.S. 1973)
62. Examines and licenses optometrists. (Division of Registrations, Board of Optometric Examiners; 12-40-107, C.R.S. 1973)
63. Examines and licenses pharmacists. (Division of Registrations, Board of Pharmacy; 12-22-111 and 112, and 12-22-304, C.R.S. 1973)
64. Examines and licenses physical therapists. (Division of Registrations, Board of Physical Therapy; 12-41-108 and 112, C.R.S. 1973)
65. Examines and licenses plumbers. (Division of Registrations, Examining Board of Plumbers; 12-58-107, C.R.S. 1973)
66. Examines and licenses psychiatric technicians. (Division of Registrations, Board of Nursing; 12-42-104, C.R.S. 1973)
67. Examines and licenses psychologists. (Division of Registrations, Board of Psychologist Examiners; 12-43-109, C.R.S. 1973)
68. Examines and licenses social workers. (Division of Registrations, Board of Social Workers; 12-63.5-106, C.R.S. 1973)

69. Examines, licenses, and regulates veterinarians. (Division of Registrations, Board of Veterinary Medicine; 12-64-105, C.R.S. 1973)
70. Licenses broker dealers and issuer dealers of securities sold in the state. (Division of Securities, Examining and Licensing Section; 11-51-105 and 110, C.R.S. 1973)
71. Administers examinations to each applicant for a license as an adjuster and requires insurers to report termination of licensees. (Division of Insurance, Investigating and Licensing Section; 10-2-106 and 10-2-216, C.R.S. 1973)
72. Receives and reviews applications for licensing and registration as insurance adjuster, agent or broker. (Division of Insurance, Financial and Examination Section; 10-2-103 through 106, 10-2-201, 205, 207, and 209, C.R.S. 1973)
73. Receives and reviews applications for license as a real estate broker or salesperson. (Division of Real Estate, Administrative, Education and Licensing Sections; 12-61-104, C.R.S. 1973).
74. Receives and reviews applications for registration as a broker or dealer in securities. (Division of Securities, Examining and Licensing Section; 11-51-105 through 107, C.R.S. 1973)

Reciprocity

75. Issues in its discretion, certificates of certified public accountants under reciprocity agreements. (Division of Registrations, Board of Accountancy, Enforcement Section; 12-2-113, C.R.S. 1973)
76. Issues or endorses chiropractic licenses properly issued in other states and still valid. (Division of Registrations, State Board of Chiropractic Examiners; 12-33-113, C.R.S. 1973)
77. Endorses a nursing home administrator's license issued in another state. (Division of Registrations, Board of Examiners of Nursing Homes Administrators; 12-39-110, C.R.S. 1973)
78. Exercises reciprocity agreements for the licensure of electricians. (Division of Registrations, State Electrical Board, 12-23-109, C.R.S. 1973)
79. Waives examination requirements and issues a certificate of certified public accountancy to qualified applicants.

(Division of Registrations, Board of Accountancy; 12-2-113, C.R.S. 1973)

80. Waives examination requirements and issues a license to any chiropractor so entitled. (Division of Registrations, Board of Chiropractic Examiners; 12-33-113, C.R.S. 1973)
81. Waives written examinations and issues licenses to electricians licensed by other states having requirements equivalent to those of Colorado. (Division of Registrations, State Electrical Board; 12-23-109, C.R.S. 1973)
82. Issues a license, upon examination, to anyone licensed to practice mortuary science in another state with similar requirements to those of Colorado. (Division of Registrations, Board of Mortuary Science; 12-54-113, C.R.S. 1973)
83. Issues a license to anyone licensed as a plumber in another state with equivalent requirements. (Division of Registrations, Examining Board of Plumbers; 12-58-114, C.R.S. 1973)

Conducts Investigations and Hearings Concerning the Actions of Credentialed Companies and Individuals

Companies

84. Investigates and conducts hearings as part of the regulation of the insurance industry in the state. (Division of Insurance, Policy Analysis and Service Section and Commission's Office; 10-1-110, C.R.S. 1973)
85. Investigates complaints and conducts hearings regarding any rate charged, rating plan, rating system, or underwriting rule followed or adopted by an insurer or rating organization. (Division of Insurance; 10-4-403, C.R.S. 1973)
86. Holds hearings and issues subpoenas in connection with alleged violations of the laws concerning banking. (Division of Banking, Deputy Director, Administrative Section, Public Deposits Protection Act Section, Commercial and Industrial Bank Unit, Electronic Data Processing and Electric Funds Transfers System Unit Examination Section; 11-2-103 (3) and 104, C.R.S. 1973)
87. Conducts investigations of the financial condition, affairs and management of an insurance company in connection with violations of the insurance laws of Colorado. (Division of Insurance, Commissioner's Office,

and Financial Examinations Section; 10-1-108 (5) and 10-1-111, C.R.S. 1973)

88. Conducts investigations of the financial condition, affairs and management of any captive insurance company operating under the laws of this state. (Division of Insurance, Commissioner's Office; 10-6-120 (1), C.R.S. 1973)
89. Investigates and holds hearings on complaints of violations of the laws concerning motor clubs. (Division of Insurance, Investigating and Licensing Sections as well as Financial Examinations Section; 12-53-105 (2) (a) and 12-53-106)
90. Examines the financial affairs of nonprofit hospitals operating in the state and investigates any complaint against such institution. (Division of Insurance, Office of the Commissioner, Financial Examinations, Policy Analysis and Service Sections; 10-16-120, 10-16-122, C.R.S. 1973)
91. Investigates complaints against public utilities under its jurisdiction and holds hearings regarding such matters. (Public Utilities Commission, Hearing Examiners, Fixed Utilities, Transportation Sections; 40-6-108 through 110, C.R.S. 1973)
92. Investigates complaints against corporations operating motor vehicle carriers in the state and holds hearings regarding such matters. (Public Utilities Commission, Transportation and Hearing Examiners Sections; 40-6-108, C.R.S. 1973)
93. Investigates complaints filed by railroad employees against their employers and conducts hearings regarding such matters. (Public Utilities Commission, Office of Executive Secretary, Hearing Examiners Section; 40-29-112, C.R.S. 1973)
94. Investigates complaints filed against race meet licensees and conducts hearings regarding such matters. (Division of Racing, Commission, and Administrative Section; 12-60-105.5 and 105.6 C.R.S. 1973)
95. Investigates complaints filed against real estate companies licensed in the state and conducts hearings regarding such matters. (Division of Real Estate, Investigations and Auditing Sections, and Real Estate Commission; 12-61-113 and 114, C.R.S. 1973)
96. Investigates complaints filed against subdivision development companies and pre-owned warranty companies

- licensed in the state and conducts hearings regarding such matters. (Division of Real Estate, Investigations, Auditing and Education and Licensing Sections; 12-61-405 and 406, 12-61-606 through 608, C.R.S. 1973)
97. Investigates complaints filed against accounting firms licensed in the state and conducts hearings regarding such matters. (Division of Registrations, Board of Accountancy; 12-2-125 and 126, C.R.S. 1973)
98. Conducts hearings on violation of the regulations promulgated by the commission regarding the operation of railroads. (Public Utilities Commission, Executive Secretary, and Transportation and Hearing Examiners Sections; 40-29-112, C.R.S. 1973)
99. Examines the business affairs of savings and loan associations operating in the state and when necessary, conducts audits of them. (Division of Savings and Loan, Commissioner's Office and Examination Section; 11-44-109, C.R.S. 1973)
100. Confers or holds joint hearings with the authorities of any state or any agency of the United States regarding public utilities. (Public Utilities Commission, Executive Secretary, Administrative, Transportation and Fixed Utilities Sections; 40-2-115, C.R.S. 1973)
101. Inspects electrical installation in new construction, remodeling or repair work. (Division of Registrations, State Electrical Board; 12-23-116, C.R.S. 1973)

Individuals

102. Conducts investigations and hearings upon complaints of unfair employment practices against individuals. (Division of Civil Rights, Administrative, Regional Office, and Research and Education Sections; 24-34-306 and 402, C.R.S. 1973)
103. Conducts investigations and hearings upon complaints of unfair housing practices against individuals. (Division of Civil Rights, Administrative, Regional Office, and Research and Education Sections; 24-34-306, 24-34-504, 506 through 508, C.R.S. 1973)
104. Conducts investigations and hearings upon complaints of discrimination in public accommodations against individuals. (Division of Civil Rights, Administrative, Regional Office, and Research and Education Sections; 24-34-306 and 24-34-601 through 605, C.R.S. 1973)

105. Conducts investigations and hearings upon complaints of denial of or interference with the rights of blind and handicapped persons. (Division of Civil Rights, Administrative, Regional Office, and Research and Education Sections; 24-34-306, 801 and 802, C.R.S. 1973)
106. Conducts investigations and hearings upon complaints of discriminatory advertising by individuals. (Division of Civil Rights, Administrative, Regional Office, and Research and Education Sections; 24-34-306, 701 through 707, C.R.S. 1973)
107. Conducts hearings and investigates complaints against railroad employees charged with violations of commission regulations. (Public Utilities Commission, Executive Secretary; 40-32-110, C.R.S. 1973)
108. Conducts hearings and investigates complaints against any licensee or person on the premises of a race track charged with violating commission regulations. (Division of Racing, Commission; 12-60-105.5 and 105.6, C.R.S. 1973)
109. Conducts hearings and investigates complaints against real estate brokers and salesmen charged with violating commission regulations. (Division of Real Estate, Investigations Section; 12-61-113 and 114, C.R.S. 1973)
110. Conducts hearings and investigates any certified public accountant charged with violating state laws and board regulations. (Division of Registrations, Investigations Section and Board of Accountancy; 12-2-125 and 126, C.R.S. 1973)
111. Conducts hearings and investigates complaints against architects charged with violating state laws and board regulations. (Division of Registrations, Investigations Section and Board of Architects; 12-4-115 and 12-4-120, C.R.S. 1973)
112. Conducts hearings and investigates complaints against chiropractors. (Division of Registrations, Investigations Section and Board of Chiropractic Examiners; 12-33-119, C.R.S. 1973)
113. Conducts hearings and investigates complaints against hearing aid dealers licensed in the state. (Division of Registrations, Board of Hearing Aid Dealers and Investigations Section; 12-65-115, C.R.S. 1973)
114. Conducts hearings and investigates complaints against nurses licensed in the state. (Division of Registrations, Board of Nursing and Investigations Section; 12-38-108 (h), C.R.S. 1973)

115. Conducts hearings and investigates complaints against persons licensed as practical nurses in the state. (Division of Registrations, Board of Nursing and Investigations Section; 12-38-119.7, C.R.S. 1973)
116. Conducts hearings and investigates complaints against veterinarians licensed in the state. (Division of Registrations, Board of Veterinary Medicine and Investigations Section; 12-64-111, C.R.S. 1973)
117. Conducts hearings and investigates complaints against broker-dealers or issuer-dealers licensed in the state. (Division of Securities, Examining and Licensing Section and Enforcement Section; 11-51-111, C.R.S. 1973)
118. Investigates complaints filed against barbers and cosmetologists licensed in the state and conducts hearings regarding such matters. (Division of Registrations, Board of Barbers and Cosmetology; 12-8-129, C.R.S. 1973)
119. Investigates and brings legal action against engineers violating state regulations. (Division of Registrations, Board of Registration for Professional Engineers and Professional Land Surveyors; 12-25-117 and 12-25-121, C.R.S. 1973)
120. Conducts hearings on charges of fraud, deceit, negligence, incompetency, or misconduct against a registered engineer or surveyor. (Division of Registrations, Investigations Section and Board of Registration for Professional Engineers and Surveyors; 12-25-211, C.R.S. 1973)

Promulgates Rules and Regulations and Conducts Supervisory Activities over Credentialed Individuals and Companies

Audits and Reports

121. Assures that bondsmen make a semiannual report of their business. (Division of Insurance, Investigating and Licensing Section; 12-7-105, C.R.S. 1973)
122. Prepares an annual report accounting for the efficient discharge of the duties assigned by law to the board of abstractors. (Division of Registrations, Abstractors, Board of Examiners; 12-1-116, C.R.S. 1973)
123. Prepares an annual report accounting for the discharge of duties delegated by law to the board of optometric examiners. (Division of Registrations, Board of Optometric Examiners; 12-40-111, C.R.S. 1973)

124. Receives articles of incorporation from employers' mutual liability insurance companies, and licenses the applicant. (Division of Insurance, Commissioner's Office, Investigating and Licensing Section, Financial Examinations Section and Policy Analysis and Service Section; 10-12-203, C.R.S. 1973)
125. Collects reports semi-annually from professional bondsmen licensed in the state. (Division of Insurance, Investigating and Licensing Section; 12-7-105, C.R.S. 1973)
126. Requires the filing of financial reports from captive insurance companies and revokes or refuses to issue certificates for failure to file. (Division of Insurance, Commissioner of Insurance; 10-6-114, C.R.S. 1973)
127. Assures that insurance companies include in their annual financial statements all information required by statute. (Division of Insurance, Investigating and Licensing Section; 10-5-110 and 10-7-206, C.R.S. 1973)
128. Assures notice is given by a railroad whenever an accident attended by bodily injury or loss of human life occurs and assures every public utility furnishes a report as required by law. (Public Utilities Commission, Transportation Section; 40-9-108 and 40-3-110, C.R.S. 1973)
129. Assures real estate companies file annual reports which include the information required by statute. (Division of Real Estate, Real Estate Commission; 12-61-609, C.R.S. 1973)
130. Examines the books, records, papers, assets, and liabilities of banks in the state and reports the results of such examinations. (Division of Banking, Director's Office, Administrative, Examination, and Examination Review Sections as well as Public Deposits Protection Act Section, Commercial and Industrial Bank Unit, and Electronic Data Processing and Funds Transfer Unit; 11-20-112, C.R.S. 1973)
131. Examines and collects reports from state-chartered credit unions. (Division of Banking, Director's Office, Administrative Section, and Examination Section, Credit Union Unit; 11-30-106, C.R.S. 1973)
132. Collects reports on business transacted by surplus line brokers operating in the state. (Division of Insurance, Office of the Commissioner, Investigating and Licensing, Financial Examinations, Policy Analysis and Service Sections; 10-5-110, C.R.S. 1973)

133. Requires an annual audit of the records of life care institutions operating in the state by a certified public accountant. (Division of Insurance, Financial Examinations Section; 12-13-111, C.R.S. 1973)
134. Collects reports from cemetery authorities operating in the state and requires examination by a certified public accountant of the endowment care fund of cemetery authorities. (Division of Insurance, Financial Examinations Section; 12-12-110 and 111, C.R.S. 1973)
135. Collects annual reports from and examines the financial affairs of fraternal benefit societies operating in the state. (Division of Insurance, Office of the Commissioner, Investigating and Licensing, Financial Examinations, Policy Analysis and Service Sections; 10-14-124, 127, and 129, C.R.S. 1973)
136. Conducts audits of business accounts of pre-owned warranty service companies. (Division of Real Estate, Director's Office, Auditing Section; 12-61-106, C.R.S. 1973)

Companies

137. Issues rules and regulations for the supervision of the credit life and credit accident and health insurance business. (Division of Insurance, Office of the Commissioner and Financial Examinations Section; 10-10-114, C.R.S. 1973)
138. Promulgates rules regarding the operation of insurance rating and advisory organizations. (Division of Insurance, Office of the Commissioner, Investigating and Licensing, Policy Analysis and Service Sections; 10-4-404, C.R.S. 1973)
139. Establishes safety standards and other regulations for motor vehicle carriers. (Public Utilities Commission, Transportation Section; 40-2-116, C.R.S. 1973)
140. Prescribes rules and regulations covering the operations of contract carriers by motor vehicles. (Public Utilities Commission, Executive Secretary, Administrative, Transportation and Hearing Examiners Sections; 40-11-105, C.R.S. 1973)
141. Prescribes rules and regulations covering the operations of towing carriers. (Public Utilities Commission, Executive Secretary, Administrative and Transportation Sections; 40-13-107, C.R.S. 1973)
142. Promulgates and enforces rules regarding reserve requirements, loans and investments of state banks.

- (Division of Banking, Banking Board and Office of the Director, Special Examination Review Section; 11-7-101 through 111, C.R.S. 1973)
143. Promulgates and enforces rules regarding the purchase of property by state banks. (Division of Banking, Banking Board and Office of the Director, Special Examination Review and Examination Sections; 11-8-101 through 106, C.R.S. 1973)
 144. Promulgates and enforces rules regarding safe deposit boxes in the state banks. (Division of Banking, Director and Deputy Director, and Banking Board; 11-22-106, C.R.S. 1973)
 145. Promulgates and enforces rules regarding the fiduciary powers of state banks. (Division of Banking, Banking Board, Office of the Director and Deputy Director, Examination Section; 11-10-101 through 104, C.R.S. 1973)
 146. Promulgates and enforces rules regarding the operation of industrial banks in the state. (Division of Banking, Office of the Director and Deputy Director, Examination Section, Commercial and Industrial Bank Unit and Electronic Data Processing Unit; 11-22-102, C.R.S. 1973)
 147. Promulgates and enforces rules regarding the operation of trust companies in the state. (Division of Banking, Offices of the Director and Deputy Director; 11-23-103 through 114 and 11-24-101 through 106, C.R.S. 1973)
 148. Promulgates and enforces rules regarding the operation of credit unions in the state. (Division of Banking, Offices of the Director and Deputy Director, also the Administrative Section and Examination Section; 11-30-101 through 111, C.R.S. 1973)
 149. Promulgates and enforces rules regarding discriminatory practices in employment, housing, public accommodations and advertising in the state. (Division of Civil Rights, Commission, Director's Office, Administrative, Regional Offices, Compliance and Research and Education Sections; 24-34-306, 405, 406, 508, through 510, 24-34-602 through 605, 802, 705 through 707, C.R.S. 1973)
 150. Promulgates and enforces rules regarding the operation of insurance companies in the state. (Division of Insurance, Office of the Commissioner, Investigating and Licensing, Financial Examinations and Policy Analysis Sections; 10-3-101 through 112, C.R.S. 1973)
 151. Promulgates and enforces rules regarding the operation of self insured pools in the state. (Division of Insurance,

Office of the Commissioner and Financial Examinations
Section; 8-44-110, C.R.S. 1973)

152. Promulgates and enforces rules regarding the operation of captive insurance companies in the state. (Division of Insurance, Office of the Commissioner, Financial Examinations Section; 10-6-113 through 119 and 10-6-122 through 128, C.R.S. 1973))
153. Promulgates and enforces rules regarding interinsurance exchanges operating in the state. (Division of Insurance, Office of the Commissioner, Administrative, Financial Examinations, and Policy Analysis and Service Sections; 10-13-103, 106, and 108, C.R.S. 1973))
154. Reviews insurance rate filings and promulgates rules and statistical plans regarding property and casualty insurance rates and hears appeals on decisions made by those companies that establish their own rates. (Division of Insurance, Commissioner's Office, Administrative Section, Investigating and Licensing Section, Financial Examination Section and Policy Analysis and Service Section; 10-4-404, C.R.S. 1973))
155. Prescribes rules and regulations for the performance of services by each public utility in the state. (Public Utilities Commission, Secretary's Office, and also Fixed Utilities Section, Transportation Section, and Hearing Examiners Section; 40-4-101, et seq., C.R.S. 1973))
156. Prescribes rules and regulations and carries out the necessary supervisory functions to gain the compliance of public utilities with the law regarding energy reports, and forecasts, joint use of equipment and facilities, and certificates of public convenience and necessity. (Public Utilities Commission, Executive Secretary, Fixed Utilities Section, Hearing Examiners Section, and Administrative Section; 40-2-118, 40-4-104, and 40-5-102, C.R.S. 1973))
157. Promulgates rules and regulations for the safe transportation of hazardous materials. (Public Utilities Commission, Executive Secretary, and Transportation Section; 40-2.1-103, C.R.S. 1973))
158. Promulgates rules and regulations for the prevention of accidents in the operation of railroads in Colorado. (Public Utilities Commission, Executive Secretary, and Transportation and Administrative Sections; 40-9-108, C.R.S. 1973))
159. Promulgates rules and regulations covering the operations of contract carriers by motor vehicle. (Public Utilities Commission, Executive Secretary, and Administrative,

Transportation, and Hearing Examiners Sections; 40-11-105, C.R.S. 1973)

160. Prescribes standards of safety and safety devices for railroads. (Public Utilities Commission, Executive Secretary, and Administrative and Transportation Sections; 40-29-110, C.R.S. 1973))
161. Promulgates and enforces rules governing professional service corporations for the practice of chiropractic. (Division of Registrations, Board of Chiropractic Examiners; 12-33-124, C.R.S. 1973))
162. Promulgates and enforces rules governing engineering firms operating in the state. (Division of Registrations, Board of Registration for Professional Engineers and Professional Land Surveyors; 12-25-103 through 106, C.R.S. 1973))
163. Promulgates and enforces rules governing professional service corporations for the practice of optometry in the state. (Division of Registrations, Board of Optometric Examiners; 12-40-125, C.R.S. 1973))
164. Promulgates and enforces rules governing professional service corporations for the practice of psychology in the state. (Division of Registrations, Board of Psychologist Examiners; 12-43-118, C.R.S. 1973))
165. Promulgates and enforces rules governing funeral establishments licensed in the state. (Division of Registrations, Board of Mortuary Science; 12-54-107, C.R.S. 1973))
166. Promulgates and enforces rules governing plumbing firms licensed in the state. (Division of Registrations, Examining Board of Plumbers; 12-58-104, C.R.S. 1973))
167. Promulgates and enforces rules governing domestic and foreign savings and loan associations doing business in the state. (Division of Savings and Loan, Office of the Commissioner, Examination Section; 11-44-103 through 108, 110, 121, and 11-45-101 through 103, C.R.S. 1973))
168. Promulgates and enforces rules governing the issuance and sale of securities in the state. (Division of Securities, Enforcement and Examining and Licensing Sections; 11-51-112 through 119, C.R.S. 1973))
169. Promulgates and enforces rules regarding takeover bids on securities. (Division of Securities, Enforcement, Examining and Licensing Sections; 11-51.5-103, C.R.S. 1973))

170. Enforces rules and regulations regarding the operation of motor vehicle towing carriers. (Public Utilities Commission, Commissioners, Executive Secretary, Administrative and Transportation Sections; 40-13-110, C.R.S. 1973)
171. Promulgates and enforces rules for railroads. (Public Utilities Commission, Commission, Executive Secretary, Administrative, Transportation, and Hearing Examiners Sections; 40-29-110, C.R.S. 1973)
172. Makes and enforces rules and regulations for the control, supervision, fingerprinting and identification of persons licensed to operate races, race meets, racetracks and satellite facilities. (Division of Racing, Commission, Administrative Section; 12-60-105, C.R.S. 1973)
173. Requires life care institutions to establish an escrow account for entrance fees received prior to the date the resident is permitted to occupy his or her living unit in the facility. (Division of Insurance, Office of the Commissioner, Financial Examinations Section; 12-13-104, C.R.S. 1973)
174. Approves procedures for arbitration of the issue of liability for and reimbursement of benefits paid in cases involving disputes between motor vehicle insurers. (Division of Insurance, Office of the Commissioner, Investigating and Licensing, and Financial Examinations Sections; 10-4-717, C.R.S. 1973)
175. Supervises the business of insurance in Colorado to assure that it is conducted in accordance with state law and in a manner that protects policyholders and the general public. (Division of Insurance, Administrative, Investigating and Licensing Section, Policy Analysis and Service Section; 10-1-108, C.R.S. 1973)
176. Approves all forms for policies, certificates of insurance, notices of proposed insurance, applications for insurance, endorsements, and riders delivered or issued for delivery in this state, and the schedules of premium rates pertaining thereto. (Division of Insurance, Office of the Commissioner; 10-10-109, C.R.S. 1973)
177. Approves policy forms, endorsements, riders, or applications which become part of any policy for sickness and accident insurance. (Division of Insurance, Policy Analysis and Service Section as well as Commissioner's Office and Investigating and Licensing Section; 10-8-102. C.R.S. 1973)

178. Designates state and national banks to serve as depositories for public moneys. (Division of Banking, Banking Board, Director and Deputy Director; 11-10.5-118, C.R.S. 1973)
179. Receives cash or equivalent deposit from those providing preowned home warranty service contracts. (Division of Real Estate, Administrative Section; 12-61-604, C.R.S. 1973)
180. Directs the state treasurer to make payments out of the real estate recovery fund to qualified applicants. (Division of Real Estate, Administrative Section; 12-61-301 and 12-61-302, C.R.S. 1973)
181. Keeps a record of all fees and penalties collected from banks on a monthly basis and deposits collections. (Division of Banking, Office of the Director and Deputy Director, also the Administrative, Special Examination Review and Examination Sections, as well as Commercial and Industrial Bank Unit and Electronic Data Processing and Electronic Funds Transfers System Unit; 11-20-115, C.R.S. 1973)
182. Deposits licensing fees collected from public utilities operating in the state. (Public Utilities Commission, the Commission, Executive Secretary, Administrative, and Hearing Examiners Sections; 40-6-105, C.R.S. 1973)
183. Deposits licensing fees collected from motor vehicle contract carriers and motor vehicle towing carriers operating in the state. (Public Utilities Commission, the Commission, Executive Secretary, Administrative and Transportation Sections; 40-11-108 and 40-13-108, C.R.S. 1973)
184. Deposits all licensing fees collected from racing operations in the state. (Division of Racing, Executive Secretary; 12-60-110, C.R.S. 1973)
185. Receives taxes imposed on premiums for surplus life insurance. (Division of Insurance, Commissioner of Insurance; 10-5-112, C.R.S. 1973)
186. Deposits all registration fees collected from passenger tramway safety registrations. (Division of Registrations, Tramway Safety Board; 25-5-705, C.R.S. 1973)
187. Distributes assessments collected from state banks to the affected governmental units. (Division of Banking, Director and Deputy Director, Administrative and Public Deposits Protection Act Sections; 11-10.5-116, C.R.S. 1973)

188. Collects and deposits cash or securities representing the minimum capital required by law of insurance companies. (Division of Insurance, Office of the Commissioner; 10-3-201, C.R.S. 1973)
189. Collects premium taxes assessed to mutual insurance associations and companies. (Division of Insurance, Office of the Commissioner; 10-12-104, C.R.S. 1973)
190. Collects premium taxes assessed to surplus line brokers. (Division of Insurance, Office of the Commissioner; 10-5-111, C.R.S. 1973)
191. Administers the state's motor vehicle "no fault" insurance laws. (Division of Insurance, Commissioner's Office and Financial Examinations Section; 10-4-704, C.R.S. 1973)
192. Administers the state's employee group insurance and approves other sickness and accident insurance plans. (State Employees and Officials Group Insurance Board, Commissioner's Office, and Administrative as well as Financial Examinations and Policy Analysis Sections; 10-8-205, C.R.S. 1973)
193. Receives a schedule of insurance premiums and related data from every title insurance company operating in the state. (Division of Insurance, Office of the Commissioner, Investigation and License Section and also Financial Examinations Section and Policy Analysis and Service Section; 10-11-118, C.R.S. 1973)
194. Provides general supervision regarding enforcement of the law relating to life care agreements. (Division of Insurance, Financial Examinations Section; 12-13-105 through 107, 110, and 12-13-116, C.R.S. 1973)
195. Examines the financial condition, affairs, and management of any insurance company or society operating under the insurance laws of this state. (Division of Insurance, Office of the Commissioner, Administrative, Investigating and Licensing Sections; 10-1-110, C.R.S. 1973)
196. Oversees and regulates foreign and domestic insurance companies operating in the state. (Division of Insurance, Office of the Commissioner, Investigating and Licensing, Financial Examinations, Policy Analysis and Service Sections; 10-1-111, 117, and 10-2-101 through 216, C.R.S. 1973)
197. Approves changes in no-fault auto insurance policies. (Division of Insurance, Office of the Commissioner, Administrative, Investigating and Licensing, Financial Examinations and Policy Analysis Services Sections; 10-4-720, C.R.S. 1973)

198. Examines the financial condition, affairs and management of nonprofit hospitals operating in the state. (Division of Insurance, Office of the Commissioner, Investigating and Licensing, Financial Examinations Sections; 10-16-120, C.R.S. 1973)
199. Promulgates and enforces rules governing the sale and manufacture of prescription and non-prescription drugs in the state. (Division of Registrations, Board of Pharmacy; 12-22-120, C.R.S. 1973)
200. Cooperates with public and private organizations in the planning and conducting of educational programs to eliminate racial, religious, cultural, and intergroup tensions. (Civil Rights Commission, as well as Director's Office, Administrative, all Regional Offices, Compliance, Research and Education Sections; 24-35-305, C.R.S. 1973)
201. Provides information on the federal, state, and local requirements necessary to begin a business. (Office of Regulatory Reform; 24-34-904, C.R.S. 1973)
202. Notifies affected small businesses of proposed rules of executive agencies. (Office of Regulatory Reform; 24-4-103.5 (2), C.R.S. 1973)
203. Performs any acts necessary to expedite the permit process as it impacts the establishment and operation of a small business. (Office of Regulatory Reform; 24-34-908, C.R.S. 1973)
204. Provides information, training, technical assistance, and advice and counsel to state agencies, businesses and individuals interested in energy conservation. (Office of Energy Conservation, Office of Public Affairs, and all Units; Federal Regulations)
205. Advises the Racing Commission regarding the promotion and improvement of horse racing in the state. (Division of Racing, Executive Secretary and Advisory Commission; 12-60-119 (3), C.R.S. 1973)
206. Makes recommendations to the General Assembly regarding improvements in the permitting process as that process affects the small business community. (Office of Regulatory Reform; 24-34-904 (1) (j), C.R.S. 1973)
207. Collects and deposits application fees for bank charters and when applicable, refunds a portion of such fees. (Division of Banking, Office of the Director and Deputy Director; 11-3-107, C.R.S. 1973)

208. Regulates captive insurance companies operating in the state. (Division of Insurance, Office of the Commissioner, Financial Examinations Section; 10-6-113, C.R.S. 1973)
209. Regulates foreign or domestic life insurance companies operating in the state. (Division of Insurance, Office of the Commissioner, Investigating and Licensing Section; 12-7-105, C.R.S. 1973)
210. Regulates mutual liability insurance companies. (Division of Insurance, Office of the Commissioner, Investigating and Licensing, Policy Analysis and Service Sections; 10-12-103, 203, and 208 through 305, C.R.S. 1973)
211. Regulates the property and casualty insurance industry in the state. (Division of Insurance, Office of the Commissioner, Investigating and Licensing, Policy Analysis and Service Sections; 10-4-406 and 407, 413, 510, and 704, C.R.S. 1973)
212. Regulates the sickness and accident insurance industry in the state including approval of policy forms. (Division of Insurance, Office of the Commissioner, Investigating and Licensing, Policy Analysis and Service Sections; 10-8-102, C.R.S. 1973)
213. Regulates the surplus line insurance industry in the state. (Division of Insurance, Office of the Commissioner, Investigating and Licensing, Financial Examinations, Policy Analysis and Service Sections; 10-5-108, C.R.S. 1973)
214. Regulates title insurance operations in the state. (Division of Insurance, Office of the Commissioner, Investigating and Licensing Section; 10-11-118 and 119, C.R.S. 1973)
215. Regulates endowment care funds and preneed funeral contracts. (Division of Insurance, Office of the Commissioner, Financial Examinations Section; 12-12-111, C.R.S. 1973)
216. Regulates public utilities including the setting and enforcement of public utility rates, charges, and regulations, and a uniform system of accounts. (Public Utilities Commission, Administrative, Transportation, Fixed Utilities and Hearing Examiners Sections and Executive Secretary; 40-7-102, 103, 107, and 111, 40-5-102, and 40-7-101, C.R.S. 1973)

Mergers and Liquidations

217. Approves bank mergers in the state. (Division of Banking, Banking Board, Office of the Director and Deputy Director; 11-4-104, C.R.S. 1973)
218. Approves and supervises bank liquidations in the state. (Division of Banking, Banking Board, Office of Director and Deputy Director, Administrative Section; 11-5-101 and 102, C.R.S. 1973)
219. Provides for the orderly disposition of unclaimed property currently held as a result of a bank liquidation prior to July 1, 1957, which property consists of the contents of safety deposit boxes. (Division of Banking, Director; 11-6-111, C.R.S. 1973)
220. For the purpose of liquidating a bank, collects all debts, dues and claims belonging to the bank and upon court order, sells or compounds all bad debts and sells all real estate and personal property of the bank. (Division of Banking, Banking Board, Office of the Director, and Examinations Section, Commercial and Industrial Bank Unit and Electronic Data Processing Funds Transfer Unit; 11-21-104, C.R.S. 1973)
221. Liquidates credit unions based on acts of willful violation or operation in an unsafe or unsound manner. Issues orders to show cause why operations should not be suspended until prescribed manner of operation is rectified. Approves mergers of credit unions. (Division of Banking, Director and Deputy Director, Administrative and Examination Sections, and Credit Union Unit; 11-30-120, C.R.S. 1973)
222. Upon the dissolution of an insurance company, liquidates all its assets. (Division of Insurance, Office of the Commissioner, Investigating and Licensing, Financial Examinations, Policy Analysis and Service Sections; 10-12-217, C.R.S. 1973)
223. Liquidates savings and loan associations based on acts of willful violation or operation in an unsafe or unsound manner. Issues orders to show cause why operations should not be suspended until the prescribed manner of operation is rectified. (Division of Savings and Loan, Office of the Commissioner; 11-44-116, C.R.S. 1973)
224. Takes possession of the property of a life care provider which is insolvent, or in a financially unsound or unsafe condition and conducts the business thereof. (Division of Insurance, Office of the Commissioner, Financial Examinations Section; 12-13-105 and 109, C.R.S. 1973)

225. Files with county clerks evidence of the appointment of the Federal Deposit Insurance Corporation to serve as liquidator for any state banking institution insured by it. (Division of Banking, Banking Board, Director and Deputy Director, as well as Administrative and Examination Sections, and Commercial and Industrial Bank and Electronic Data Units; 11-5-105, C.R.S. 1973)
226. Borrows from the FDIC and furnishes assets of a liquidated banking institution to the FDIC as security for a loan. (Division of Banking, Banking Board, Office of the Director, Administrative Section; 11-5-106, C.R.S. 1973)
227. Delivers to the state treasurer all unclaimed property of a bank or other corporation held as the result of a liquidation. (Division of Banking, Office of the Director, Administrative Section; 11-6-110, 11-6-111, C.R.S. 1973)

Individuals

228. Promulgates and enforces rules regarding the conduct of persons licensed as real estate brokers or salesmen in the state. (Division of Real Estate, Commissioners, Administrative, Auditing, Education and Licensing, and Investigations Sections; 12-61-109, C.R.S. 1973)
229. Promulgates and enforces rules regarding the operations of persons licensed as real estate developers in the state. (Division of Real Estate, Commissioners, Education and Licensing, and Investigations Sections; 12-61-407 and 114, C.R.S. 1973)
230. Promulgates and enforces rules regarding the operations of persons licensed as certified public accountants in Colorado. (Division of Registrations, Board of Accountancy; 12-2-119 through 122 and 12-2-131, C.R.S. 1973)
231. Deposits all registration fees collected from abstractors licensed in the state. (Division of Registrations, Board of Abstractors; 12-1-111, C.R.S. 1973)
232. Promulgates and enforces rules regarding the practice of architecture in the state. (Division of Registrations, Board of Architects; 12-4-107, 113, 119, and 120, C.R.S. 1973)
233. Promulgates and enforces rules governing barbers and cosmetologists licensed in the state. (Division of Registrations, Board of Barbers and Cosmetology; 12-8-108, and 12-8-123 through 126, C.R.S. 1973)

234. Promulgates and enforces rules regarding the practice of dentistry and dental hygiene in the state. (Division of Registrations, Board of Dental Examiners; 12-35-107, 108 and 125, C.R.S. 1973)
235. Provides inspections of electrical installations where local inspection authorities are not providing such service. (Division of Registrations, State Electrical Board; 12-23-100.2, C.R.S. 1973)
236. Collects and deposits license and examination fees for insurers, insurance agents, brokers, surplus line brokers, and insurance adjusters operating in the state. (Division of Insurance, Administrative, Investigating and Licensing, Financial Examinations Sections; 10-2-101 through 216, C.R.S. 1973)
237. Deposits all licensing fees collected from real estate brokers and salesmen operating in the state. (Division of Real Estate, Administrative, Education and Licensing Sections; 12-61-111, C.R.S. 1973)
238. Deposits all fees collected from public accountants certified in the state. (Division of Registrations, Board of Accountancy; 12-2-106 and 107, C.R.S. 1973)
239. Deposits all registration fees collected from chiropractors licensed in the state. (Division of Registrations, Board of Chiropractic Examiners; 12-33-109, C.R.S. 1973)
240. Deposits all registration fees collected from dentists licensed in the state. (Division of Registrations, Board of Dental Examiners; 12-35-121, C.R.S. 1973)
241. Deposits all registration fees collected from dental hygienists licensed in the state. (Division of Registrations, Board of Dental Examiners; 12-35-127, C.R.S. 1973)
242. Deposits all registration fees collected from nursing home administrators licensed in the state. (Division of Registrations, Board of Examiners of Nursing Home Administrators; 12-39-116, C.R.S. 1973)
243. Deposits all registration fees collected from electricians licensed in the state. (Division of Registrations, State Electrical Board; 12-23-113, C.R.S. 1973)
244. Deposits all registration fees collected from hearing aid dealers licensed to do business in the state. (Division of Registrations, Board of Hearing Aid Dealers; 12-65-121, C.R.S. 1973)

245. Deposits all registration fees collected from those licensed under provisions of the state medical practices act. (Division of Registrations, Board of Medical Examiners; 12-36-130, C.R.S. 1973)
246. Deposits all registration fees collected from registered nurses in the state. (Division of Registrations, Board of Nursing; 12-38-215, C.R.S. 1973)
247. Deposits all registration fees collected from practical nurses licensed in the state. (Division of Registrations, Board of Nursing; 12-38-215, C.R.S. 1973)
248. Deposits all registration fees collected from optometrists licensed in the state. (Division of Registrations, Board of Optometric Examiners; 12-40-111, C.R.S. 1973)
249. Deposits all registration fees collected from psychiatric technicians licensed in the state. (Division of Registrations, Board of Nursing; 12-42-110, C.R.S. 1973)
250. Deposits all registration fees from psychologists licensed in the state. (Division of Registrations, Board of Psychologist Examiners; 12-43-105, C.R.S. 1973)
251. Deposits all registration fees from mobile home dealers licensed in the state. (Division of Registrations, Board of Mobile Home Dealers; 12-51.5-110, C.R.S. 1973)
252. Deposits all registration fees collected from persons licensed to practice mortuary science in the state. (Division of Registrations, Board of Mortuary Science; 12-54-115, C.R.S. 1973)
253. Deposits all registration fees collected from veterinarians licensed in the state. (Division of Registrations, Board of Veterinary Medicine; 12-64-105, C.R.S. 1973)
254. Collects licensure fees from architects and transmits the same to the state treasury. (Division of Registrations, Board of Architects; 12-4-105, C.R.S. 1973)
255. Collects and deposits all fees assessed to barbers and cosmetologists licensed in the state. (Division of Registrations, Board of Barbers and Cosmetology; 12-8-116, C.R.S. 1973)
256. Collects and deposits all fees assessed to engineers and land surveyors licensed in the state. (Division of Registrations, Board of Registration for Professional Engineers and Professional Land Surveyors; 12-25-119, 120 and 206, C.R.S. 1973)

- 257. Collects down payments or earnest moneys to be deposited in an escrow or trust account of any mobile home dealer serving as an agent for another dealer. (Division of Registrations, Board of Mobile Home Dealers; 12-51.5-125, C.R.S. 1973)
- 258. Collects and deposits all fees assessed to plumbers licensed in the state. (Division of Registrations, Board of Plumbers; 12-58-114, C.R.S. 1973)
- 259. Collects and deposits all fees assessed to social workers licensed in the state. (Division of Registrations, Board of Social Workers; 12-63.5-113, C.R.S. 1973)

Provides Coordinated Internal Support and Management

- 260. Serves as chief executive officer of the Department of Regulatory Agencies. (Office of the Executive Director; 24-35-101, C.R.S. 1973)
- 261. Establishes, combines, or abolishes divisions, sections, and units other than those specifically created by law. (Division of Administrative Services, Director's Office, Administrative Section; 24-1-107, C.R.S. 1973; also Division of Banking, Administrative Section; no state statutory mandate; also Division of Civil Rights, Administrative Section; No state statutory mandate; also Division of Racing, Administrative Section; no state statutory mandate; also Division of Real Estate, Office of the Director, Administrative Section; no state statutory mandate; also Division of Securities, Administrative Section; no state statutory mandate; also Office of Energy Conservation, Administrative Unit; no state statutory mandate; and Division of Registrations, Investigative Section, Program Administrators; no state statutory mandate.)
- 262. Supervises examining and licensing boards within the Division of Registrations. (Office of the Executive Director and Director, Division of Registrations; 24-34-102, C.R.S. 1973)
- 263. Approves such rules and regulations of occupational boards and agencies as they relate to the examination of applicants for state licensure. (Executive Director's Office and Division of Administrative Services; 24-34-102 (3), C.R.S. 1973)
- 264. Coordinates the administration of services (investigations, examinations and hearings) for those required to be certified or licensed to conduct their occupations or professions. (Executive Director's Office; 24-34-102, C.R.S. 1973)

- 265. Receives and monitors the disposition of complaints and may cause an investigation to be made of any complaint presented concerning a person licensed by any board or agency in the division of registrations. (Office of the Executive Director; 24-34-102 (9), C.R.S. 1973)
- 266. Develops, maintains and manages departmental fiscal and budget activities, ADP, records management program, personnel actions, and plans policies and procedures pertaining to all aspects of the department's administrative matters. (Division of Administrative Services, Director, Accounting, ADP, Budget, and Personnel; 24-34-102, C.R.S. 1973)
- 267. Administers and prescribes rules for the distribution of the real estate recovery fund. (Division of Real Estate, Commissioners, and Office of the Director, Investigations Section; 12-61-301 and 302, C.R.S. 1973)
- 268. Supervises and aids in the enforcement of rules promulgated by examining and licensing boards and agencies within the department of regulatory agencies. (Office of Executive Director, Division of Administrative Services, Accounting Section; 24-34-102, C.R.S. 1973)

Provides Corrective Actions Against Credentialed Companies and Individuals

Companies

Fees and Fines

- 269. Receives fines for violations of the laws concerning franchise and credit life insurance. (Division of Insurance, Commissioner of Insurance; 10-10-116, C.R.S. 1973)
- 270. Collects fines imposed for violations of the laws concerning racing. (Division of Racing, Racing Commission, Administrative Section; 12-60-110, C.R.S. 1973)
- 271. Insures fines imposed for violations of the laws concerning public utilities including motor vehicle carriers and contract motor carriers are paid. (Public Utilities Commission, Transportation, Hearing Examiners and Administration Sections; 40-10-108 and 113, and 40-11-107, C.R.S. 1973)
- 272. Enforces the statutory provisions for penalties for violations of the laws concerning towing carriers. (Public Utilities Commission, Transportation and Administrative Sections; 40-13-110, C.R.S. 1973)

273. Imposes fines for violations of the laws and regulations concerning mobile home dealers. (Division of Registrations, Mobile Home Licensing Board; 12-51.5-121, C.R.S. 1973)
274. Imposes fines against life care institutions operating without certification or in violation of state laws. (Division of Insurance, Office of the Commissioner and Financial Examinations Section; 12-13-112, C.R.S. 1973)
275. Imposes fines against officers, directors, clerks, employees, and agents of captive insurance companies who receive, pay out, or order the payment of any money, or incur any obligation for the payment of money in violation of state law. (Division of Insurance, Office of the Commissioner; 10-6-110, C.R.S. 1973)
276. Imposes fines against mutual insurance associations which violate state regulations. (Division of Insurance, Office of the Commissioner, Administrative, Investigating and Licensing, Financial Examinations and Policy Analysis Sections; 10-12-103 and 10-12-331, C.R.S. 1973)
277. Enforces and collects all fines and levies to be paid by the racing industry. (Division of Racing, Commission; 12-60-110, C.R.S. 1973)
278. Imposes fines against savings and loan associations violating state regulations. (Division of Savings and Loan, Office of the Commissioner; 11-40-105, C.R.S. 1973)
279. Records all fees and penalties collected from banks in the state and monthly turns over all moneys collected to the state treasurer. (Division of Banking, Director, Administrative and Examination Sections, Electronic Data Processing Transfers System Unit; 11-20-115, C.R.S. 1973)

Judicial Proceedings

280. Denies, revokes or suspends registrations, issues orders for corrective action, applies for injunction or prosecution; conducts investigations and inspections, and orders emergency shut down in connection with violations of the laws concerning ski tows, ski lifts, and passenger tramways. (Division of Registrations, Passenger Tramway Safety Board and Investigations Section; 25-5-710 (1) (c) and (d), 711 through 714, and 716, C.R.S. 1973)
281. Seeks injunctions to enforce the provisions of the law concerning corporation take-over bids and take-over bid disclosure. (Division of Securities, Enforcement Section; 11-51.5-108, C.R.S. 1973)

282. Acts as agent for the service of process to a licensed motor club. (Division of Insurance, Investigating and Licensing Section; 12-53-107, C.R.S. 1973)
283. Exchanges information with other governmental entities regarding public utilities and notifies the state's attorney general or local district attorneys of suspected violations of laws or orders and the like regarding public utilities. (Public Utilities Commission, Executive Secretary, Transportation and Hearing Examiners Sections; 40-2-115 and 40-10-115, C.R.S. 1973)
284. Imposes corrective action against any officer, director, employee or agent of an industrial bank who violates state regulations. (Division of Banking, Offices of the Director and Deputy Director, Administrative and Examination Section, Commercial and Industrial Bank Unit, and Electronic Data Processing and Funds Transfers System Unit; 11-22-114, C.R.S. 1973)
285. Serves as the agent for service of process for any surplus line insurance dealer in the state sued for violation of contract. (Division of Insurance, Office of the Commissioner, Administrative, Investigating and Licensing, and Financial Examinations Sections; 10-5-114, C.R.S. 1973)
286. Brings legal action against any public utility violating state regulations. (Public Utilities Commission, Commissioners, Secretary, Transportation, Fixed Utilities, and Hearing Examiners Sections; 40-7-104, C.R.S. 1973)
287. Files suits for injunctions against state banking institutions violating state banking regulations. (Division of Banking, Banking Board, Director and Deputy Director, and Administrative Section; 11-11-109, C.R.S. 1973)
288. Invokes the aid of the courts through injunction or other proper process, mandatory or otherwise, to enforce any order or regulation dealing with the insurance industry in the state. (Division of Insurance, Office of the Commissioner; 10-1-112, C.R.S. 1973)
289. Serves as the agent for service of process for subscribers exchanging interinsurance contracts in this state. (Division of Insurance, Office of the Commissioner, Investigating and Licensing, Financial Examinations Sections; 10-13-104, C.R.S. 1973)
290. Delegates jurisdiction over motor vehicle contract carriers to district and county courts where such vehicles operate. (Public Utilities Commission, the Commission, Executive Secretary, Administrative, Transportation, and Hearing Examiners Sections; 40-11-112, C.R.S. 1973)

291. Requests the state attorney general or the district attorney of any judicial district in the state to bring legal action against any motor vehicle towing carrier under their jurisdiction who violates state regulations. (Public Utilities Commission, the Commission; 40-13-112, C.R.S. 1973)
292. Serves as defendant in appeals of commission decisions regarding railroads and their employees. (Public Utilities Commission, the Commission; 40-32-111, C.R.S. 1973)
293. Applies to courts of competent jurisdiction for orders enjoining any act which constitutes a violation of state regulations regarding subdivision contractors or pre-owned warranty service companies. (Division of Real Estate, Office of the Director, and Auditing, Education and Licensing, and Investigations Sections; 12-61-406, C.R.S. 1973)
294. Applies to the district court of the city and county of Denver to temporarily or permanently restrain or enjoin any person from committing an act in violation of state regulations regarding securities. (Division of Securities, Enforcement, Examination and Licensing Sections; 11-51-122, C.R.S. 1973)

Orders

295. Conducts inspections, holds hearings, and issues orders to enforce compliance with regulations and laws governing the use of safety equipment on railroads. (Public Utilities Commission, Transportation Section; 40-29-110 through 112, C.R.S. 1973)
296. Conducts inspections, holds hearings, issues orders and imposes penalties to insure compliance with prescribed standards of safety, sanitation, and health for railroads. (Public Utilities Commission, Transportation Section; 40-32-109 through 111, C.R.S. 1973)
297. Issues orders for corrective action in connection with violations of the laws concerning passenger tramways. (Division of Registrations, Passenger Tramway Safety Board; 25-5-713, C.R.S. 1973)
298. Imposes corrective actions against motor clubs violating state regulations. (Division of Insurance, Commissioner's Office; 12-53-109, C.R.S. 1973)
299. Imposes corrective actions against motor vehicle carriers violating state regulations. (Public Utilities Commission, Commissioners, Secretary, Transportation, and Hearing Examiners Sections; 40-10-108 and 113, C.R.S. 1973)

300. Imposes corrective actions against contract motor carriers violating state regulations. (Public Utilities Commission, Commissioners, Secretary, Administrative, Transportation, and Hearing Examiners Sections; 40-11-111 through 113, C.R.S. 1973)

Revocations and Suspensions

301. Conducts hearings and when necessary may refuse, revoke or suspend the registration of any pre-owned warranty service company. (Division of Real Estate, Investigations Section; 12-61-606, C.R.S. 1973)
302. Holds hearings, denies, suspends or revokes licenses; and conducts investigations in order to enforce the laws governing racing. (Division of Racing, Racing Commission and Administration, Greyhound Racing and Horse Racing Sections; 12-60-105.5, 106.5, and 113, C.R.S. 1973)
303. Conducts investigations and holds hearings; censures licensees; and suspends, revokes or refuses to renew licenses in order to enforce the laws governing real estate. (Division of Real Estate, Real Estate Commission, Auditing and Investigations Sections; 12-61-109 and 113, C.R.S. 1973)
304. Reviews and may deny, suspend, revoke or refuse to renew registrations for preowned home warranty service contracts. (Division of Real Estate, Investigations and Auditing Sections; 12-61-605 through 606, C.R.S. 1973)
305. Suspends, denies, or revokes certificates and licenses of adjusters, agents and brokers for violations of the laws governing insurance. (Division of Insurance, Commissioner of Insurance and Investigating and Licensing Section and Policy Analysis and Service Section; 10-1-111, 10-2-115, 10-2-210, and 10-2-212, C.R.S. 1973)
306. Revokes, suspends or refuses certificates of authority for violations of the laws governing interinsurance. (Division of Insurance, Commissioner of Insurance; 10-13-111 and 113, C.R.S. 1973)
307. Revokes, suspends, or refuses certificates of authority for violations of the laws governing title insurance. (Division of Insurance, Commissioner of Insurance; 10-7-105, C.R.S. 1973)
308. Revokes licenses for violations of the laws concerning sickness and accident insurance. (Division of Insurance, Commissioner of Insurance; 10-8-118, C.R.S. 1973)

309. Suspends or revokes licenses for violations of the laws concerning cemetery authorities and preneed funerals. (Division of Insurance, Commissioner of Insurance; 12-12-108, C.R.S. 1973)
310. Suspends, revokes, alters or amends certificates or registrations for violations of orders, rules or regulations of the commission concerning motor vehicle carriers. (Public Utilities Commission, Transportation, Hearing Examiners and Administrative Sections; 40-10-112, C.R.S. 1973)
311. Revokes, suspends, alters or amends permits or registrations for violations of the laws or regulations concerning contract motor carriers. (Public Utilities Commission, Transportation, Hearing Examiners, Administrative and Fixed Utilities Sections; 40-11-110, C.R.S. 1973)
312. Revokes, suspends or refuses registration of developers for violations of the laws concerning the development of subdivisions. (Division of Real Estate, Real Estate Commission; 12-61-405, C.R.S. 1973)
313. Denies, revokes, or suspends registrations for violations of orders of the board and the laws concerning passenger tramways. (Division of Registrations, Passenger Tramway Safety Board; 25-5-710 (1) (c) and 716, C.R.S. 1973)
314. Denies, revokes, suspends, and refuses licenses for violations of the laws concerning mobile home dealers. (Division of Regulations, Mobile Home Licensing Board; 12-51.5-103 (3) (g), (3) (1), and (6) (d), 12-51.5-119 and 12-51.5-121 (2), C.R.S. 1973)
315. Denies, suspends and revokes licenses for violations of the laws concerning securities. (Division of Securities, Enforcement Section; 11-51-111 through 11-51-113, C.R.S. 1973)
316. Suspends the certification of credit unions operating in an unsound manner and, when necessary, may liquidate the assets of said credit union. (Division of Banking, Director and Deputy Director, as well as Administrative Section, Examination Section, Credit Union Unit; 11-30-120, C.R.S. 1973)
317. Oversees and regulates self-insurance pools and when necessary, suspends or revokes their certificate of public authority. (Division of Insurance, Financial Examinations Section; 8-44-110, C.R.S. 1973)

318. Levies fines and suspends or revokes certification for any credit life and credit accident and health insurance firm violating state law. (Division of Insurance, Financial Examinations Section; 10-10-116, C.R.S. 1973)
319. Regulates and when necessary suspends or revokes certificates of authority for corporations exchanging interinsurance contracts. (Division of Insurance, Office of the Commissioner, Investigating and Licensing, Financial Examinations, Policy Analysis and Service Sections; 10-13-111 and 113, C.R.S. 1973)
320. Suspends the certification of authority of any foreign or domestic life insurance company violating state regulations. (Division of Insurance, Office of the Commissioner, Administrative Section, as well as Investigating and Licensing, Financial Examinations and Policy Analysis Sections; 10-7-105, C.R.S. 1973)
321. Regulates and when necessary suspends or revokes certification for any mutual insurance company violating state regulations. (Division of Insurance, Office of the Commissioner, Administrative Section, as well as Investigating and Licensing, Financial Examinations, and Policy Analysis Sections; 10-12-322, 328, 308, and 111, C.R.S. 1973)
322. Levies fines and when necessary suspends or revokes the license of any rating organization or property and casualty insurer who violates state regulations. (Division of Insurance, Office of the Commissioner, Investigating and Licensing, Financial Examinations, Policy Analysis and Service Sections; 10-4-317, C.R.S. 1973)
323. Regulates and when necessary may revoke or suspend the license of a corporation delivering or issuing for delivery sickness and accident insurance in violation of state regulations. (Division of Insurance, Office of the Commissioner, Investigating and Licensing, Financial Examinations, Policy Analysis and Service Sections; 10-8-118, C.R.S. 1973)
324. Regulates and when necessary suspends or revokes the license of any cemetery authority violating state regulations. (Division of Insurance, Office of the Commissioner, Investigating and Licensing, Financial Examinations Sections; 12-12-108, C.R.S. 1973)
325. Regulates and when necessary revokes or suspends the certification of non-profit hospitals violating state regulations and when such hospital is insolvent, initiates liquidation proceedings. (Division of Insurance, Administrative, Investigating and Licensing, Financial

Examinations, and Policy Analysis Sections; 10-16-121, C.R.S. 1973)

326. Regulates and when necessary revokes or suspends the certificate of public convenience and necessity of corporations operating motor vehicle carriers. (Public Utilities Commission, Secretary's Office, Administrative, Transportation, and Hearing Examiners Sections; 40-10-112, C.R.S. 1973))
327. Regulates and when necessary revokes or suspends the permit of any corporation licensed to operate motor vehicle towing carriers. (Public Utilities Commission, Commissioners, Executive Secretary, Administrative and Transportation Sections; 40-13-109, C.R.S. 1973))
328. Regulates and when necessary revokes or suspends the registration of any development company violating state regulations. (Division of Real Estate, Commissioners, Investigations Section; 12-61-405, C.R.S. 1973))
329. Regulates and when necessary revokes or suspends the registration of any public accounting firm or corporation violating state regulations. (Division of Registrations, Board of Accountancy; 12-2-124, C.R.S. 1973))
330. Regulates and when necessary revokes or suspends the registration of any architectural firm violating state regulations. (Division of Registrations, Board of Architects; 12-4-115, C.R.S. 1973))
331. Regulates and when necessary revokes the license of and aids in the prosecution of, barber schools, shops, beauty salons or schools violating state regulations. (Division of Registrations, Board of Barbers and Cosmetology; 12-8-127, 128, and 132, C.R.S. 1973))
332. Regulates and when necessary revokes or suspends the license of any electrical firm violating state regulations. (Division of Registrations, State Electrical Board; 12-23-118, C.R.S. 1973))
333. Regulates and when necessary revokes or suspends the registration of any mortuary or funeral home violating state regulations. (Division of Registrations, Board of Mortuary Science; 12-54-116, C.R.S. 1973))
334. Regulates and when necessary revokes or suspends the registration of any securities issuer violating state regulations. (Division of Securities, Examining and Licensing Section as well as Enforcement Section; 11-51-112, C.R.S. 1973))

Individuals

Fees and Fines

335. Collects damages, if a court finds that the respondent committed an unfair housing practice, discriminated in places of public accommodation, or practiced discriminatory advertising. (Division of Civil Rights, Civil Rights Commission; 24-34-510, 602, 605, 705, and 707, C.R.S. 1973)
336. Collects, as a complainant, such penalties as ordered by a court for the violation of the civil rights of blind and other handicapped persons. (Division of Civil Rights, Civil Rights Commission; 24-34-802, C.R.S. 1973)
337. Insures fines imposed for violations of the laws concerning securities are paid. (Division of Securities, Enforcement Section; no statutory citation)
338. Imposes fines on persons, firms, or corporations selling franchise insurance in violation of state regulations. (Division of Insurance, Office of the Commissioner; 10-10-116, C.R.S. 1973)
339. Imposes fines against any attorney, agent or representative who unlawfully enters into an interinsurance contract. (Division of Insurance, Office of the Commissioner, and Investigating and Licensing Section; 10-13-110, C.R.S. 1973)
340. Imposes fines against persons or organizations who violate state regulations regarding property and casualty insurance. (Division of Insurance, Office of the Commissioner and Investigating and Licensing Section; 10-4-317, C.R.S. 1973)
341. Imposes fines against surplus line insurance brokers who fail to comply with state regulations. (Division of Insurance, Office of the Commissioner; 10-5-112, C.R.S. 1973)
342. Imposes fines against architects violating state regulations. (Division of Registrations, Board of Architects; 12-4-118, C.R.S. 1973)
343. Imposes fines against persons practicing mortuary science who violate state regulations. (Division of Registrations, Board of Mortuary Science; 12-54-118, C.R.S. 1973)
344. Levies fines against surplus line brokers failing to comply with state regulations. (Division of Insurance, Office of the Commissioner, Investigating and Licensing, Financial Examinations Sections; 10-5-112, C.R.S. 1973)

345. Receives taxes imposed on bail bondsmen as a part of the division's regulatory authority. (Division of Insurance, Investigating and Licensing Section; 12-7-111, C.R.S. 1973)

Judicial Proceedings

346. Takes legal action against any contract carrier who is failing or omitting to do anything required of it by law or regulation. (Public Utilities Commission, Executive Secretary; 40-11-113, C.R.S. 1973)
347. Conducts investigations and causes the enjoinder or prosecution of persons concerning violations of the laws governing barbers and cosmetologists. (Division of Registrations, State Board of Barbers and Cosmetologists; 12-8-108 (f) through (i), C.R.S. 1973)
348. Conducts investigations, holds hearings and applies for corrective relief in connection with violations of laws governing medical practice. (Division of Registrations, State Board of Medical Examiners; 12-36-104 (1) (b), 12-36-118 and 12-36-132, C.R.S. 1973)
349. Denies, suspends, or revokes licenses or registrations; applies for restraining orders and injunctions; and otherwise enforces the laws concerning pharmacists. (Division of Registrations, State Board of Pharmacy; 12-22-110 (1) (c), (1) (d), and (2); 12-22-125, C.R.S. 1973)
350. Denies, suspends, or revokes licenses; conducts investigations, holds hearings, applies for injunction; and otherwise disciplines licensees in connection with violations of the laws governing veterinarians. (Division of Registrations, State Board of Veterinary Medicine; 12-64-105 (9) (b), (e), and (f); 12-64-111 and 114 (3), C.R.S. 1973)
351. Brings legal action against electricians violating state regulations. (Division of Registrations, State Electrical Board; 12-23-119, C.R.S. 1973)
352. Brings legal action against any broker-dealer or issuer-dealer violating state regulations. (Division of Securities, Enforcement, Examining and Licensing Sections; 11-51-124, C.R.S. 1973)
353. Petitions district courts for the issuance of subpoenas in cases dealing with discrimination. (Division of Civil Rights, Commission, Director, Administrative, Compliance, and Regional Units; 24-34-305 (1) (d), C.R.S. 1973)

354. Furnishes courts with the names of all state-licensed bondsmen and notifies such courts of any suspension, revocation or reinstatement of a bondsman's license or of the insolvency of any surety company. (Division of Insurance, Office of the Commissioner, Investigating and Licensing Section; 12-7-107, C.R.S. 1973)
355. Takes legal action against real estate brokers and salesmen found violating state regulations. (Division of Real Estate, Office of the Director, Education and Licensing, Investigations Sections; 12-61-119, C.R.S. 1973)
356. Applies for an injunction in any court of competent jurisdiction to enjoin actions by persons practicing architecture in violation of state regulations. (Division of Registrations, Investigations Section, Board of Architects; 12-4-113, C.R.S. 1973)
357. Aids the state attorney general and the several district attorneys in the prosecution of barbers and cosmetologists found to be violating state regulations. (Division of Registrations, Investigations Section, Board of Barbers and Cosmetology; 12-8-128, C.R.S. 1973)
358. Aids the state attorney general and the several district attorneys in the prosecution of chiropractors found to be violating state regulations. (Division of Registrations, Investigations Section, Board of Chiropractic Examiners; 12-33-122, C.R.S. 1973)
359. Applies with the attorney general for injunctions to enjoin persons from committing acts in violation of state regulations regarding nursing home administrators. (Division of Registrations, Investigations Section, Board of Nursing Home Administrators; 12-39-114, C.R.S. 1973)
360. Initiates disciplinary proceedings through a hearings officer against licensed hearing aid dealers. (Division of Registrations, Investigations Section, Board of Hearing Aid Dealers; 12-65-115, C.R.S. 1973)
361. Aids the attorney general in prosecuting persons found to be violating state regulations regarding the practice of medicine. (Division of Registrations, Investigations Section, Board of Medical Examiners; 12-36-118 and 119, C.R.S. 1973)
362. Applies for injunctive relief through the attorney general to enjoin any person who does not possess a valid or active registered nurse license from committing any act in violation of state regulations. (Division of Registrations, Investigations Section, Board of Nursing; 12-38-224, C.R.S. 1973)

363. Applies for injunctive relief through the attorney general to enjoin any person who does not possess a valid or active practical nurse license from committing any act in violation of state regulations regarding such. (Division of Registrations, Investigations Section, Board of Nursing; 12-38-119.8, C.R.S. 1973)
364. Applies for injunctive relief through the attorney general to enjoin any person violating state regulations regarding the practice of optometry. (Division of Registrations, Investigations Section, Board of Optometric Examiners; 12-40-123, C.R.S. 1973)
365. Applies through the attorney general for injunction or other proper process to enforce any proper action of the board or to enjoin any person from violating state regulations regarding the practice of psychology. (Division of Registrations, Investigations Section, Board of Psychologist Examiners; 12-43-113, C.R.S. 1973)
366. Applies through the attorney general for injunction or other proper process to enforce any proper action of the board to enjoin any person from violating state regulations regarding mobile home dealers. (Division of Registrations, Board of Mobile Home Dealers; 12-51.5-106, C.R.S. 1973)
367. Applies through the attorney general for an injunction enjoining any person from committing an act in violation of state regulations regarding social workers. (Division of Registrations, Investigations Section, Board of Social Workers; 12-63.5-118, C.R.S. 1973)
368. Brings legal action against any person violating state laws regarding preneed funeral contracts. (Division of Insurance, Office of the Commissioner, Investigating and Licensing, Financial Examinations Sections; 12-12-115, C.R.S. 1973)
369. Conducts hearings, applies for injunctions, and takes other disciplinary action in order to enforce the laws governing architects. (Division of Registrations, State Board of Examiners of Architects; 12-4-104 (d) and (e), 113, and 119, C.R.S. 1973)

Orders

370. Orders dental hygienists to cease violations of the laws concerning their occupation. (Division of Registrations, State Board of Dental Examiners; 12-35-132, C.R.S. 1973)
371. Directs the state treasurer to make payments out of the mobile home recovery fund to qualified applicants.

(Division of Registrations, Board of Mobile Home Dealers; 12-51.5-203 and 12-51.5-204, C.R.S. 1973)

Revocations and Suspensions

372. Conducts hearings and when necessary may refuse, revoke, or suspend the registration of any subdivision developer. (Division of Real Estate, Investigations Section; 12-61-405, C.R.S. 1973)
373. Conducts hearings and when necessary may revoke or suspend the certificate of any dentist or dental hygienist licensed in the state. (Division of Registrations, Investigations Section and Dental Board; 12-35-107, 118 and 126, C.R.S. 1973)
374. Revokes the licenses of abstractors for violation of laws and regulations concerning abstractors. (Division of Registrations, Abstractors' Board of Examiners; 12-1-108, C.R.S. 1973)
375. Revokes and suspends permits, holds hearings, conducts investigations, and seeks judicial remedies in order to enforce the laws governing accountants. (Division of Registration, State Board of Accountancy; 12-2-123, 125, and 126, C.R.S. 1973)
376. Takes appropriate action to deny, suspend, or revoke the license or registration of a pharmacist. (Division of Registrations, Board of Pharmacy; 12-22-125, C.R.S. 1973)
377. Conducts investigations, holds hearings, and suspends or revokes licenses in order to enforce the laws governing dentists. (Division of Registrations, State Board of Dental Examiners; 12-35-107 (c) and (d), 12-35-117, 12-35-118, and 12-35-130, C.R.S. 1973)
378. Conducts investigations, holds hearings and suspends or revokes licenses in order to enforce the laws governing dental hygienists. (Division Registrations, State Board of Dental Examiners; 12-35-107 (c) and (d), 12-35-118 and 12-35-130, C.R.S. 1973)
379. Suspends, revokes, or refuses to renew any electrical license or registration for violation of the statutes concerning electricians. (Division of Registrations, State Electrical Board and Investigations Section; 12-23-118, C.R.S. 1973)
380. Conducts investigations of complaints; suspends, revokes or refuses to renew the certificate of registration; and causes the enjoinder or prosecution of persons concerning

- violations of the laws governing engineers and surveyors. (Division of Registrations, State Board of Registrations for Professional Engineers and Professional Land Surveyors and Investigations Section; 12-25-106 (1) through (4), C.R.S. 1973)
381. Conducts hearings for the suspension or revocation of licenses of hearing aid dealers. (Division of Registrations, Board of Hearing Aid Dealers; 12-65-103 (d), 12-65-114 and 12-65-115, C.R.S. 1973)
382. Holds hearings; causes the prosecution of; applies for injunctive relief; and suspends, revokes or refuses to renew licenses in connection with violations of the laws governing nurses. (Division of Registrations, State Board of Nursing; 12-38-108 (1), (i), (k); 12-38-113, 12-38-117, 12-38-118, 12-38-120, 12-38-124, C.R.S. 1973)
383. Conducts investigations, holds hearings, suspends, revokes or refuses to renew licenses, applies for injunctive relief in connection with violations of the laws concerning optometrists. (Division of Registrations, State Board of Optometric Examiners; 12-40-107 (1) (c), (j), 12-40-119, and 12-40-123, C.R.S. 1973)
384. Holds hearings, denies, revokes or suspends licenses, disciplines licensees; applies for injunctions; and promotes consumer protection by such means as it finds appropriate in connection with violations of the laws concerning the practice of physical therapy. (Division of Registrations, State Board of Physical Therapy and Investigations Section; 12-41-108 (2) (d) and (j), 118, 120, and 126, C.R.S. 1973)
385. Holds disciplinary hearings; denies, revokes or suspends licenses, and otherwise enforces the laws governing psychiatric technicians. (Division of Registrations, State Board of Nursing; 12-42-103, 113 and 114, C.R.S. 1973)
386. Conducts hearings upon complaints concerning the disciplining of a psychologist; denies, withholds, suspends, revokes or refuses to renew any license in connection with violations of the laws governing psychologists. (Division of Registrations, State Board of Psychologists Examiners and Investigations Section; 12-43-104, 111, and 119, C.R.S. 1973)
387. Suspends or revokes a mobile home dealer's or salesman's license as a result of a judgement requiring the board to make a payment from the Mobile Home Recovery Fund or in settlement of a claim. (Division of Registrations, Mobile Home Licensing Board; 12-51.5-205, C.R.S. 1973)

388. Holds hearings; conducts investigations, issues orders; denies, revokes or suspends licenses; and otherwise enforces the laws governing mobile home dealers. (Division of Registrations, Mobile Home Licensing Board; 12-51.5-103 (3) (d), (g), (h), (i), (j), (5) (d), (e), (f), (6) (c), (e), (f), and 12-51.5-117 through 119, C.R.S. 1973))
389. Holds hearings, revokes licenses, and otherwise enforces the laws governing plumbers. (Division of Registrations, Examining Board of Plumbers and Investigations Section; 12-58-117 through 121, C.R.S. 1973))
390. Conducts hearings, applies for injunction or prosecution; and denies, suspends, or revokes licenses in connection with violations of laws governing social workers. (Division of Registrations, State Board of Social Work Examiners and Investigations Section; 12-63.5-105 (3), 114 and 118, C.R.S. 1973))
391. Denies, suspends or revokes registrations and exemptions, holds hearings, conducts investigations, and applies for court remedies to enforce the laws governing securities. (Division of Securities, Enforcement and Examining and Licensing Sections; 11-51-111 through 113, 118, 119, 121, 122, C.R.S. 1973))
392. Removes approval of sickness and accident insurance policy forms and rates when they are based on misleading information. (Division of Insurance, Commissioner of Insurance, and Policy Analysis and Financial Examinations Sections; 10-8-102, C.R.S. 1973))
393. Revokes licenses and registrations; suspends persons from practice; reprimands, censures or otherwise disciplines persons for violations of the laws concerning nursing home administrators. (Division of Registrations, Board of Examiners of Nursing Home Administrators; 12-39-112, C.R.S. 1973))
394. Revokes or suspends licenses to sell insurance for violations of an order of the commissioner. (Division of Insurance, Commissioner of Insurance; 10-10-116, C.R.S. 1973))
395. Denies, suspends, revokes or refuses to renew licenses for violations of the laws concerning bail bondsmen. (Division of Insurance, Commissioner of Insurance; 12-7-106, C.R.S. 1973))
396. Denies, revokes or suspends licenses for violations of the laws concerning barbers and cosmetologists. (Division of Registrations, State Board of Barbers and Cosmetologists; 12-8-132, C.R.S. 1973))

397. Refuses, suspends or revokes licenses for violations of the laws concerning chiropractors. (Division of Registrations State Board of Chiropractic Examiners; 12-33-117, C.R.S. 1973)
398. Denies, suspends, or revokes licenses for violations of the laws concerning electricians. (Division of Registrations, State Electrical Board; 12-23-118, C.R.S. 1973)
399. Suspends, revokes or refuses to renew certificates of registration for violations of the laws concerning engineers and surveyors. (Division of Registrations, State Board of Registrations for Professional Engineers and Professional Land Surveyors; 12-25-106 (3) (a), C.R.S. 1973)
400. Revokes or suspends licenses for violations of the laws concerning hearing aid dealers. (Division of Registrations, Board of Hearing Aid Dealers; 12-65-103 (d), and 12-65-114, C.R.S. 1973)
401. Suspends or refuses licenses for violations of the laws concerning medical practice. (Division of Registrations, State Board of Medical Examiners; 12-36-116 and 120, C.R.S. 1973)
402. Suspends, revokes and refuses to renew licenses for violations of the laws concerning nurses. (Division of Registrations, State Board of Nursing; 12-38-118 and 119, C.R.S. 1973)
403. Suspends, revokes or refuses to renew licenses for violations of the laws concerning optometrists. (Division of Registrations, State Board of Optometric Examiners; 12-40-119, C.R.S. 1973)
404. Denies, revokes or suspends registrations or licenses for violations of the laws concerning pharmacists. (Division of Registrations, State Board of Pharmacy; 12-22-110 (1) (c) and 125, C.R.S. 1973)
405. Denies, revokes or suspends licenses for violations of the laws concerning the practice of physical therapy. (Division of Registrations, State Board of Physical Therapy; 12-41-118, C.R.S. 1973)
406. Denies, revokes, or suspends licenses for violations of the laws concerning psychiatric technicians. (Division of Registrations, State Board of Nursing; 12-42-113, C.R.S. 1973)

407. Denies, withholds, suspends, revokes or refuses to renew licenses for violations of the laws concerning psychologists. (Division of Registrations, State Board of Psychologists Examiners; 12-43-111 and 119, C.R.S. 1973)
408. Revokes licenses for violations of the laws governing plumbers. (Division of Registrations, Examining Board of Plumbers; 12-58-117, C.R.S. 1973)
409. Denies, suspends or revokes licenses for violations of the laws concerning social workers. (Division of Registrations, State Board of Social Work Examiners; 12-63.5-114, C.R.S. 1973)
410. Deposits all registration fees collected from abstractors licensed in the state. (Division of Registrations, Board of Abstractors; 12-1-111, C.R.S. 1973)

Department Totals:

\$10,000 K-C
 \$5,897 K-G
 \$3,277 K-F

467.7 FTE

DEPARTMENT OF REGULATORY AGENCIES

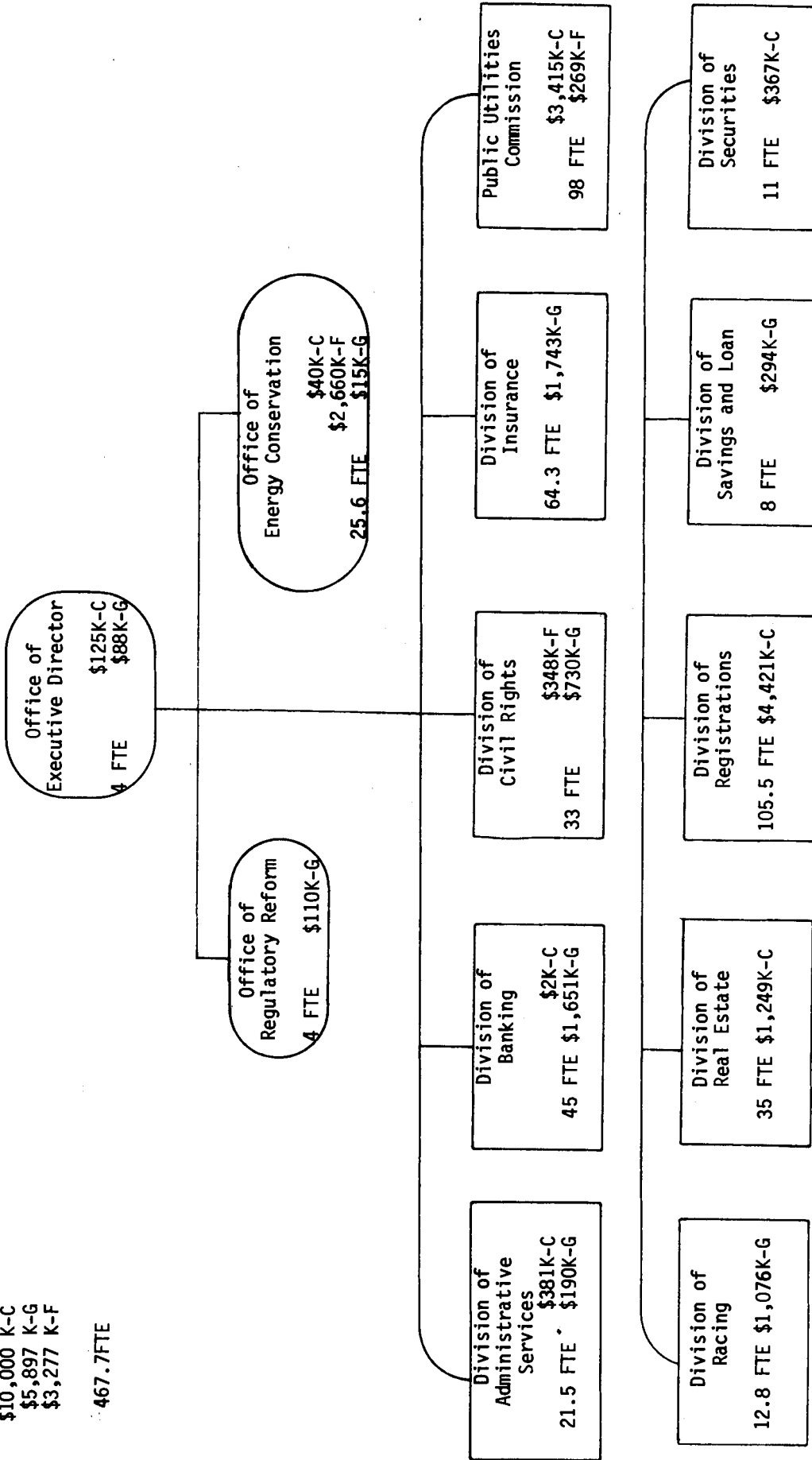

Office Totals:

\$ 213 K-G
\$ 165 K-C
\$2,660 K-F

33.6 FTE

OFFICE OF EXECUTIVE DIRECTOR

Executive Director

260a, 262b, 263b, 264a, 265a, 268b

Office of
Regulatory Reform
4 FTE \$110K-G
201a, 202a, 203a, 206a

Office of
Energy Conservation
Director
\$ 40K-C
\$2,660K-F
25.5 FTE \$ 15K-G

Office of
Public Affairs
2 FTE
204c

Administrative Unit
5.8 FTE
260c, 204c

Energy Extension
Service Unit
2 FTE
204c

Institutional
Programs Unit
5.2 FTE
204c

Commercial
Programs Unit
1.5 FTE
204c

Residential
Programs Unit
1.5 FTE
204c

Western Solar
Utilization Network
3.5 FTE
204c

Low-Income
Programs Unit
3 FTE
204c

RA-46

Division Totals:

\$381 K-C

\$190 K-G

21.5 FTE

DIVISION OF ADMINISTRATIVE SERVICES

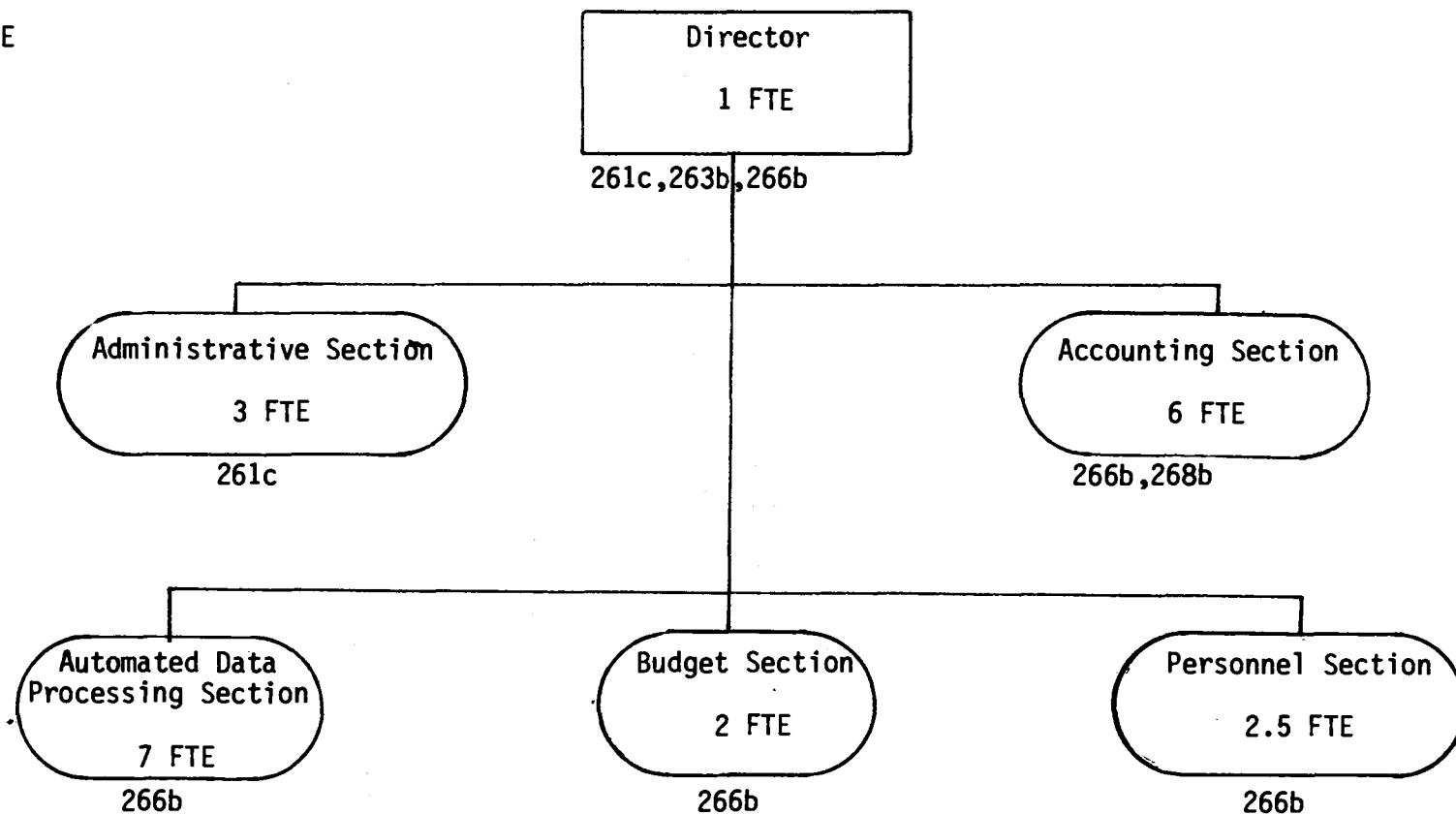

RA-47

Division Totals:

\$1,651 K-G
\$2 K-C

45 FTE

DIVISION OF BANKING

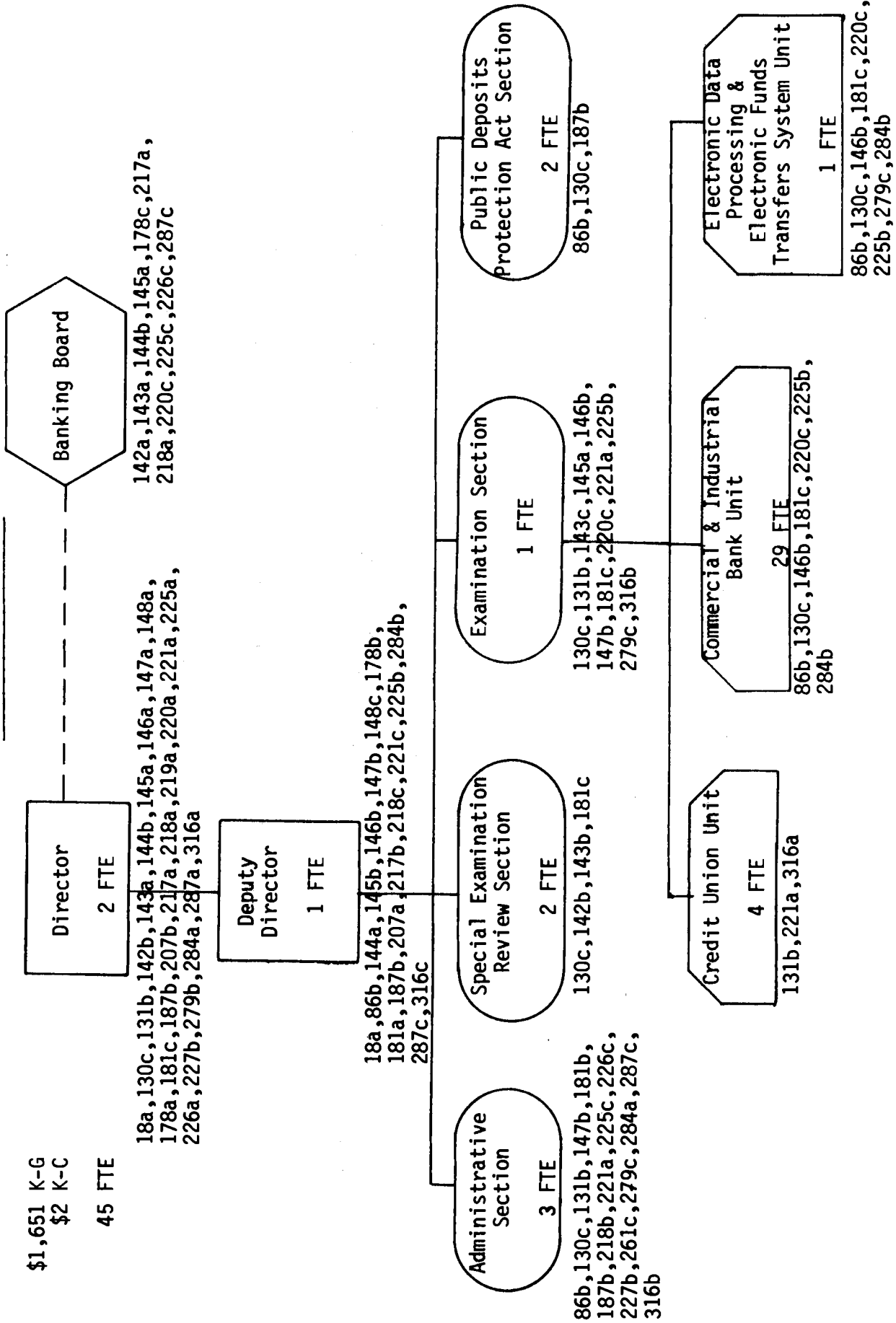

Division Totals:

\$348 K-F
\$730 K-G

33 FTE

DIVISION OF CIVIL RIGHTS

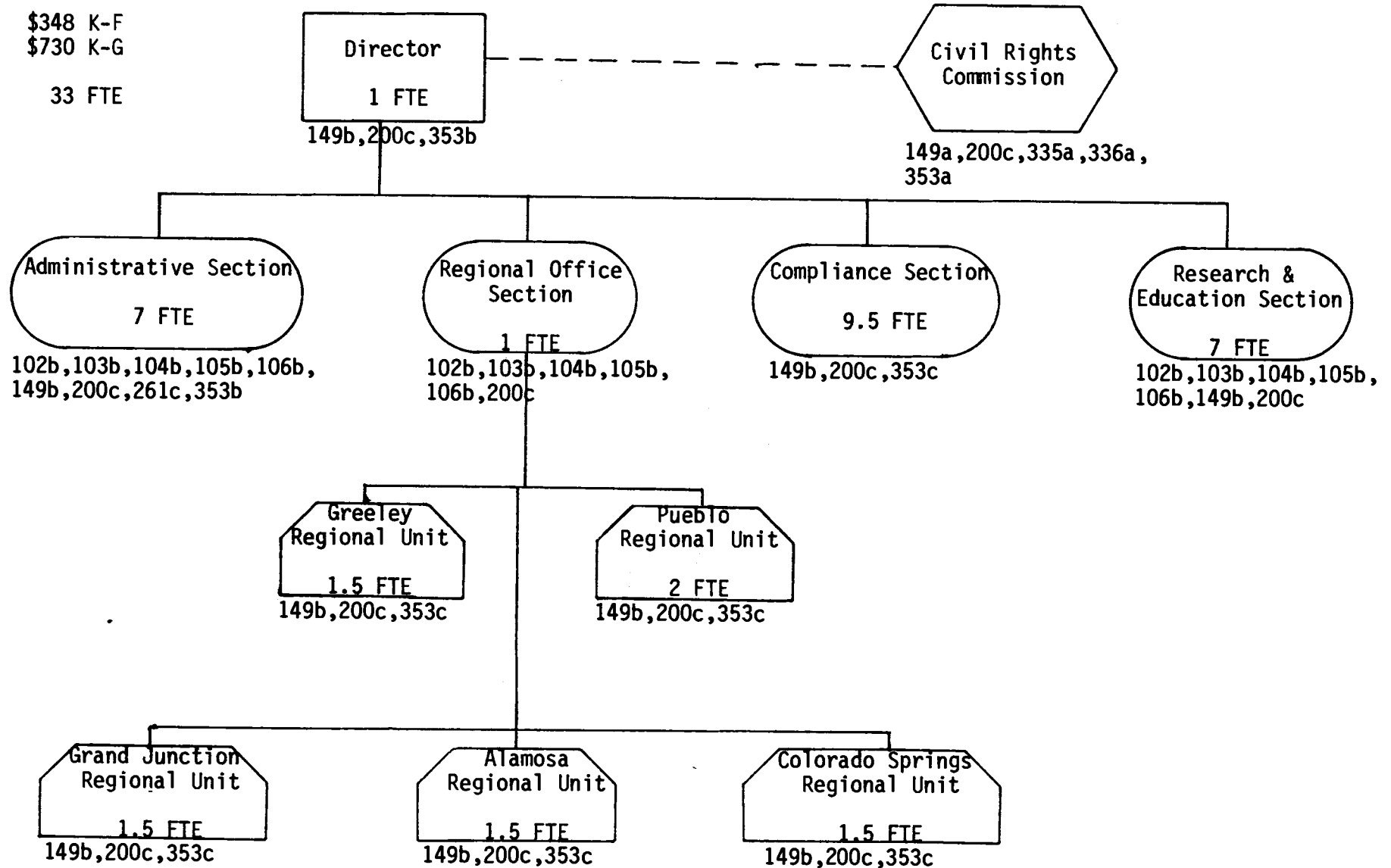

RA-49

Division Totals:

\$1,743 K-G

64.3 FTE

DIVISION OF INSURANCE

Commissioner
2.5 FTE

Insurance Board

State
Employees and
Officials Group
Insurance Board

192a

14a, 19b, 20a, 22a, 23b, 25b, 26a, 27b, 38c, 39a,
84b, 85b, 87b, 88a, 90b, 124b, 126a, 132b, 135b,
137b, 138a, 150b, 151a, 152b, 153b, 154b, 173b,
174b, 176a, 177b, 185a, 188a, 189a, 190a, 191b,
192b, 193b, 195b, 196b, 197b, 198b, 208b, 209a,
210a, 211a, 212a, 213b, 214a, 215b, 222b, 224b,
269a, 274b, 275a, 276b, 285b, 288a, 289b, 298a,
305a, 306a, 307a, 308a, 309a, 319b, 320b, 321b,
322b, 338a, 339b, 340b, 341a, 344b, 354b, 392a,
394a, 395a

RA-50

Administrative Section
4.8 FTE

153c, 154c, 175c, 192c,
195c, 197a, 276c, 285c,
320b, 321c, 325c

Investigating &
Licensing Section
11 FTE

1a, 2a, 14b, 24a, 36a, 37a, 38c,
40a, 41a, 42a, 43a, 71a, 85b,
89b, 121a, 124b, 125a, 127a, 132b,
135b, 138b, 150b, 154b, 174b, 175b,
177b, 193b, 195c, 196b, 197b, 198b,
209b, 210b, 211b, 212b, 213b, 214b,
222c, 276c, 282a, 285b, 289b, 305b,
319c, 320b, 321b, 322b, 323b, 325b,
339c, 340c, 344c, 345a, 354b, 368b

Financial
Examinations Section
23.5 FTE

3a, 19a, 21a, 23b, 25b, 27b, 38b,
72a, 87b, 89b, 90b, 124b, 132b,
133b, 134a, 135b, 137b, 150b,
151b, 152b, 153b, 154b, 173b,
174b, 191b, 192b, 193b, 194b,
196b, 197b, 198b, 208a, 213b,
215b, 222c, 224b, 274b, 276c,
285b, 289c, 317a, 318a, 319b,
320b, 322b, 323b, 325c, 344c,
368b, 392b

Policy Analysis &
Service Section
23 FTE

14b, 38c, 84b, 90c, 124b, 132b,
135b, 138b, 150b, 153b, 154b,
175a, 177a, 192b, 193b, 196b,
197b, 210b, 211b, 212b, 213b,
222c, 276c, 305b, 319b, 320b,
321b, 322b, 325c, 392b

Division Totals:

\$1,076 K-G

12.8 FTE

DIVISION OF RACING

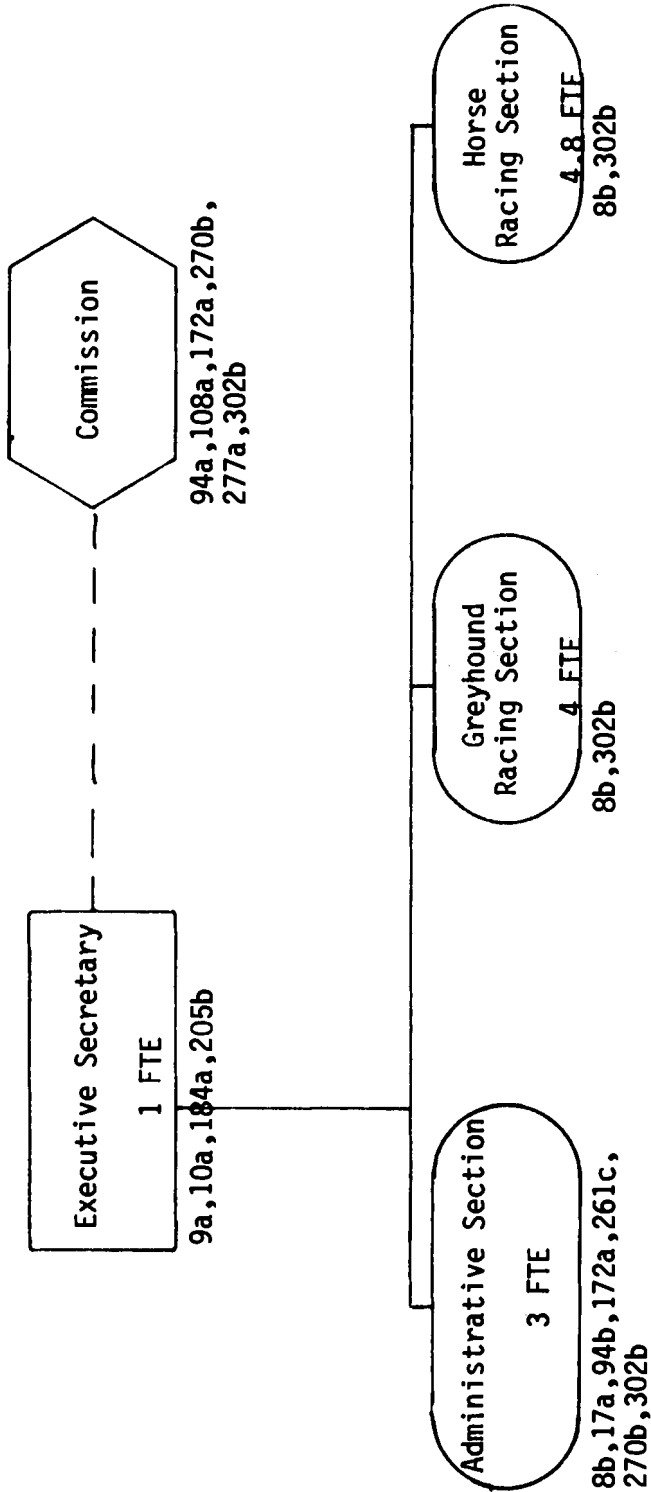

Division Totals:

\$1,249 K-C

35 FTE

DIVISION OF REAL ESTATE

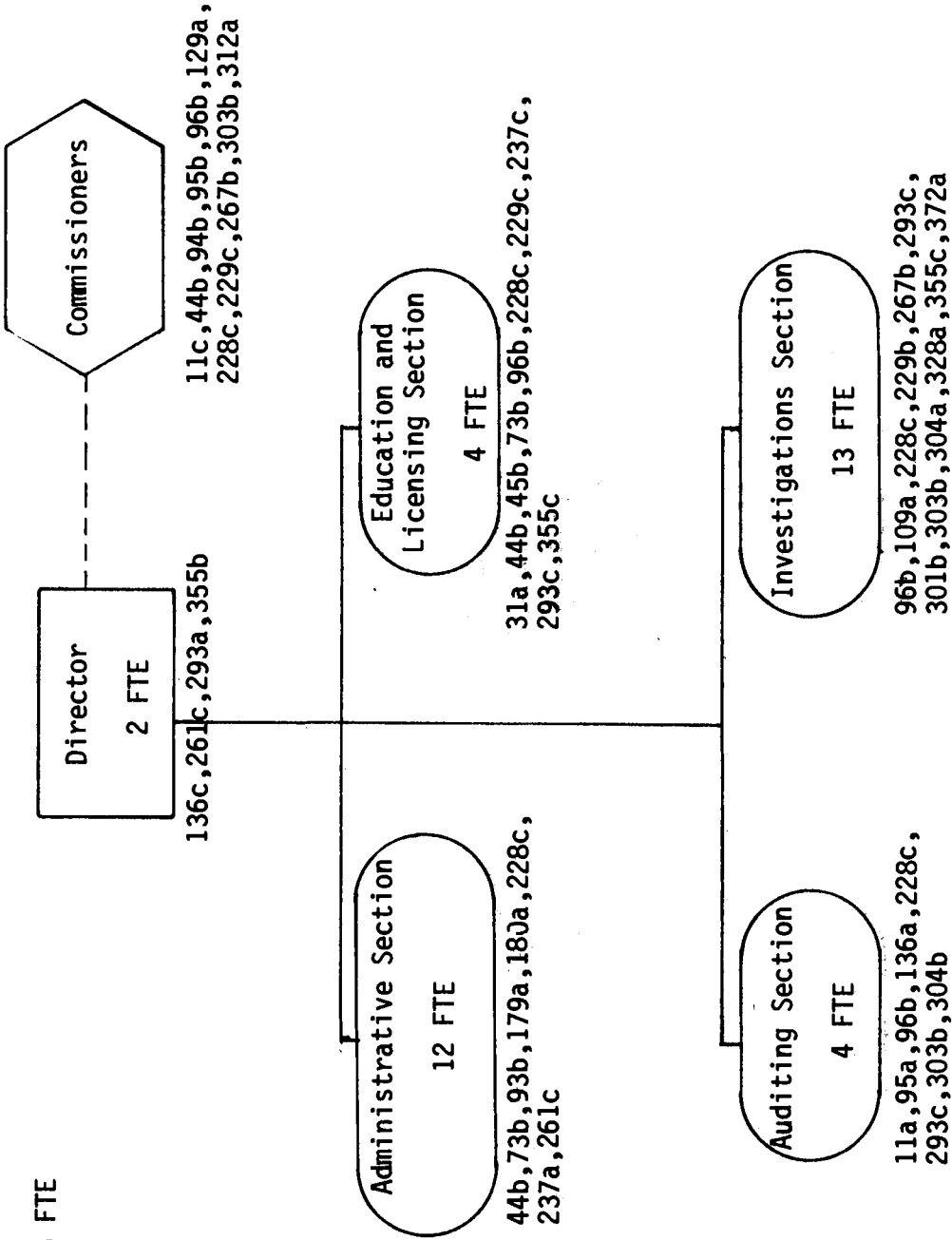

DIVISION OF REGISTRATIONS

Director's Office
1.5 FTE \$126K-G

Investigations Section
8.5 FTE \$318K-C

114b, 115b, 116b, 120b, 280b, 357b, 358b, 359b, 360b, 361b, 362b, 363b, 364b, 365b, 367b, 373b, 379b, 380b, 384b, 386b, 389b, 390b

262a

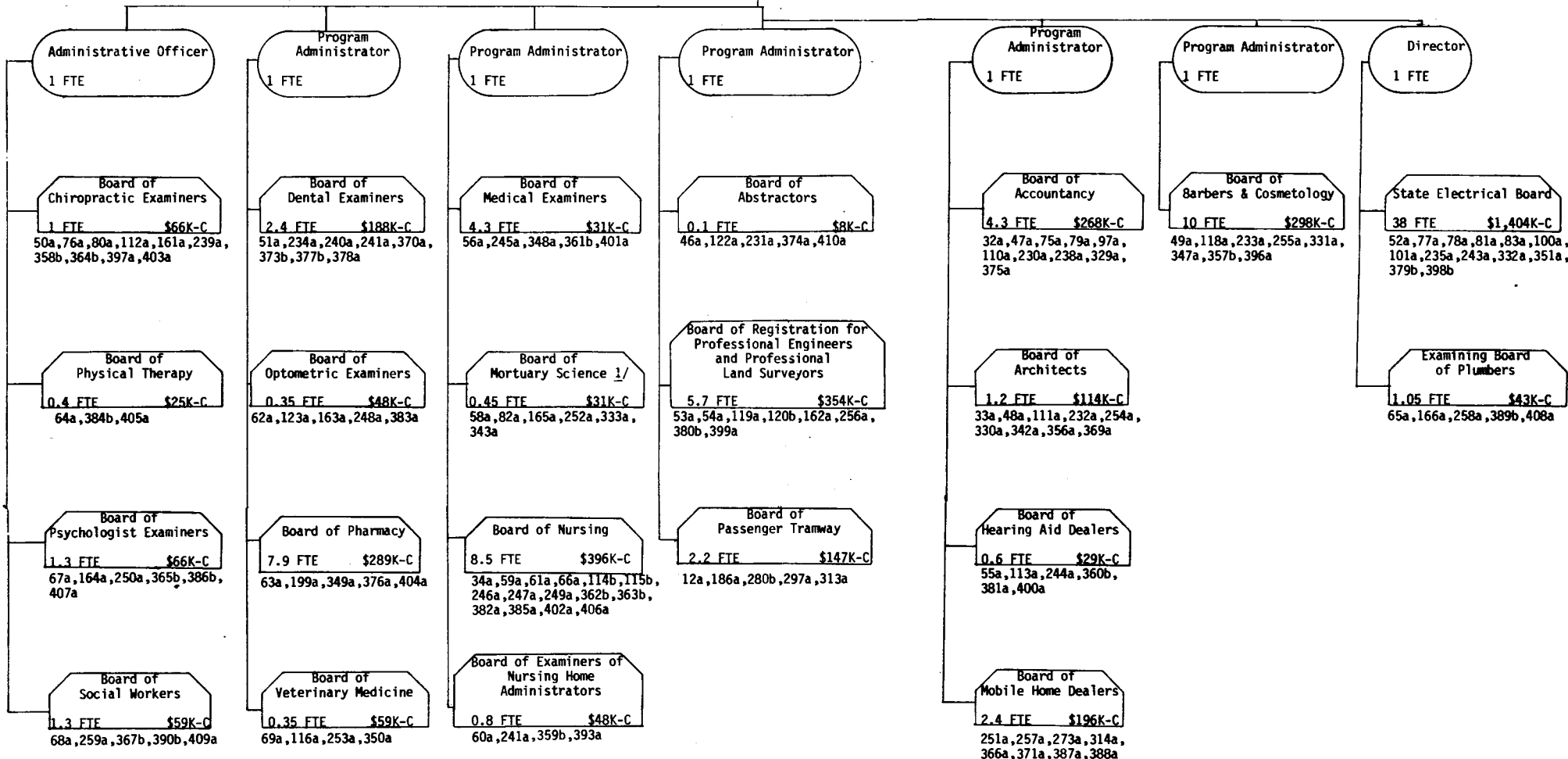

1/ The Mortuary Science Board was sunsetted on July 1, 1981.

Division Totals:

\$294 K-G

8 FTE

DIVISION OF SAVINGS AND LOAN

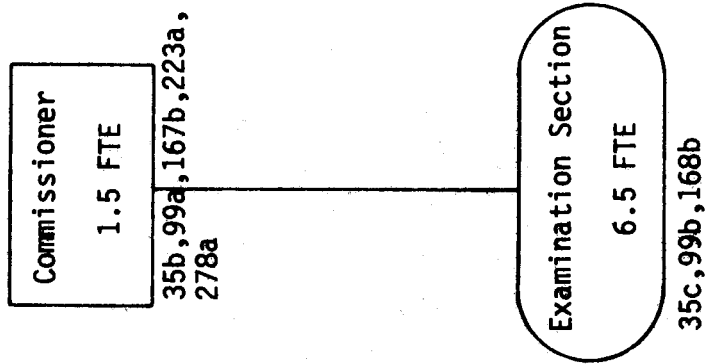

Division Totals:

\$367 K-C

11 FTE

DIVISION OF SECURITIES

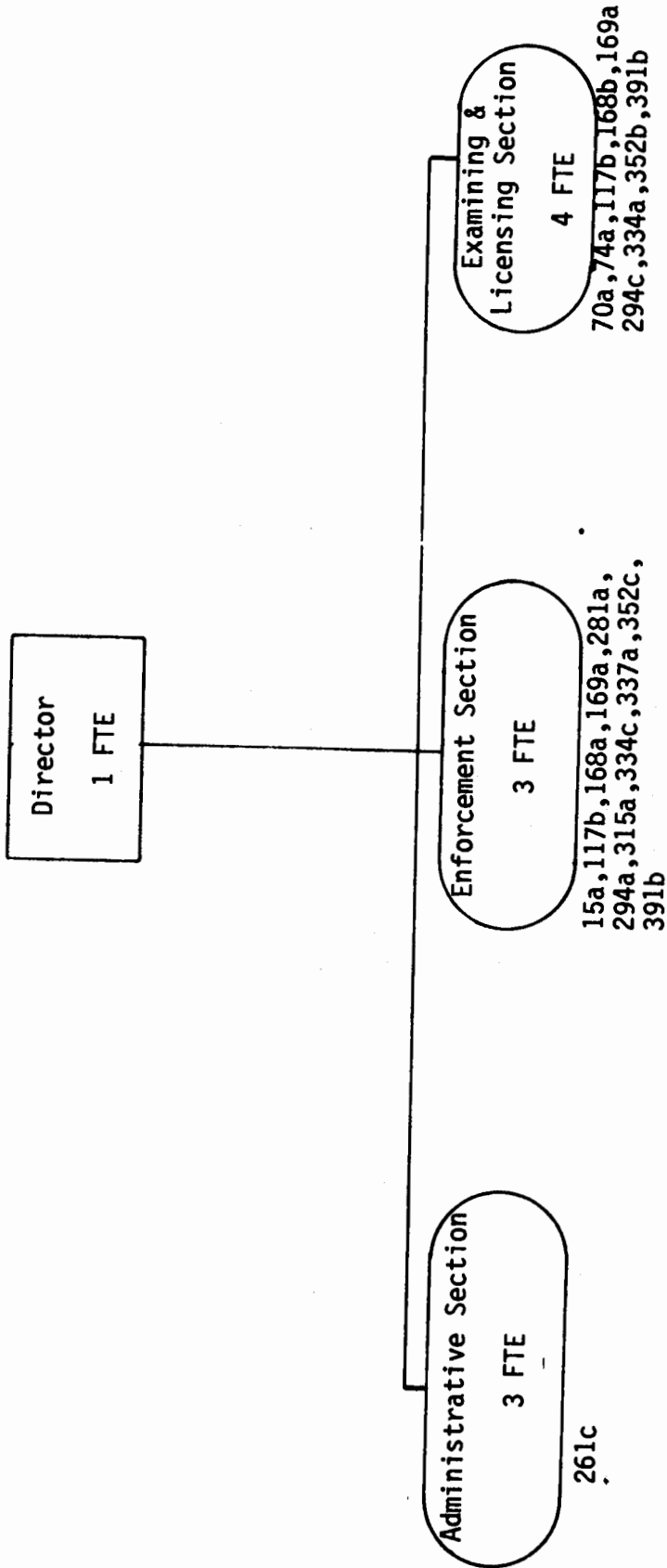

Commission Totals:

\$3,145 K-C
\$269 K-F

98 FTE

PUBLIC UTILITIES COMMISSION

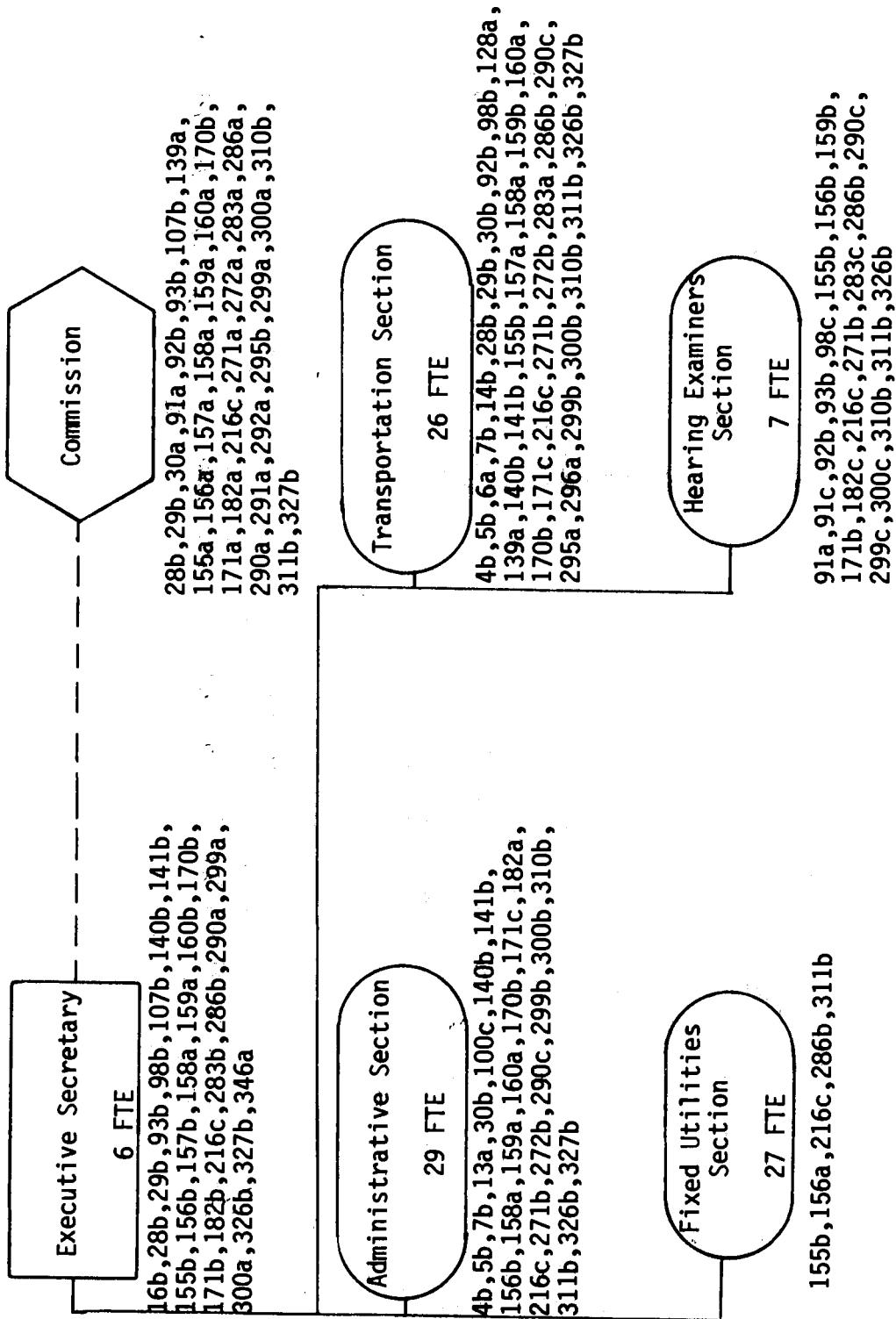

DEPARTMENT OF REVENUE

Page

Administers the Collection of Fees and Assessments

License Fees.....	REV-1
Liquor.....	REV-1
Motor Vehicle Related.....	REV-1
Other.....	REV-2
Assessments and Permits.....	REV-2
Motor Vehicle Related.....	REV-2
Other.....	REV-2

Enforces Motor Vehicle and Alcoholic Beverage Laws

Automobile.....	REV-3
Liquor.....	REV-4
Trucks.....	REV-4

Insures Administrative and Support Services

Department Expenditures.....	REV-4
Department Operations.....	REV-4
Hearings.....	REV-5
Liquor Licensing.....	REV-5
Motor Vehicles.....	REV-5
Taxpayer Protests.....	REV-5
Interagency Cooperation.....	REV-6
Personnel.....	REV-6
Records Storage.....	REV-7
Revenue Estimates.....	REV-8

Issues Licenses and Permits

Motor Vehicles.....	REV-8
Dealers.....	REV-9
Driver's License.....	REV-9
License Plates.....	REV-9
Registrations.....	REV-9
Title.....	REV-10
Other.....	REV-10

Promotes Public Safety

Accident Reports.....	REV-10
Driver Safety.....	REV-10
Identification Cards.....	REV-10

Promotes and Administers Tax Audits and
Tax Collections

Tax Audits.....	REV-11
Tax Collections.....	REV-11
Excise Tax.....	REV-11
Income Tax.....	REV-11
Inheritance, Gift, and Estate Tax.....	REV-11
Motor Vehicle.....	REV-11
Other.....	REV-12
Sales and Use.....	REV-12
Processing.....	REV-12
Automated Data Processing.....	REV-13
Delinquencies.....	REV-13
Penalty Assessments.....	REV-14
Printing and Mailing.....	REV-14
Reporting.....	REV-14
Taxpayer Assistance.....	REV-15

DEPARTMENT OF REVENUE

Administers the Collection of Fees and Assessments

License Fees

Liquor

1. Collects liquor and beer license fees. (Liquor Enforcement Division; 12-46-110 and 12-47-123, C.R.S. 1973)

Motor Vehicle Related

2. Collects drivers license fees. (Motor Vehicle Division, Drivers License Section; 42-2-112, C.R.S. 1973)
3. Collects commercial driving school license fees. (Motor Vehicle Division, Driver Improvement Section; 12-15-103 (2), C.R.S. 1973)
4. Collects motor vehicle dealer and salesman license fees. (Motor Vehicle Division, Dealer Licensing Section; 12-6-110, C.R.S. 1973)
5. Collects motor vehicle manufacturers license fees. (Motor Vehicle Division, Dealer Licensing Section; 12-6-110, C.R.S. 1973)
6. Collects special fuel distributors license fees. (Taxpayer Service Division, Accounting Services Major Tax Section; 39-27-204, C.R.S. 1973)
7. Collects motor vehicle title fees. (Motor Vehicle Division, Titles Section; 42-6-135, C.R.S. 1973)
8. Collects overdue trailer permit fees. (Ports of Entry Division; 42-4-409, C.R.S. 1973)
9. Collects motor vehicle emission inspection sticker fees. (Motor Vehicle Division, Emissions Section; 42-4-308, C.R.S. 1973)

10. Collects specialized motor vehicle license plate fees. (Motor Vehicle Division, Registration Section; 42-3-112.1, C.R.S. 1973)

Other

11. Collects restaurant license and inspection fees. (Operations Division, Cashier Section; 12-44-208, C.R.S. 1973)
12. Collects store license fees. (Taxpayer Service Division, Accounting Services Major Tax Section; 12-49-103, C.R.S. 1973)
13. Collects cigarette wholesalers license fees. (Taxpayer Service Division, Accounting Services Major Tax Section; 39-28-102, C.R.S. 1973)
14. Collects bedding stamp license fees. (Operations Division, Cashier Section; 25-5-309, C.R.S. 1973)

Assessments and Permits

Motor Vehicle Related

15. Collects motor vehicle registration and license plate fees. (Motor Vehicle Division, Registration Section; 42-3-123, C.R.S. 1973)
16. Collects special fuel permit fees. (Port of Entry Division and Taxpayer Service Division, Accounting Services Major Tax Section; 39-27-205, C.R.S. 1973)
17. Administers motor vehicle financial responsibility obligations. (Motor Vehicle Division, Driver Improvement Section; 42-7-506 (2), C.R.S. 1973)
18. Collects motor vehicle penalty assessments. (Motor Vehicle Division, Master Files Section; 42-4-1501, C.R.S. 1973)

Other

19. Collects plumber inspection fees. (Operations Division, Cashier Section; 12-58-112, C.R.S. 1973)
20. Collects Public Utility Commission fees. (Operations Division, Port of Entry Division; 40-2-110 through 114, C.R.S. 1973)

21. Collects litter assessments. (Taxpayer Service Division, Accounting Services Major Tax Section; 24-32-1010 and 18-4-511, C.R.S. 1973)
22. Collects identification card fees. (Motor Vehicle Division, Drivers License Section; 42-2-406, C.R.S. 1973)
23. Collects bedding inspection fees. (Operations Division, Cashier Section; 25-5-310, C.R.S. 1973)
24. Collects boiler inspection fees. (Operations Division, Cashier Section; 9-4-109, C.R.S. 1973)

Enforces Motor Vehicle and Alcoholic Beverage Laws

Automobiles

25. Calibrates the exhaust gas analyzers of every licensed inspection and readjustment station every 60 days. (Motor Vehicle Division, Emissions Section; 42-4-308, C.R.S. 1973)
26. Conducts inspections of licensed inspection and readjustment stations. (Motor Vehicle Division, Emissions Section; 42-4-308, C.R.S. 1973)
27. Restrains, detains, or impounds vehicles until any tax or license fee imposed by law is paid or until compliance is had with any tax or regulatory law or regulation issued thereunder. (Port of Entry Division; 42-8-104 (2), C.R.S. 1973)
28. Investigates any suspected or alleged violation by any motor vehicle dealer, wholesaler, motor vehicle salesman, or used motor vehicle dealer licensee. (Motor Vehicle Division, Dealer Licensing Section; 12-6-104 (3) (f), C.R.S. 1973)
29. Enforces the motor vehicle laws including false and altered drivers licenses, driving under suspension, habitual offenders, incorrect records, and stolen drivers license documents. (Motor Vehicle Division, Enforcement Section; 42-2-103, 42-2-130, and 42-2-128, C.R.S. 1973)
30. Investigates auto dealerships for the proper use of temporary registration permits and dealer license plates. (Motor Vehicle Division, Dealer Licensing Section; 12-6-104 (3) (f), C.R.S. 1973)
31. Collects taxes from owners of vehicles at the port of entry who are not properly certified or permitted by the PUC or which have not established an account with the Department

of Revenue for the payment of taxes. (Port of Entry Division; 42-8-106 (2), C.R.S. 1973)

Liquor

32. Enforces the statutory rules and regulations pertaining to alcoholic beverages and intoxicating liquors. (Liquor Enforcement Division, Office of the Chief; 12-47-105, C.R.S. 1973)

Trucks

33. Enforces the Colorado size and weight limitation statutory provisions on vehicles operating on Colorado highways with the use of scales at port of entry inspection stations and with the use of mobile units and portable scales. (Port of Entry Division; 42-4-301 and 42-4-401, C.R.S. 1973)

Insures Administrative and Support Services

Department Expenditures

34. Maintains an accounting of the expenditures in the department's appropriation; processes and pays all obligations incurred by the department; processes the department's payroll; prepares the department's budget; and maintains records of fixed assets and consumable inventories acquired by the department. (Executive Director's Office, Fiscal Staff; 24-35-103, C.R.S. 1973)
35. Ascertains the extent to which fixed assets are accounted for and safeguarded within the department. (Executive Director's Office, Internal Auditor; 39-21-112, C.R.S. 1973)
36. Reviews and appraises the adequacy and application of the department's accounting and operating controls; determines the reliability of management data developed within the department and the department's compliance with established management policies and procedures. (Executive Director's Office, Internal Auditor; 39-21-112, C.R.S. 1973)

Department Operations

37. Establishes and monitors all department operations to verify and record all documents and transactions. (Operations Division, Office of the Chief; 24-35-113, C.R.S. 1973)
38. Provides telecommunications support to department locations

throughout the state. (Management Information Services Division; 24-35-102 and 24-35-108, C.R.S. 1973)

39. Provides maintenance and custodial services to the port of entry stations and departmental service centers. (Motor Vehicle Division, Building Services Section; no state statutory mandate.)

Hearings

Liquor Licensing

40. Conducts formal hearings and makes determinations on complaints, appeals, and protests regarding the liquor licensing functions. (Executive Director's Office; 12-46-105 and 12-47-105, C.R.S. 1973)

Motor Vehicles

41. Conducts hearings annually to determine the maximum fees to be charged for an emission inspection. (Executive Director's Office; 42-4-308, C.R.S. 1973)
42. Conducts hearings on violations by inspection readjustment stations. (Executive Director's Office; 42-4-308, C.R.S. 1973)
43. Conducts formal hearings on suspected violations of motor vehicle dealers laws. (Executive Director's Office, Dealer Licensing Board; 12-6-104, C.R.S. 1973)
44. Conducts formal hearings on drivers license point suspensions, revocations, financial responsibility, implied consent actions, cancellations, and denial of drivers license for medical and physical inabilities. (Executive Director's Office, Motor Vehicle Hearings; 42-2-123, C.R.S. 1973)

Taxpayer Protests

45. Conducts informal hearings to attempt to resolve taxpayer protests of adjustments made in various tax liabilities. (Executive Director's Office; Tax Conferee Section; 39-21-103, C.R.S. 1973)
46. Conducts formal hearings for taxpayer protests not settled in informal conferences. (Executive Director's Office; 39-21-103, C.R.S. 1973)

Interagency Cooperation

47. Collects any tax levied by local government when the same kind of tax is also collected by the department and when a contract has been entered into with the local government for the collection of such tax. (Taxation Division, Taxpayer Service Division, Operations Division; 24-35-110, C.R.S. 1973)
48. Assists the Division of Housing in the control of factory-built houses, including mobile homes, entering the state. (Port of Entry Division; 42-8-108, C.R.S. 1973)
49. Assists the Department of Agriculture in enforcing laws regarding agriculture inspections and issues applications for permits to move agricultural commodities. (Port of Entry Division; 42-8-108, C.R.S. 1973)
50. Assists the Department of Agriculture in enforcing the health and brand inspection laws during the transportation of livestock. (Port of Entry Division; 42-8-108, C.R.S. 1973)
51. Assists licensees, local licensing authorities, and law enforcement agencies in the enforcement of state and local liquor laws. (Liquor Enforcement Division; 12-46-105 (2) (a) and 12-47-105 (2) (a), C.R.S. 1973)
52. Provides access to a statewide central file of driver and vehicle records. (Motor Vehicle Division, Master Files Section; 42-1-217, C.R.S. 1973)
53. Provides on-line communications support to the CBI and Denver Police Department regarding vehicle and driver information. (Management Information Services Division, Computer Unit; 42-1-217, C.R.S. 1973)
54. Enforces Public Utilities Commission laws, rules and regulations pertaining to common, private, and interstate trucking; collects fees on PUC permits issued. (Port of Entry Division; 42-8-108, C.R.S. 1973)
55. Supervises the 63 county clerk and recorder offices which act as agents for the Department of Revenue in the collection of registration fees and ownership taxes on motor vehicles. (Motor Vehicle Division, Registration Section; 42-1-210, C.R.S. 1973)

Personnel

56. Studies the department's programs, operating systems, and

procedures in order to identify problems, recommend improvements, and improve operating efficiency. (Executive Director's Office, Management Analysis; 39-21-112, C.R.S. 1973)

57. Provides the following services for management: classification audits and surveys, interpretation of departmental policies and state personnel rules, development of performance standards and performance evaluations, and employment testing. (Executive Director's Office, Personnel Staff; 24-35-113, C.R.S. 1973)
58. Provides the following services to department employees: counseling regarding insurance, retirement counseling, fund drives, and health and safety matters, conducting orientation sessions and other training, and assisting in the interpretation of departmental policies and personnel rules for state employees. (Executive Director's Office, Personnel Staff and Motor Vehicle Division, Assistant Director's Office; 24-35-113, C.R.S. 1973)
59. Conducts a continuing training program for employees concerning statutes, regulations, operating methods, procedures, and policies. (Taxation Division, Policy and Training Section and Motor Vehicle Division, Assistant Director's Office; 39-21-112, C.R.S. 1973)

Records Storage

60. Maintains centralized files of all tax returns filed with the Department of Revenue for the time period required by law. (Operations Division; 39-21-113 (3), C.R.S. 1973)
61. Compiles and maintains a statewide central file of all driver records. (Motor Vehicle Division, Master Files Section; 42-1-217, C.R.S. 1973)
62. Maintains a permanent record of all motor vehicle accident reports. (Motor Vehicle Division, Driver Improvement Section; 42-4-1406, C.R.S. 1973)
63. Maintains records of tax accounts and activities pertaining to tax liability, payments, overpayments, and refunds for the following taxes: income, cigarette, use, gross ton mile, withholding, state sales, city sales, county sales, RTD sales, motor and special fuel, retailers use, severance, and oil and gas withholding. (Taxpayer Service Division, Accounting Services Major Tax Section; 39-21-113 (3), C.R.S. 1973)
64. Maintains, records, updates, and files for all tax accounts all applications, licenses, violations, changes of

ownership, and notices of accounts out of business. (Operations Division, Records Management and Support Section; 39-21-113 (3), C.R.S. 1973)

65. Compiles and maintains a statewide central file of all vehicle records. (Motor Vehicle Division, Master Files Section and Operations Division, Coding Unit; 42-1-206, C.R.S. 1973)

Revenue Estimates

66. Prepares state tax revenue estimates for use by the executive and legislative branches. (Executive Director's Office, Research and Statistics Staff and Taxpayer Service Division, Special Projects Section; 24-35-102, C.R.S. 1973)
67. Compiles, analyzes, evaluates, and correlates revenue statistics and economic data to conduct studies of taxation and related economic issues. (Executive Director's Office, Research and Statistics Staff; 39-21-113 (5), C.R.S. 1973)

Issues Licenses and Permits

Motor Vehicles

68. Issues special fuel permits. (Taxpayer Service Division, Accounting Services Major Tax Section; 39-27-205, C.R.S. 1973)
69. Issues special fuel distributors licenses. (Taxpayer Service Division, Accounting Services Major Tax Section; 39-27-104, C.R.S. 1973)
70. Issues overwide trailer permits. (Port of Entry Division; 42-4-409, C.R.S. 1973)
71. Issues motor vehicle manufacturers licenses. (Motor Vehicle Division, Dealer Licensing Section; 12-6-108, C.R.S. 1973)
72. Issues motor vehicle emission inspection mechanics licenses. (Motor Vehicle Division, Emissions Section; 42-4-308, C.R.S. 1973)
73. Issues motor vehicle dealers and salesperson licenses. (Motor Vehicle Division, Dealer Licensing Section; 12-6-108, C.R.S. 1973)
74. Issues emission inspection station licenses. (Motor Vehicle Division, Emissions Section; 42-4-308, C.R.S. 1973)

Dealers

75. Licenses and regulates motor vehicle dealers, used motor vehicle dealers, wholesalers, and salespersons and investigates any suspected or alleged violation of the licensee law or rules or regulations promulgated by the dealer licensing board. (Executive Director's Office, Dealer Licensing Board; 12-6-105, C.R.S. 1973)

Driver Licenses

76. Processes requests for name and address changes on drivers licenses and ID cards. (Motor Vehicle Division, Drivers License Section; 42-2-117, C.R.S. 1973)
77. Conducts statewide testing of applicants for a Colorado drivers license, and approves or disapproves the granting of a license. (Motor Vehicle Division, Drivers License Section; 42-2-110, C.R.S. 1973)
78. Issues duplicate licenses in the case of a lost, stolen, or mutilated drivers license. (Motor Vehicle Division, Drivers License Section; 42-2-115, C.R.S. 1973)
79. Advises the department on medical criteria and vision standards relating to the licensing of automobile drivers. (Executive Director's Office, Medical Advisory Board; 42-2-301, C.R.S. 1973)
80. Issues motor vehicle drivers licenses. (Motor Vehicle Division, Drivers License Section; 42-2-103, C.R.S. 1973)

License Plates

81. Issues all vehicle license plates. (Motor Vehicle Division, Registration Section; 42-3-112, C.R.S. 1973)

Registrations

82. Registers and collects all fees for apportionable registration of interstate vehicles. (Motor Vehicle Division, Registration Section; 42-3-117, C.R.S. 1973)

83. Registers all motor vehicles. (Motor Vehicle Division, Registration Section; 42-3-102, C.R.S. 1973)

Title

84. Issues titles for all motor vehicles purchased for location in Colorado. (Motor Vehicle Division, Titles Section; 42-6-106, C.R.S. 1973)

Other

85. Issues cigarette wholesalers licenses. (Taxpayer Service Division, Accounting Services Major Tax Section; 39-28-102, C.R.S. 1973)
86. Issues liquor licenses. (Liquor Enforcement Division, Licensing and Taxation Section; 12-47-105, C.R.S. 1973)
87. Issues restaurant licenses. (Taxpayer Service Division, Accounting Services Major Tax Section; 12-46-409, C.R.S. 1973)
88. Issues store licenses. (Taxpayer Service Division, Accounting Services Major Tax Section; 12-49-104, C.R.S. 1973)

Promotes Public Safety

Accident Reports

89. Publishes annually statistical information based on the tabulation and analysis of accident reports based on the number, cause, and location of highway accidents. (Motor Vehicle Division, Driver Improvement Section 42-1-208, C.R.S. 1973)

Driver Safety

90. Conducts driver improvement courses for drivers whose licenses have been suspended or who have been enrolled by the courts. (Executive Director's Office, Motor Vehicle Hearings; 42-4-1513, C.R.S. 1973)

Identification Cards

91. Issues Colorado non-driver identification cards. (Motor Vehicle Division, Drivers License Section; 42-2-402, C.R.S. 1973)

Promotes and Administers Tax Audits and Tax Collections

Tax Audits

92. Selects corporate and individual tax returns to audit through a computer-assisted audit selection program which covers all types of taxes and taxpayers. (Taxation Division, Audit Selection Unit; 24-35-108, C.R.S. 1973)
93. Conducts investigations of alleged fraudulent violations of state tax laws. (Taxation Division, Compliance Investigation Section; 24-35-108, C.R.S. 1973)
94. Conducts the auditing of liquor excise taxes imposed on the liquor industry. (Liquor Enforcement Division, Enforcement Program; 12-47-109, C.R.S. 1973)
95. Conducts routine auditing of taxpayers to determine the actual tax liability in relation to the liability filed. (Taxation Division, Field Audit Unit; 24-35-108, C.R.S. 1973)

Tax Collections

Excise Tax

96. Collects alcoholic beverage excise taxes. (Liquor Enforcement Division; 12-47-127, C.R.S. 1973)

Income Tax

97. Collects income taxes, both individual and corporate. (Taxpayer Service Division, Accounting Services Income Tax Section; 39-22-104, C.R.S. 1973)

Inheritance, Gift, and Estate Tax

98. Collects inheritance and gift taxes. (Taxpayer Service Division, Estate Tax Section; 39-23-104 and 39-25-101, C.R.S. 1973)
99. Collects estate tax. (Taxpayer Service Division, Estate Tax Section; 39-23.5-103, C.R.S. 1973)

Motor Vehicle

100. Collects motor vehicle specific ownership taxes. (Motor Vehicle Division, Registration Section; 42-3-101, C.R.S.)

1973)

101. Collects gross ton mile tax. (Taxpayer Service Division, Accounting Services Major Tax Section and Ports of Entry Division; 42-3-123, C.R.S. 1973)

Other

102. Collects severance taxes. (Taxpayer Service Division, Accounting Services Major Tax Section; 39-29-101 et seq., C.R.S. 1973)

Sales and Use

103. Collects RTD sales taxes. (Taxpayer Service Division, Accounting Services Major Tax Section; 32-9-120, C.R.S. 1973)
104. Collects city sales taxes. (Taxpayer Service Division, Accounting Services Major Tax Section; 29-2-101, C.R.S. 1973)
105. Collects county sales taxes. (Taxpayer Service Division, Accounting Services Major Tax Section; 29-2-101, C.R.S. 1973)
106. Collects state sales taxes. (Taxpayer Service Division, Accounting Services Major Tax Section; 39-26-104, C.R.S. 1973).
107. Collects gasohol taxes. (Taxpayer Service Division, Accounting Services Major Tax Section; 35-39-104.5 (1), C.R.S. 1973)
108. Collects motor fuel taxes. (Taxpayer Service Division, Accounting Services Major Tax Section; 39-27-102, C.R.S. 1973)
109. Collects use taxes. (Taxpayer Service Division, Accounting Services Major Tax Section; 39-26-204, C.R.S. 1973)
110. Collects cigarette taxes. (Taxpayer Service Division, Accounting Services Major Tax Section; 39-28-103, C.R.S. 1973)

Processing

111. Processes amended returns and tax returns which have not been completed correctly. (Taxpayer Service Division, Accounting Services, Major Tax and Income Tax Sections and Operations Division, Clearing and Verifying Sections;

39-21-108, C.R.S. 1973)

112. Enters data from taxpayer documents. (Management Information Services Division; 39-21-113 (3), C.R.S. 1973)
113. Deposits and accounts for all money received by the Department of Revenue. (Operations Division, Cashier and Verifying Sections; 24-35-101, C.R.S. 1973)
114. Processes distraint warrants for collection of delinquent taxes and the subsequent return of the final payment. (Operations Division, Distraint Warrant Control Unit; 24-35-109, C.R.S. 1973)
115. Implements and monitors state tax processing systems to accelerate the deposit of checks to meet cash management objectives. (Operations Division, Cashier Section 24-35-106, C.R.S. 1973)
116. Records, controls, monitors, and accounts for all state tax and fee collections and payments of refunds. (Executive Director's Office, Controller Section; 24-36-103, C.R.S. 1973)
117. Verifies documents for completeness and accuracy prior to data entry. (Operations Division; 24-35-102, C.R.S. 1973)

AUTOMATED DATA PROCESSING

118. Maintains and updates computer data files. (Management Information Services Division; 24-35-102 and ~~24-35-108~~, C.R.S. 1973)
119. Designs automated systems and programs to facilitate the efficient storage and retrieval of information. (Management Information Services Division, Systems and Programming Section; 24-35-102 and 24-35-108, C.R.S. 1973)

Delinquencies

120. Contacts delinquent taxpayers throughout the state and executes distraint warrants to collect the taxes. (Taxation Division, Collection and Enforcement Section; 39-21-114, C.R.S. 1973)
121. Conducts sales of claimed property at public auction of property seized for the payment of delinquent taxes. (Taxation Division and Liquor Enforcement Division; 24-35-109, C.R.S. 1973)

122. Assists the Attorney General in the prosecution of any legal actions commenced for the collection of any delinquent tax, assessment, or license within the Department of Revenue. (Executive Director's Office, Tax Conferee Section; 24-35-108 (1) (b), C.R.S. 1973)

Penalty Assessments

123. Processes all penalty assessment tickets issued by the Colorado State Patrol and other law enforcement agencies. (Motor Vehicle Division, Master Files Section 42-4-1510, C.R.S. 1973)

Printing and Mailing

124. Prepares preprinted tax returns for mailing to taxpayers. (Management Information Services Division; 24-35-102 and 24-35-108, C.R.S. 1973)
125. Prints tax refund checks. (Management Information Services Division, Computer Unit; 39-21-108, C.R.S. 1973)
126. Prepares, inserts, and mails all tax billings, correspondence and assessments. (Operations Division, Records Management and Support Section, Services Unit; 24-35-102, C.R.S. 1973)

Reporting

127. Prepares the annual report of taxes collected and the discharge of all responsibilities of the Department of Revenue assigned by law or directive. (Executive Director's Office, Research and Statistics Staff; 24-35-102, C.R.S. 1973)
128. Prepares periodic reports for the federal government as well as other governmental agencies covering state tax collections. (Executive Director's Office, Research and Statistics Staff; 39-21-113 (5), C.R.S. 1973)
129. Reports to the State Treasurer of all monies received by the Department of Revenue. (Executive Director's Office, Controller Section; 24-36-103, C.R.S. 1973)
130. Advises the State Treasurer biannually of the amounts apportioned to each city and county of all specific ownership taxes collected. (Motor Vehicle Division, Assistant Director of Vehicle Services; 42-3-106 (8), C.R.S. 1973)

Taxpayer Assistance

131. Provides classes to new businesses on the preparation of tax returns. (Taxpayer Service Division, General Information Section; 24-35-101 and 24-35-102, C.R.S. 1973)
132. Operates district offices statewide to provide taxpayer assistance. (Taxpayer Service Division, Tax Services District Offices; 24-35-101 and 24-35-102, C.R.S. 1973)
133. Consults with industry officials to assure compliance with state taxation laws, rules, and regulations, and to address mutual problems relating to the industry and the Revenue Department. (Taxpayer Service Division, Accounting Services Major Tax and Special Projects Sections 24-35-101 and 24-35-102, C.R.S. 1973)
134. Trains volunteers to assist low income and elderly people in the preparation of income tax returns. (Taxpayer Service Division, General Information Section; 24-35-101 and 24-35-102, C.R.S. 1973)

Department Totals:

\$13,939 K-G
\$17,666 K-HUTF
\$1,472 K-C
1,340 FTE

Colorado
Dealer
Licensing Board
\$5K-C

DEPARTMENT OF REVENUE

Medical
Advisory Board

Executive
Director
82.3 FTE \$861K-G
\$1,961K-HUTF

Deputy Director

Operations Division
184.8 FTE \$3,380K-G
\$1,013K-HUTF

Management Information
Services Division
209.7 FTE \$2,349K-G
\$2,848K-HUTF

Taxpayer Service
Division
112.5 FTE \$1,923K-G
\$407K-HUTF

Taxation Division
162 FTE \$4,798K-G
\$301K-HUTF

Motor Vehicle Division
490.6 FTE \$45K-G
\$1,467K-C
\$8,709K-HUTF

Liquor Enforcement
Division
20.6 FTE \$483K-G

Port of Entry
Division
77.5FTE \$2,427K-HUTF

REV-16

Office Totals:

\$861 K-G
\$1,961 K-HUTF
82.3 FTE

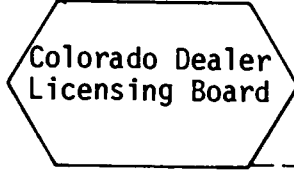

43a,75a

OFFICE OF EXECUTIVE DIRECTOR

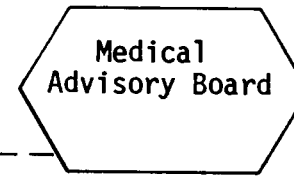

79a

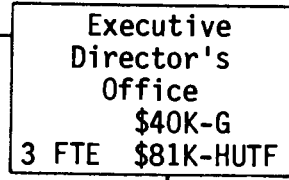

40b,41a,42b,46b

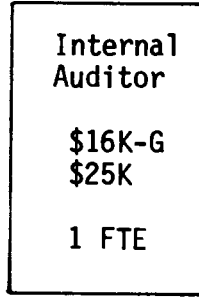

35a,36a

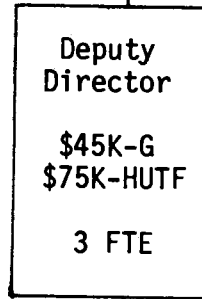

40b,42b,46b

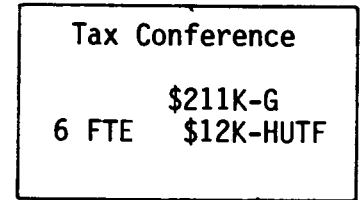

45a,122a

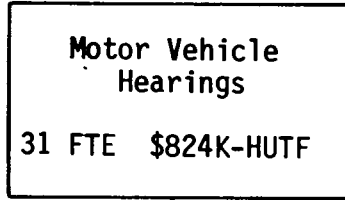

44a,90a

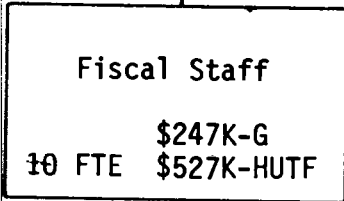

34a

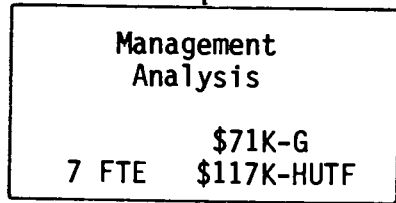

56a

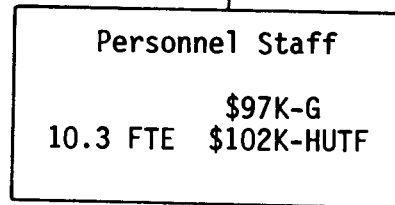

57a,58a

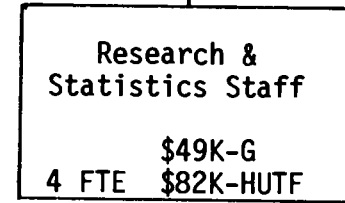

66a,67a,127a,128a

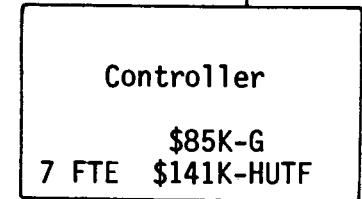

116a,129a

Division Totals:

\$583 K-G

20.6 FTE

LIQUOR ENFORCEMENT DIVISION

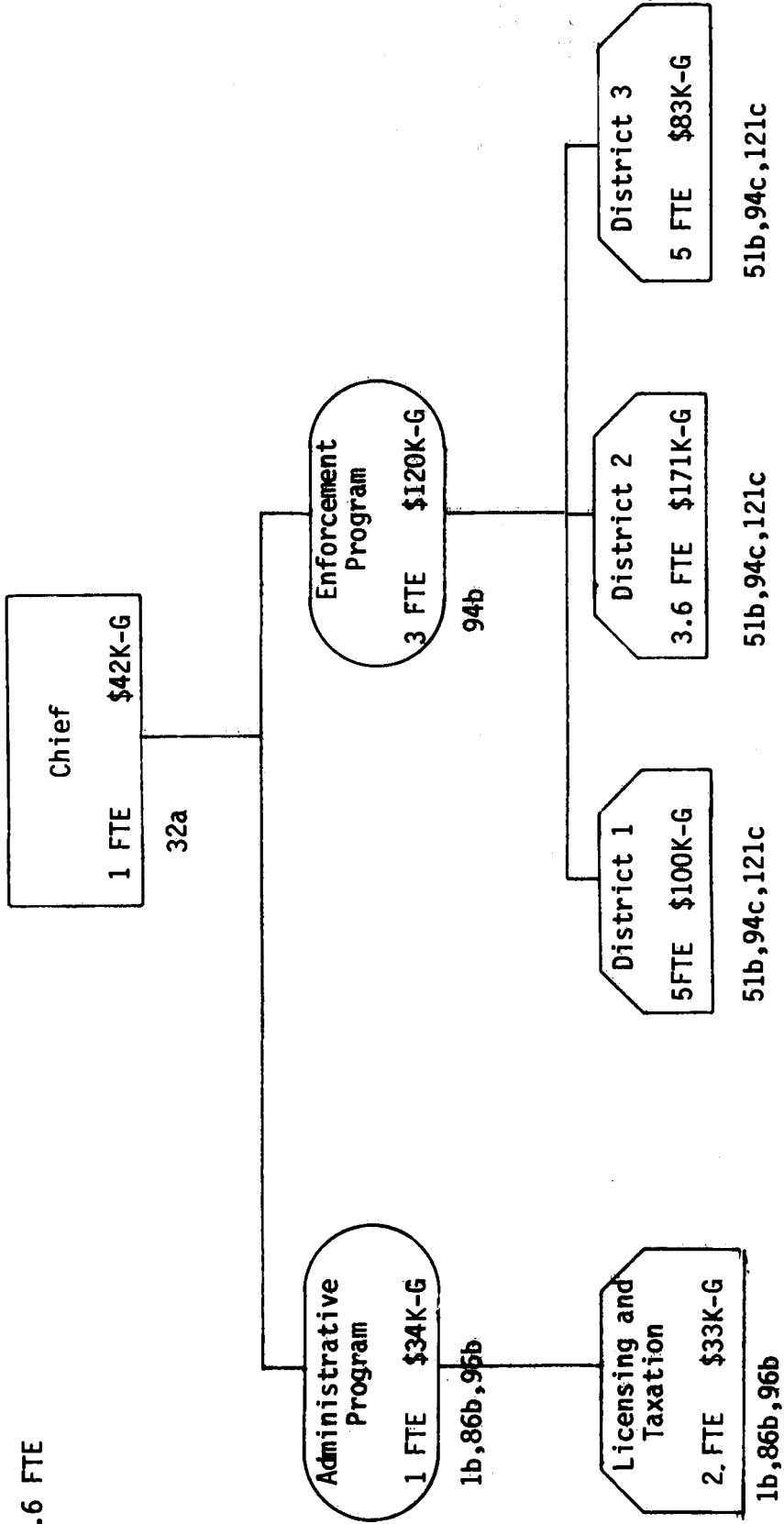

Division Totals:

\$2,848 K-HUTF
\$2,349 K-G

209.7 FTE

MANAGEMENT INFORMATION SERVICES DIVISION

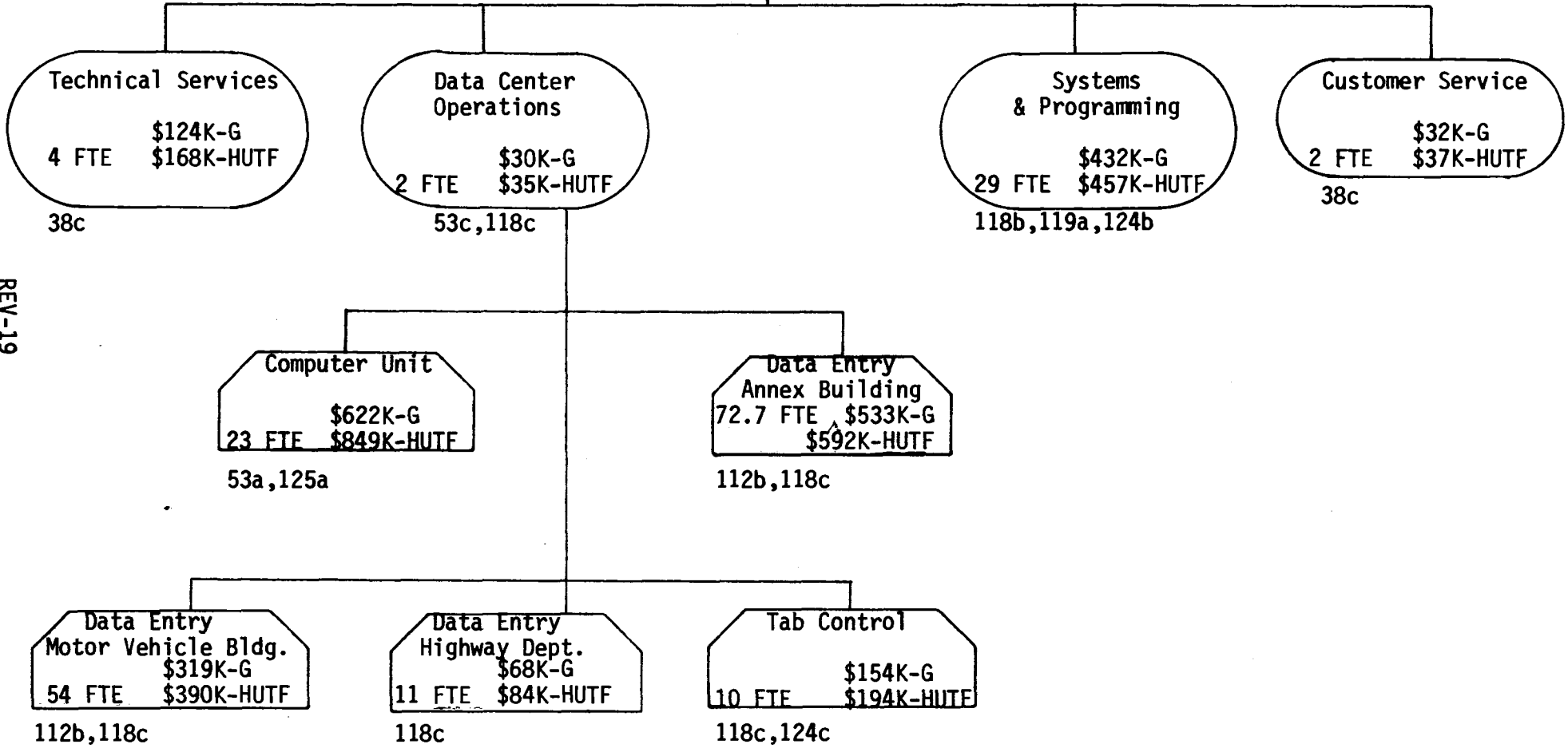
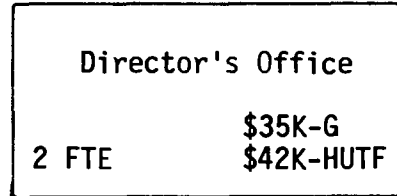

REV-19

Division Totals:

\$8,709 K-HUTF
 \$1,467 K-C
 \$45 K-G

490.6 FTE

MOTOR VEHICLE DIVISION

Director's Office

\$1K-G
 3 FTE \$315K-HUTF

Vehicle Services Assistant Director

\$47K-HUTF

1 FTE

26c, 28c, 55c, 130a

Driver Service Assistant Director

\$47K-HUTF

1 FTE

29c, 52c, 58c, 59c, 89c

REV-20

Titles

43 FTE \$603K-HUTF

7a, 84a

Registration

20 FTE \$383K-HUTF

10a, 15a, 55a, 81a, 82a, 83a, 100a

Emissions

27.9 FTE \$818K-C

9a, 25a, 26a, 72a, 74a

Dealer Licensing

20.7 FTE \$649K-C

4a, 5a, 28a, 30a, 71a, 73a

Drivers Licensing

\$17K-G
 224.5 FTE \$4,956K-HUTF

2a, 22a, 76a, 77a, 78a, 80a, 91a

Master Files

70.5 FTE \$1,007K-HUTF

18a, 52a, 61a, 65a, 123a

Driver Improvement

57 FTE \$810K-HUTF

3c, 17a, 62a, 89a

Enforcement Section

13 FTE \$320K-HUTF

29a

Building Services

\$27K-G
 9 FTE \$221K-HUTF

39a

Division Totals:

\$1,013 K-HUTF
\$3,380 K-G

184.8 FTE

OPERATIONS DIVISION

Chief
\$62K-G
3.0 FTE \$24K-HUTF

37a

Program Manager
\$35K-G
2.0 FTE \$14K-HUTF

37c,47c,113c,114c,115c

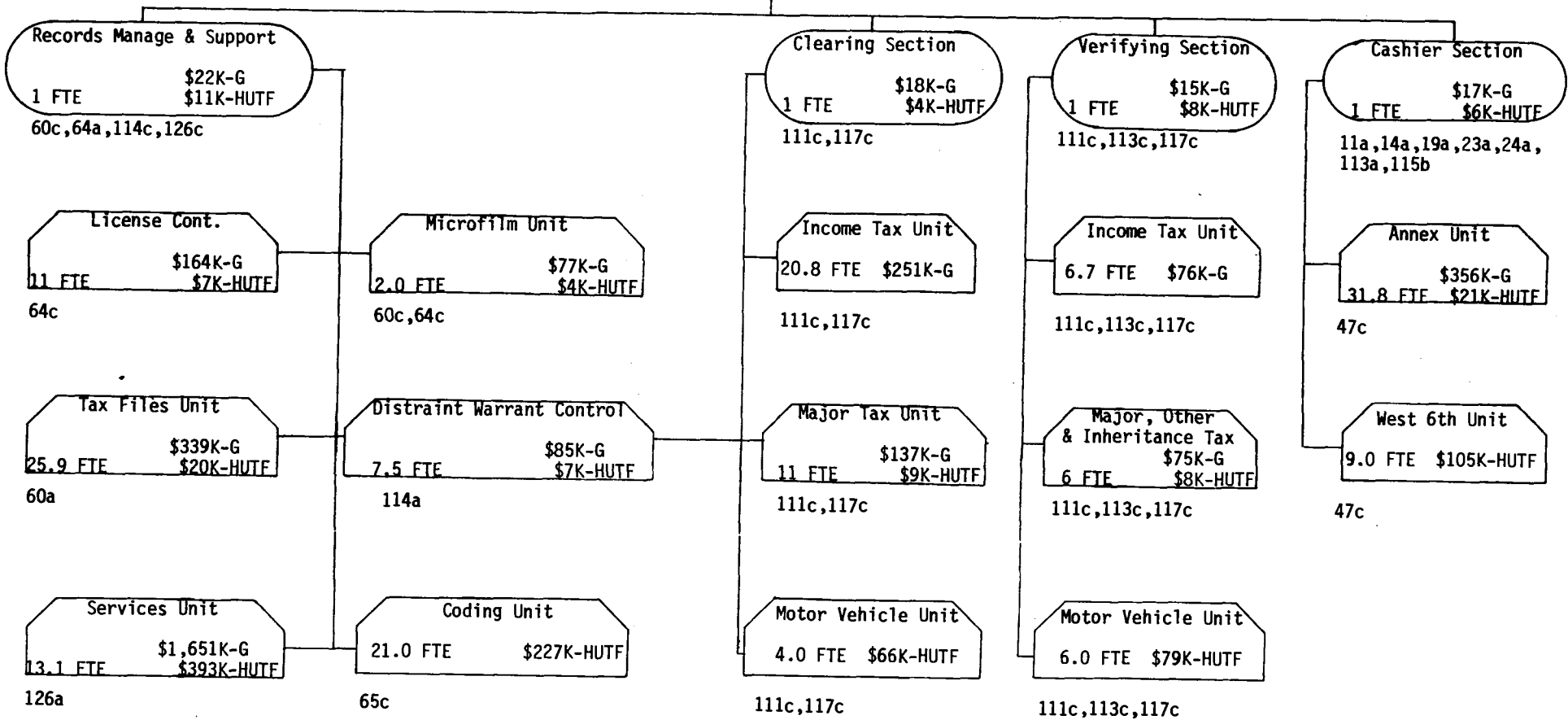

REV-21

Division Totals:

\$2,427 K-HUTF

77.5 FTE

PORT OF ENTRY DIVISION

REV-22

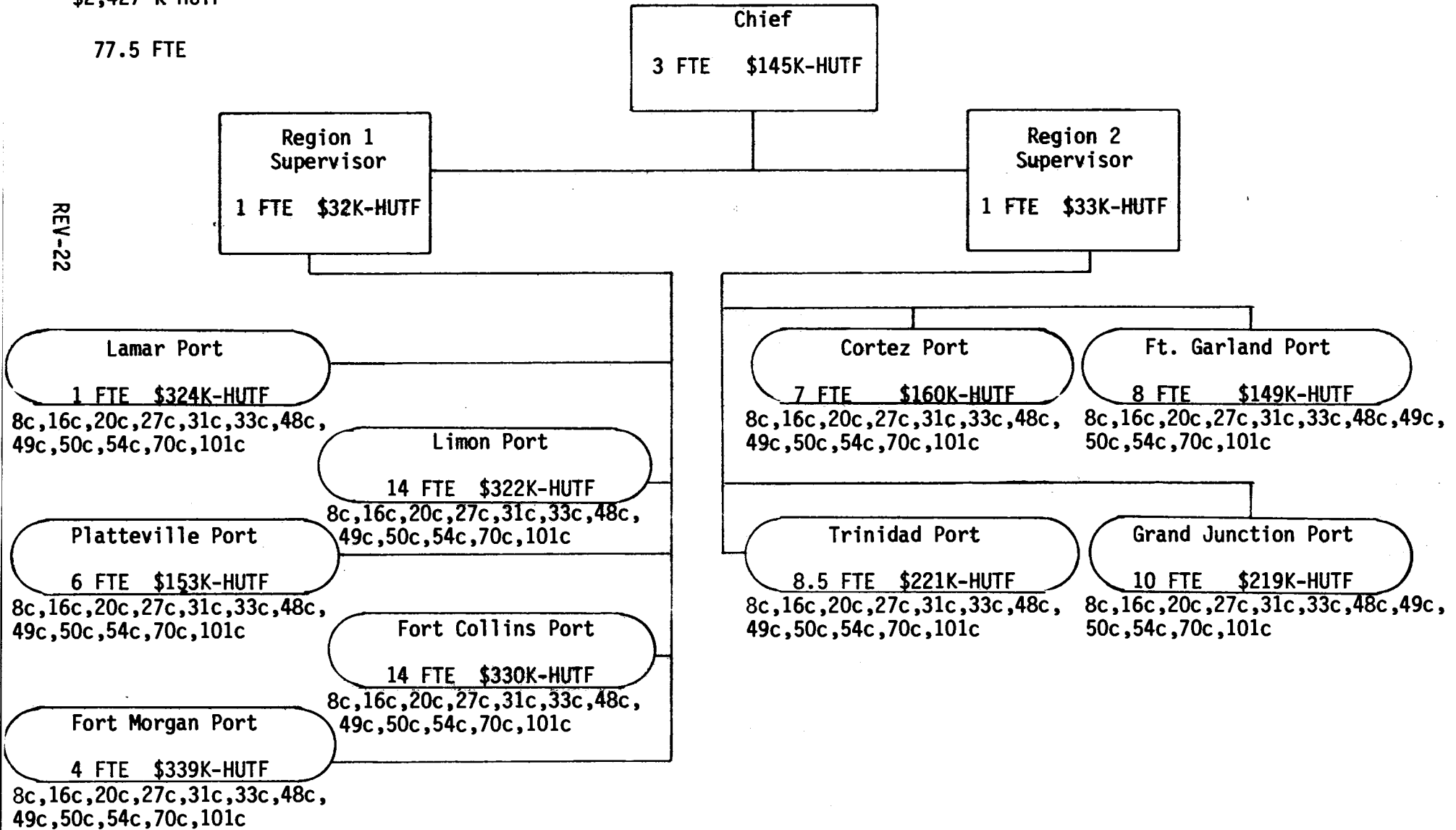

Division Totals:

\$4,798 K-G
\$301 K-HUTF

162 FTE

TAXATION DIVISION

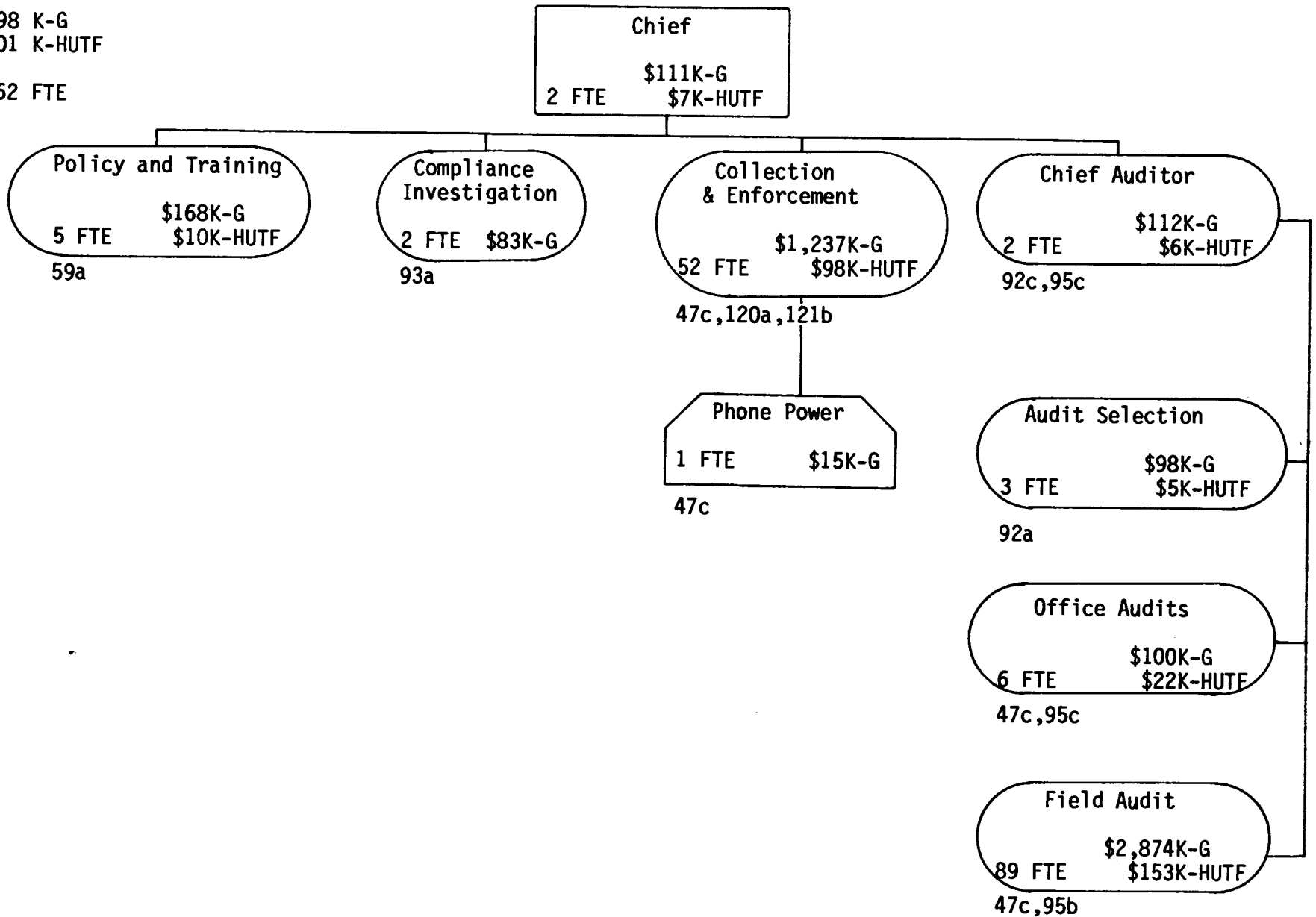

REV-23

Division Totals:

\$1,923 K-G
\$407 K-HUTF

112.5 FTE

TAXPAYER SERVICE DIVISION

Director's Office
\$77K-G
2 FTE \$20K-HUTF

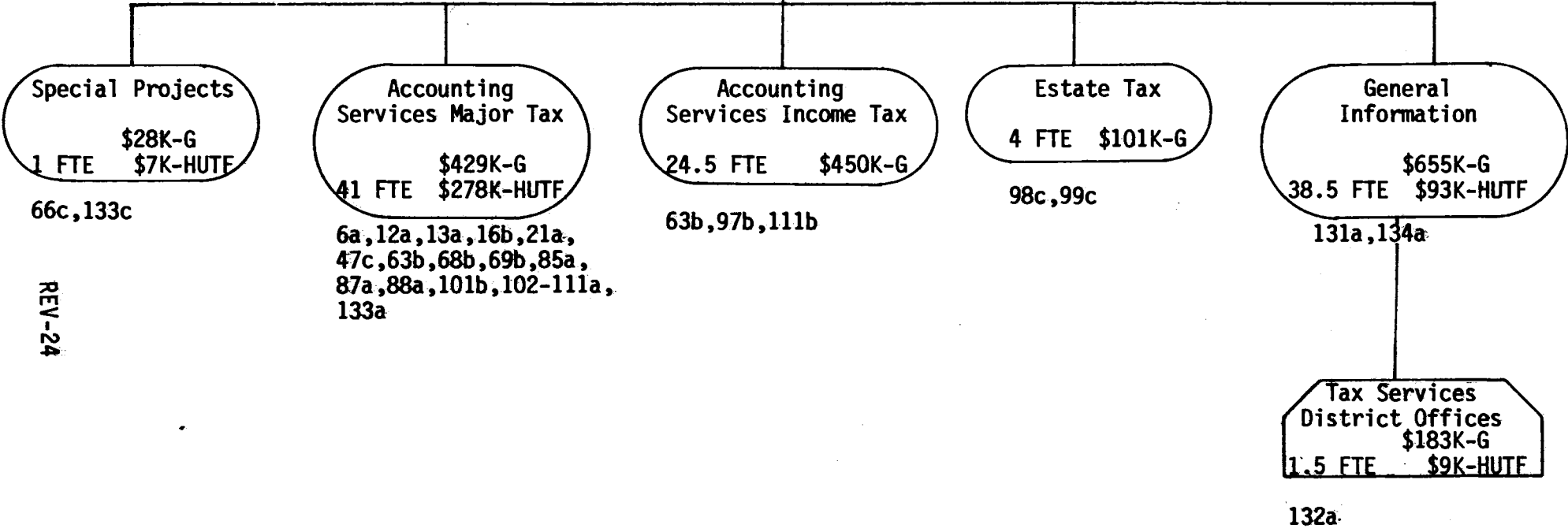

REV-24

DEPARTMENT OF SOCIAL SERVICES

Page

Administers a Vocational Rehabilitation Program

Blind.....	SS-1
Disability Determination.....	SS-1
Physically and Mentally Handicapped.....	SS-1
Workmen's Compensation.....	SS-2

Establishes Policy for and Administers a
Medical Assistance (Medicaid) Program

SS-2

Makes Policy for and Supervises the Administration
of Public Financial Assistance Programs

Aid to Families with Dependent Children (AFDC).....	SS-4
Work Incentive.....	SS-4
Assistance to the Aged, Blind or Disabled.....	SS-4
Food Assistance Programs.....	SS-5
Low Income Energy Cost Assistance.....	SS-5
Refugee Assistance.....	SS-6

Provides Interdepartmental Administration and Supervision

Administration.....	SS-6
Audits and Accounting.....	SS-8
Budgeting.....	SS-9
Intergovernmental Affairs.....	SS-10
Personnel.....	SS-10

Provides Veterans Affairs Service Programs

Nursing Homes.....	SS-11
--------------------	-------

Supervises Programs of Social Services
to Adults and Youths

Adults.....	SS-12
Aging.....	SS-13
Licensure of Childcare Facilities.....	SS-13
Youth.....	SS-13

DEPARTMENT OF SOCIAL SERVICES

Administers a Vocational Rehabilitation Program

Blind

1. Assures close cooperation between the rehabilitation center for the visually impaired and state agencies to ensure that products or services offered by the center are purchased. (Division of Rehabilitation, Deaf and Visually Impaired Section; 26-8.2-103, C.R.S. 1973)
2. Issues licenses to blind persons and trains them to operate vending facilities on state property. (Division of Rehabilitation, Business Enterprises Section; 26-8-105 and 26-8.5-102 and 104, C.R.S. 1973)
3. Works with elderly blind or visually impaired persons to assist them with personal adjustment skills. (Division of Rehabilitation, Rehabilitation Center Section; 26-8-103 (1) (c), C.R.S. 1973, and federal Vocational Rehabilitation Act)
4. Registers blind-made products and authorizes use of a departmental stamp of approval on the products. (Division of Rehabilitation, Business Enterprises Section; 26-8-105 and 26-8.8-103, C.R.S. 1973)
5. Works with elderly blind or visually impaired persons to assist with personal adjustment skills and other visually impaired persons who may become employable. (Division of Rehabilitation, Home Teaching Section; 26-8-103 and 105 (3) (f), C.R.S. 1973).

Disability Determination

6. Determines if Colorado residents are sufficiently medically disabled to qualify for federal social security disability insurance and federal supplemental security income programs. (Division of Rehabilitation, Disability Determination Services; 26-8-106, C.R.S. 1973, and federal Vocational Rehabilitation Act)

Physically and Mentally Handicapped

7. Manages, controls and supervises all rehabilitation programs mandated by law for the handicapped. (Division of Rehabilitation, Director's Office; 26-8-105 (1), C.R.S. 1973)

8. Places physically and mentally handicapped individuals into private employment. (Division of Rehabilitation, General Program Section; 26-8-105 (3) (h), C.R.S. 1973, and federal Vocational Rehabilitation Act)
9. Provides vocational and personal adjustment evaluation and training in order to assist individuals in achieving independence in day-to-day living, as well as in employment. (Division of Rehabilitation, Home Teaching Section; 26-8-105 (3) (g), C.R.S. 1973, and federal Vocational Rehabilitation Act)
10. Directs job placement and job readiness skills training to assist individuals. (Division of Rehabilitation, Special Programs Section; 26-8-105 (3) (e), C.R.S. 1973, and federal Vocational Rehabilitation Act)
11. Provides counseling, training, and job placement services to handicapped youth in the public secondary school system and to developmentally disabled individuals in sheltered workshops. (Division of Rehabilitation, Special Programs Section; 26-8-105 (3) (a) and (e), C.R.S. 1973)

Workmen's Compensation

12. Provides vocational rehabilitation services to injured workers referred by those insurance carriers who provide workmen's compensation coverage to employers. (Division of Rehabilitation, Workmen's Compensation Section; 8-49-101 (4), 26-8-105, C.R.S. 1973 and federal Vocational Rehabilitation Act)

Establishes Policy for and Administers a Medical Assistance (Medicaid) Program

13. Administers a state program of medical care services for the categorically needy in accordance with Title XIX of the federal Social Security Act. (Division of Medical Assistance, Director's Office; 26-4-104, C.R.S. 1973)
14. Prepares a comprehensive medical plan (and annual reevaluations) in accordance with federal requirements for the development of a medical care program. (Division of Medical Assistance, Director's Office; 26-4-106, C.R.S. 1973)
15. Adopts rules and regulations for the administration of payments to vendors for medical services to eligible recipients. (State Board of Social Services; 26-4-110, C.R.S. 1973)

16. Advises the state Department of Social Services on the provision of health and medical care services to recipients. (Division of Medical Assistance, Medical Assistance and Services Advisory Council; 26-4-113, C.R.S. 1973)
17. Establishes rules and regulations concerning the establishment of patient personal needs trust funds on the part of nursing care facilities or intermediate care facilities. (State Board of Social Services; 26-4-116, C.R.S. 1973)
18. Administers a program of Medicaid services including inpatient and outpatient hospital services. (Division of Medical Assistance, Hospital Services Section; 26-4-105 (1) (a) and (b), C.R.S. 1973, and Title XIX, Social Security Act)
19. Administers a program of home health care and, in addition, a program of skilled nursing and intermediate levels of care to Medicaid recipients in need of such care at only those health care facilities which are certified and licensed by the Colorado Department of Health. (Division of Medical Assistance, Long Term Care Section; 26-4-105 (1) (e), (f), and (h), C.R.S. 1973)
20. Administers a program of Medicaid services including laboratory and x-ray services, physician's services, prescribed drugs, transportation, eyeglasses after surgery, early periodic screening and diagnosis of treatment, family planning, clinic services, rural health clinic services, and medical or remedial care by podiatrists. (Division of Medical Assistance, Pharmacy and Ambulatory Care Section, 26-4-105 (1) (c), (d), (g), (i), (j), (k), (l), (m), (n) and (o), C.R.S. 1973)
21. Administers a program (carried out by county departments of social services or others designated by county commissioners) of alternative services to long term nursing care including home health services, personal care services, respite care services, transportation, environmental services, and case management services. (Division of Aging and Adult Services, Program Services Section; 26-4.5-104.5, C.R.S. 1973)
22. Provides a system of reimbursement for alternative services to long term nursing care. (Division of Medical Assistance, Long Term Care Section; 26-4.5-105, C.R.S. 1973)

23. Administers programs of early and periodic screening, and diagnosis and treatment services for categorically needy Medicaid-eligible individuals under age 21. (Division of Medical Assistance, Pharmacy and Ambulatory Care Section; 26-4-105 (1) (k), C.R.S. 1973)

Makes Policy for and Supervises the Administration
of Public Financial Assistance Programs

Aid to Families with Dependent Children (AFDC)

24. Provides a program, carried out by county departments of social services, of financial aid for needy children who are deprived of parental support because of absence, incapacity, death, or unemployment of one or both parents. (Division of Income and Support Services, Income Maintenance Section; 26-2-111 (3), C.R.S. 1973, and Title IVA, Social Security Act)
25. Administers a parent locator service to assist local social service agencies in finding parents who have abandoned their children. (Division of Income and Support Services, Child Support Enforcement Section; 26-13-107, C.R.S. 1973, and Title IVD, Social Security Act)
26. Establishes and enforces a program that provides child support enforcement services in accordance with Title IVD of the federal Social Security Act. (Division of Income and Support Services, Child Support Enforcement Section; 26-13-103, C.R.S. 1973, and the Social Security Act)

Work Incentive

27. Provides a program carried out by county departments of social services in cooperation with the state Department of Labor and Employment to secure the job placement of parents receiving aid to families with dependent children. (Division of Income and Support Services, Income Maintenance Section; 26-1-109 (2), 26-2-111 (3) (c), C.R.S. 1973, and Title IVC, Social Security Act)

Assistance to the Aged, Blind, or Disabled

28. Provides old age pension public assistance administered by county departments of social services. (Division of Income and Support Services, Income Maintenance Section; 26-2-104 and 111 (2), C.R.S. 1973)

29. Provides financial assistance (administered by county departments of social services) to eligible legally blind individuals with little or no income and resources. (Division of Income and Support Services, Income Maintenance Section; 26-2-104 and 111 (5), C.R.S. 1973)
30. Provides financial assistance (administered by county departments of social services) to eligible disabled individuals with little or no income and resources. (Division of Income and Support Services, Income Maintenance Section; 26-2-111 (4), C.R.S. 1973)
31. Provides, through county departments of social services, supplementation of federal supplemental security income benefits to qualified disabled and blind individuals. (Division of Income and Support Services, Income Maintenance Section; 26-2-204, C.R.S. 1973)

Food Assistance Programs

32. Makes policy for, and administers and supervises the implementation by county social service departments of, the federal food stamp program. (Division of Income and Support Services, Food Assistance Section; 26-2-301, C.R.S. 1973, and the Federal Food Stamp Act)
33. Accepts and distributes food donated to Colorado by the U.S. Department of Agriculture for distribution to public and private nonprofit schools for children of high school grade and under, residential and non-residential child care centers, nutrition programs for the elderly, summer camps that are nonprofit and conducted for children of high school grade and under, institutions serving needy adults, adult correctional institutions, and supplemental feeding programs serving pregnant and nursing mothers and children up to six years of age. (Division of Income and Support Services, Food Assistance Section; 26-1-109 (2) (a), C.R.S. 1973)

Low Income Energy Cost Assistance

34. Provides a program of financial assistance carried out by county departments of social services to pay utility bills for low income individuals or families. (Division of Income and Support Services, Low Income Energy Assistance Section; 26-1-109 (2) (a), C.R.S. 1973, and P.L. 97-35)

Refugee Assistance

35. Makes policy for, and administers and supervises the implementation by, county departments of financial and medical assistance, language training, work orientation, and self-sufficiency services to eligible refugees. (Division of Income and Support Services, Refugee Services Section; 26-1-109 (2), C.R.S. 1973, and P.L. 96-212 Refugee Act of 1980)

Provides Intradepartmental Administration and Supervision

Administration

36. Establishes policy for appeals from applicants for medical benefits when a county department of social services has acted in an adverse manner. (Office of Executive Director; 26-4-109, C.R.S. 1973)
37. Establishes policy which provides for appeals and hearings in reference to rights of clients, recipients and vendors participating in programs administered by the department. (State Board of Social Services; 26-1-106, C.R.S. 1973)
38. Assists all departmental organizational units through the provision of technical assistance (accounting, field audits, personnel management and quality control) in all administrative areas. (Office of Associate Director for Administration; no state statutory mandate)
39. Promulgates rules governing matters of internal administration (including fiscal and personnel administration and disbursement of federal funds) in the state and county departments of social services. (Office of Executive Director; 26-1-108 (1) (a), C.R.S. 1973)
40. Provides services to county governments in the administration of the social service program components performed by county departments of social services and area agencies on aging including a monitoring program for compliance and corrective actions. (Associate Director for Operations, Management Review Unit; 26-1-111 (2) (d), C.R.S. 1973)
41. Assures that all departmental rules are enacted in accordance with the provisions of the state's administrative procedures act; completes the official transcripts and minutes of meetings; transmits all adopted rules to county departments and district offices; forwards all state plans and amendments to the federal regional office; and stores all departmental rules and regulations. (Office of Intergovernmental Affairs, Office of the State Board Secretariat; 26-1-105, C.R.S. 1973)

42. Promulgates rules and regulations for the scope and content of all programs of the department. (State Board of Social Services; 26-1-108 (1) (b), C.R.S. 1973)
43. Reviews medical assistance (Medicaid) claims and files and conducts claims processing procedures in addition to coordinating all changes to reimbursement claims processing due to changes in regulations or practice. (Division of Medical Assistance, Fiscal Agent Monitoring Section; 26-1-105, C.R.S. 1973)
44. Reviews claims made by Medicaid providers and services rendered to recipients to determine potential misuse of services, excessive claims, misrepresentation, or fraud and investigates questionable providers and recipients. (Division of Medical Assistance, Surveillance and Review; 26-4-112, C.R.S. 1973)
45. Determines liability of third parties for payment of medical services rendered and obtains such payments. (Division of Medical Assistance, Appeals and Recovery Section; 26-4-115, C.R.S. 1973)
46. Investigates possible criminal acts by providers of services purchased through the department and refers cases to local district attorneys or the state attorney general for prosecution. (Office of Executive Director, Office of Investigations; 26-1-105, C.R.S. 1973)
47. Audits and investigates nursing home personal needs funds and requires repayment of misspent funds to the state or patients. (Office of Executive Director, Office of Investigations; 26-1-105, C.R.S. 1973)
48. Reviews nursing home vendors audits, resolves audit issues and the settlement, collection, and disbursement of funds collected from nursing homes and other medical providers, and reviews nursing home patient trust fund bank statements. (Associate Director for Administration, Field Audits and Quality Assurance Section, Field Audits Unit; 26-1-105, C.R.S. 1973)
49. Audits county departments of social services and area agencies on aging to determine if funds are expended according to rules and regulations of the state Department of Social Services and acceptable accounting procedures. (Associate Director for Administration, Field Audits and Quality Assurance Section, Field Audits Unit; 26-1-105, C.R.S. 1973)

50. Develops corrective actions designed to deter program abuse by vendors. (Office of Executive Director, Office of Investigations and Division of Medical Assistance, Surveillance and Review Section; 26-1-105 and 26-4-112, C.R.S. 1973)
51. Supervises office systems development, staff development, client outcome monitoring, and internal management review. (Associate Director for Operations, Management Services Section; 26-1-105, C.R.S. 1973)
52. Implements client outcome monitoring as the basic procedure for evaluating service programs administered by the county departments. (Associate Director for Operations, Management Services Section, Outcome Monitoring Unit; 26-1-105, C.R.S. 1973)
53. Ensures that eligible individuals and families receive services and assistance through service delivery systems in county departments of social services and area agencies on aging. (Associate Director for Operations, Field Administration Section; 26-1-111 (2) (d), C.R.S. 1973, and Title 26, Article I of the Social Services Code, and the federal Older Americans Act of 1965)
54. Provides ADP assistance to the program and support divisions of the department, various county departments, other state agencies, and the federal government; maintains and manages data applicable to all clientele groups for application, eligibility approval, fund distribution, case monitoring, and closure stages; and maintains data links with the county departments and vocational rehabilitation offices. (Associate Director for Operations, Information Systems Section; no state statutory mandate)
55. Oversees, monitors, and administratively directs ongoing program responsibilities in all client-service divisions. (Office of Associate Director for Programs; 26-1-105, C.R.S. 1973)
56. Implements new program initiatives. (Office of Associate Director for Programs; 26-1-105, C.R.S. 1973)

Audits and Accounting

57. Operates an AFDC food stamp and Medicare quality control error rate program. (Associate Director for Administration, Field Audits and Quality Assurance Section; 26-1-105, C.R.S. 1973)

58. Sets rates for residential child care facilities and child placement agencies. (Associate Director for Operations, Management Services Section, Planning Unit; 26-6-105, C.R.S. 1973)
59. Provides policy direction to divisions for all new program initiative studies. (Office of Associate Director for Programs; 26-1-105, C.R.S. 1973)
60. Maintains linkages between program directors and the department's executive director. (Office of Associate Director for Programs; 26-1-105, C.R.S. 1973)
61. Prepares federal fiscal reports; processes payments to grantee agencies; ensures proper authorizations and billings and payments to or on behalf of vocational rehabilitation clients; processes payments for all departmental operations; processes payments to providers of medical benefits; prepares departmental financial statements and management reports; interfaces departmental accounting records for the rehabilitation center for the visually impaired and the business enterprise program; determines the accuracy of expenditure data submitted by county departments; and prepares and adjusts advance funding. (Associate Director for Administration, Accounting Office; 26-1-105, C.R.S. 1973)
62. Serves as central control on all audits and proposed sanctions against counties. (Office of Associate Director for Operations; 26-1-105, C.R.S. 1973)

Budgeting

63. Enforces rules and regulations for the administration of each county's social services fund and reviews each county social services budget. (Associate Director for Operations, Management Services Section; 26-1-123 and 124, C.R.S. 1973)
64. Adopts budgetary standards from which a graduated schedule of fees is determined for use by those persons receiving social services and who have the financial ability to pay. (State Board of Social Services; 26-2-122 (3), C.R.S. 1973)
65. Assumes responsibility for the overall departmental budgeting policies and procedures including the preparation, justification and implementation of the department's budget. (Executive Director's Office, Office of the Budget; 26-1-105, C.R.S. 1973)

Intergovernmental Affairs

66. Manages the substantive legislative issues affecting the department; controls the contractual relationship between the department and the Department of Law; analyzes and disseminates proposals before Congress and other directives from the federal government; and supervises the rule-making and contract management functions of the department. (Office of Associate Director for Intergovernmental Affairs; 26-1-105, C.R.S. 1973)
67. Provides a point of contact between the state department and county departments of social services; develops and implements processes to monitor and evaluate the delivery of services; develops and implements improved management systems in counties; and provides counties specific assistance and training as necessary to increase the efficiency and effectiveness of county operations. (Office of Associate Director for Intergovernmental Affairs; 26-1-111 (2) (d), C.R.S. 1973)
68. Serves as staff to county policy advisory committees which provide the counties' perspective and input to departmental policy development. (Office of Associate Director for Intergovernmental Affairs; 26-1-111 (2) (d), C.R.S. 1973)
69. Develops and maintains working relationships between program divisions and local agencies and coordinates departmental efforts with other state agencies. (Office of Associate Director for Intergovernmental Affairs; 26-1-105, C.R.S. 1973)
70. Directs or coordinates projects and programs which are interdepartmental or interdivisional in scope including studies mandated by the general assembly and also assists the associate director in establishing division goals, objectives, and organization. (Office of Associate Director for Programs; 26-1-105, C.R.S. 1973)

Personnel

71. Fixes minimum standards and qualifications and establishes salary schedules for county departments of social services personnel. (State Board of Social Services; 26-1-108 (2), C.R.S. 1973)
72. Maintains a merit system for the selection, retention, and promotion of employees of the several county departments of social services. (Associate Director for Operations, Merit System Section; 26-1-120, C.R.S. 1973)
73. Acts as the personnel office manager for the department. (Office of Associate Director for Administration, Personnel Section; 26-1-105, C.R.S. 1973)

74. Allocates funds and personnel positions to county departments. (Associate Director for Operations, Management Services Section; 26-1-105, C.R.S. 1973)
75. Provides or coordinates training activities for county social services staff. (Associate Director for Operations, Management Services Section, Staff Development Unit; 26-1-105, C.R.S. 1973)
76. Provides or coordinates training for state department staff. (Associate Director for Operations, Management Services Section, Staff Development Unit; 26-1-105, C.R.S. 1973)

Provides Veterans Affairs Services Programs

77. Establishes standard procedures for the provision of services to all veterans in the state. (Division of Veterans Affairs, Veterans Services Section; 26-9-104, C.R.S. 1973)
78. Studies the problems of veterans and may propose programs of state assistance to veterans by the department of social services. (Board of Veterans Affairs; 26-10-104, C.R.S. 1973)
79. Administers programs of services to veterans and surviving family members and assistance to county veterans' service officers. (Division of Veterans Affairs, Director's Office; 26-10-106 and 108, C.R.S. 1973)
80. Acts as an advocate for veterans in appeals to the federal Veterans Service Administration for a review of benefits. (Division of Veterans Affairs, Director's Office; 26-10-106 (1) (b), C.R.S. 1973)
81. Assists veterans and their survivors or dependents in applying for and appealing veterans' pensions and other awards. (Division of Veterans Affairs, Director's Office; 26-10-108, C.R.S. 1973)

Nursing Homes

82. Adopts policies, rules and regulations for the management, control and supervision of state nursing homes. (State Board of Social Services; 26-12-102, C.R.S. 1973)
83. Establishes standards for admission to any state nursing home. (State Board of Social Services; 26-12-104, C.R.S. 1973)

84. Establishes rates for the care of patients in state nursing homes. (Office of Executive Director; 26-12-106, C.R.S. 1973)
85. Adopts all policies, rules, and regulations for the utilization, management, control, and supervision of the Colorado State Veterans Center. (State Board of Social Services; 26-12-302, C.R.S. 1973)
86. Oversees the state nursing homes for veterans. (Division of Veterans Affairs, Director's Office; 26-12-401, C.R.S. 1973)
87. Assists aged residents at the Trinidad State Nursing Home through 24-hour skilled and intermediate nursing home care. (Division of Veterans Affairs, Trinidad State Nursing Home; 26-12-201, C.R.S. 1973)
88. Enables the Colorado State Veterans Center veterans and non-veterans to be cared for through intermediate nursing care. (Division of Veterans Affairs, Colorado State Veterans Center; 26-12-301 through 311, C.R.S. 1973)
89. Provides intermediate nursing home care to veterans and non-members at the Colorado State Veterans Nursing Home at Florence. (Division of Veterans Affairs, Colorado State Veterans Nursing Home; 26-12-401, C.R.S. 1973)

Supervises Programs of Social Services to Adults and Youths

Adults

90. Provides for a program, performed by county departments of social services, concerning adult foster care and the certification of adult foster care facilities by county departments of social services. (Division of Aging and Adult Services, Director's Office; 26-1-111 (2) (j) and 26-2-114 (2) (a), C.R.S. 1973, and Title XX, Social Security Act)
91. Provides a program performed by county departments of social services with, or on behalf of, incapacitated adults to correct or alleviate situations in which actual or imminent danger of abuse, neglect or exploitation exists and utilizes support systems to provide continuing safety from incidents. (Division of Aging and Adult Services and State Board of Social Services, Director's Office; 26-2-122, C.R.S. 1973, and Title XX, Social Security Act)
92. Maintains or improves the level of social, psychological and economic functioning of aged or disabled persons to enable them to remain in the community, preventing institutionalization and/or deterioration of functioning

ability. (Division of Aging and Adult Services, Program Services Section; 26-2-122 and 26-1-111 (2) (j), C.R.S. 1973)

Aging

93. Provides a program of social services, funded under the federal Older Americans Act, to provide the elderly with access to the community, including transportation and outreach, and homemaker and home health aid. (Division of Aging and Adult Services, Director's Office; 26-1-109 and 26-11-105 (1) (c), C.R.S. 1973, and Title IIIB, Older Americans Act)
94. Promotes nutrition through the provision of meals and on-site education regarding the importance of maintaining adequate nutrition. (Division of Aging and Adult Services, Program Services Section; 26-1-109 and 26-11-101, C.R.S. 1973, and Older Americans Act)
95. Provides an advocacy assistance program mandated by the federal law to handle nursing home complaints and deliver legal services to older persons. (Division of Aging and Adult Services, Program Services Section; 26-1-109 and 26-11-101, C.R.S. 1973, and Title IIIB, Older Americans Act)
96. Promotes and aids the establishment of programs and services for the aging and aged. (Colorado Commission on the Aging; 26-11-105, C.R.S. 1973)

Licensure of Child Care Facilities

97. Inspects, licenses, and enforces minimum standards for family care homes and child care centers for both day care and 24-hour care with some of the activities carried out by the counties. (Division of Family and Children's Services, Child Care Licensing Section; 26-6-104, C.R.S. 1973)
98. Advises and consults with the department in the administration and enforcement of the law regarding the licensure of child care facilities. (Division of Family and Children's Services, Advisory Commission on Licensing of Child Care Facilities; 26-6-109, C.R.S. 1973)

Youth

99. Administers a statewide adoption resource registry to serve authorized or licensed child placement agencies. (Division of Family and Children's Services, Family and Children's Services Section; 26-1-111 (4), C.R.S. 1973)

100. Provides a program, performed by county departments of social services, to extend the following services to delinquents, status offenders, dependent or neglected children: foster care, alternatives to foster care, court-ordered services, and services to youth in severe conflict with parents. (Division of Family and Children's Services, Family and Children's Services Section; 26-2-122, C.R.S. 1973)
101. Provides a program, performed by county departments of social services, to extend the following services: investigation of abuse and neglect reports, services to children abused, neglected or at risk of abuse, and services as ordered by the court. (Division of Family and Children's Services, Family and Children's Services Section; 26-2-122, C.R.S. 1973)
102. Provides a program, implemented by county departments of social services, to extend the following services: making payments to adoptive parents, assisting children in foster care situations, relinquishment counseling, court-ordered custody investigations, and services to developmentally disabled children in foster care. (Division of Family and Children's Services, Family and Children's Services Section; 26-7-102 and 26-1-111 (4), C.R.S. 1973)
103. Provides a program, performed by county departments of social services, to extend the following services: adoptive home recruitment activities and child and adult foster care recruitment, supervision, certification and licensing. (Division of Family and Children's Services, Family and Children's Services Section; 26-7-102, C.R.S. 1973)
104. Maintains the Colorado child abuse registry. (Division of Family and Children's Services, Family and Children's Services Section; 19-10-114, C.R.S. 1973)
105. Administers the Interstate Compact on the Placement of Children for the placement of children in Colorado. (Division of Family and Children's Services, Family and Children's Services Section; 24-60-1801 and 26-1-111 (2) (k), C.R.S. 1973)

Department Totals:

\$9,820 K-G
 \$11,929 K-F
 \$2,673 K-C
 \$4,467 K*
 1,032.7 FTE

DEPARTMENT OF SOCIAL SERVICES

SS-15

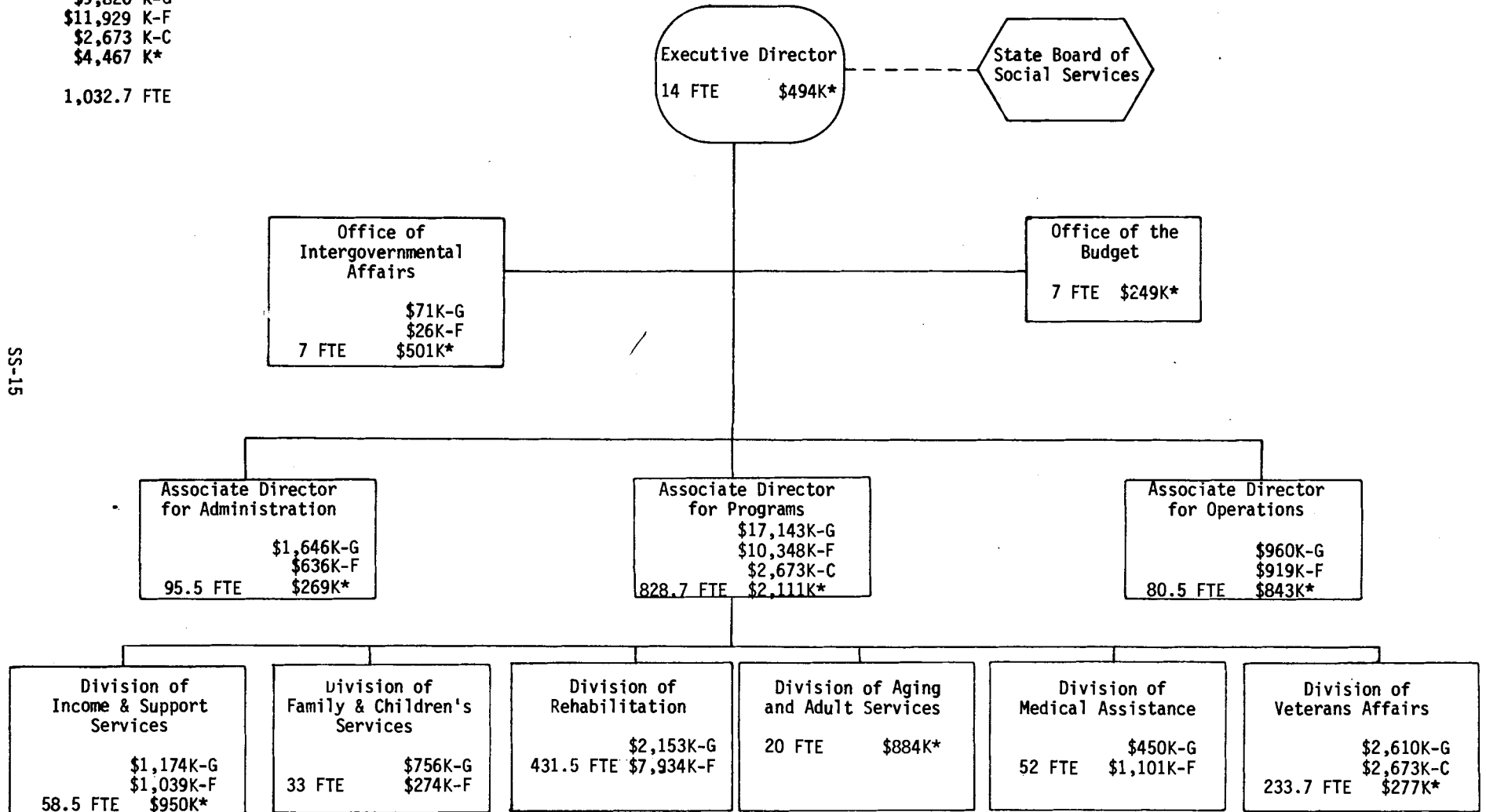

* Funding sources not available.

Office Totals:

\$494 K*

14 FTE

OFFICE OF EXECUTIVE DIRECTOR

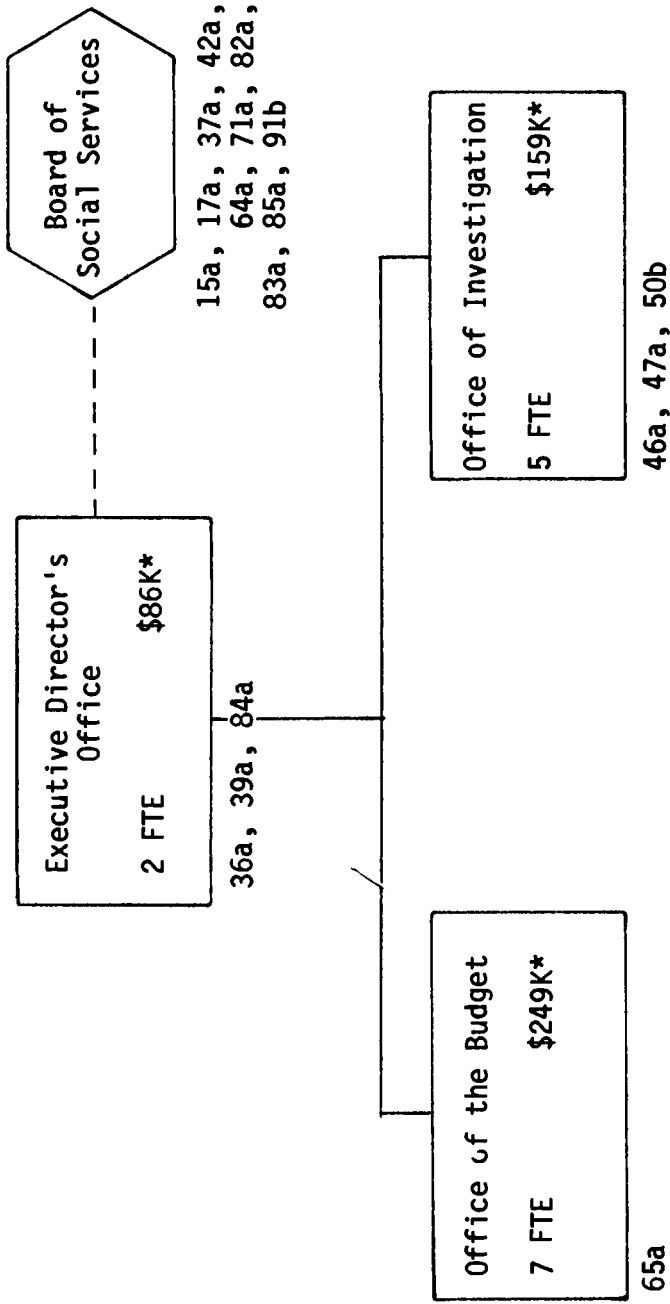

* Funding sources not available.

ADMINISTRATION

Area Totals:

\$1,646 K-G
 \$636 K-F
 \$269 K*

95.5 FTE

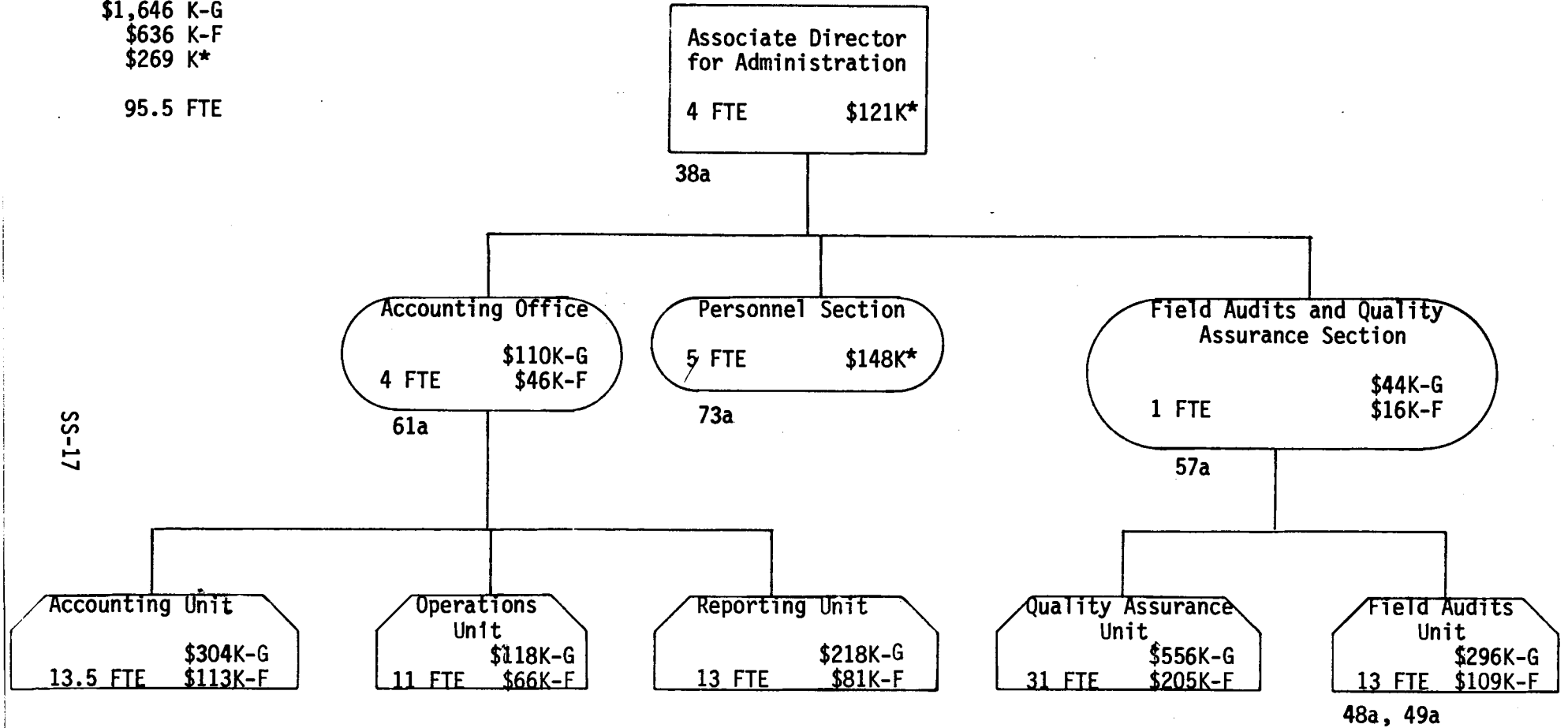

SS-17

* Funding sources not available.

DIVISION OF AGING AND ADULT SERVICES

Division Totals:

\$884 K*

20 FTE

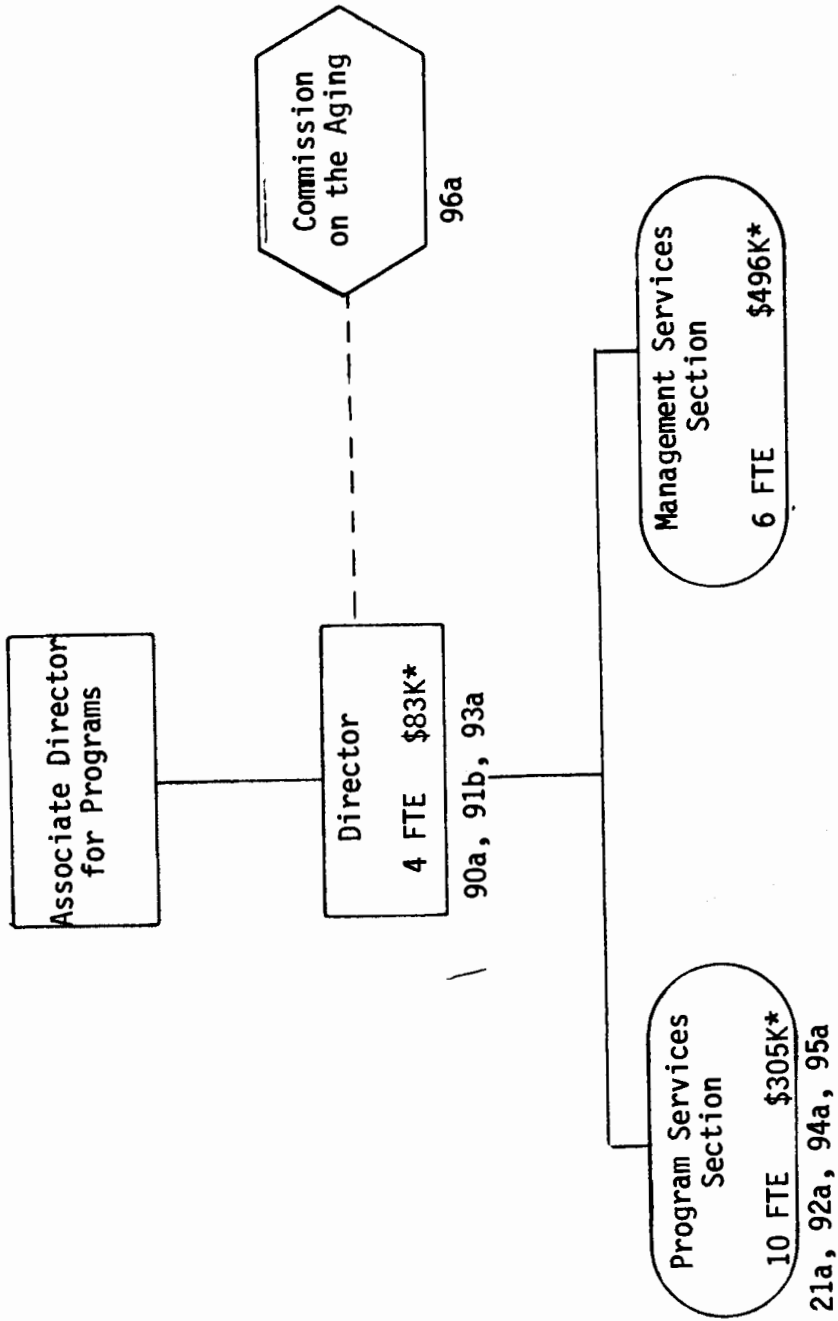

* Funding sources not available.

Division Totals:

\$756 K-G
\$274 K-F

33 FTE

DIVISION OF FAMILY AND CHILDREN'S SERVICES

SS-19

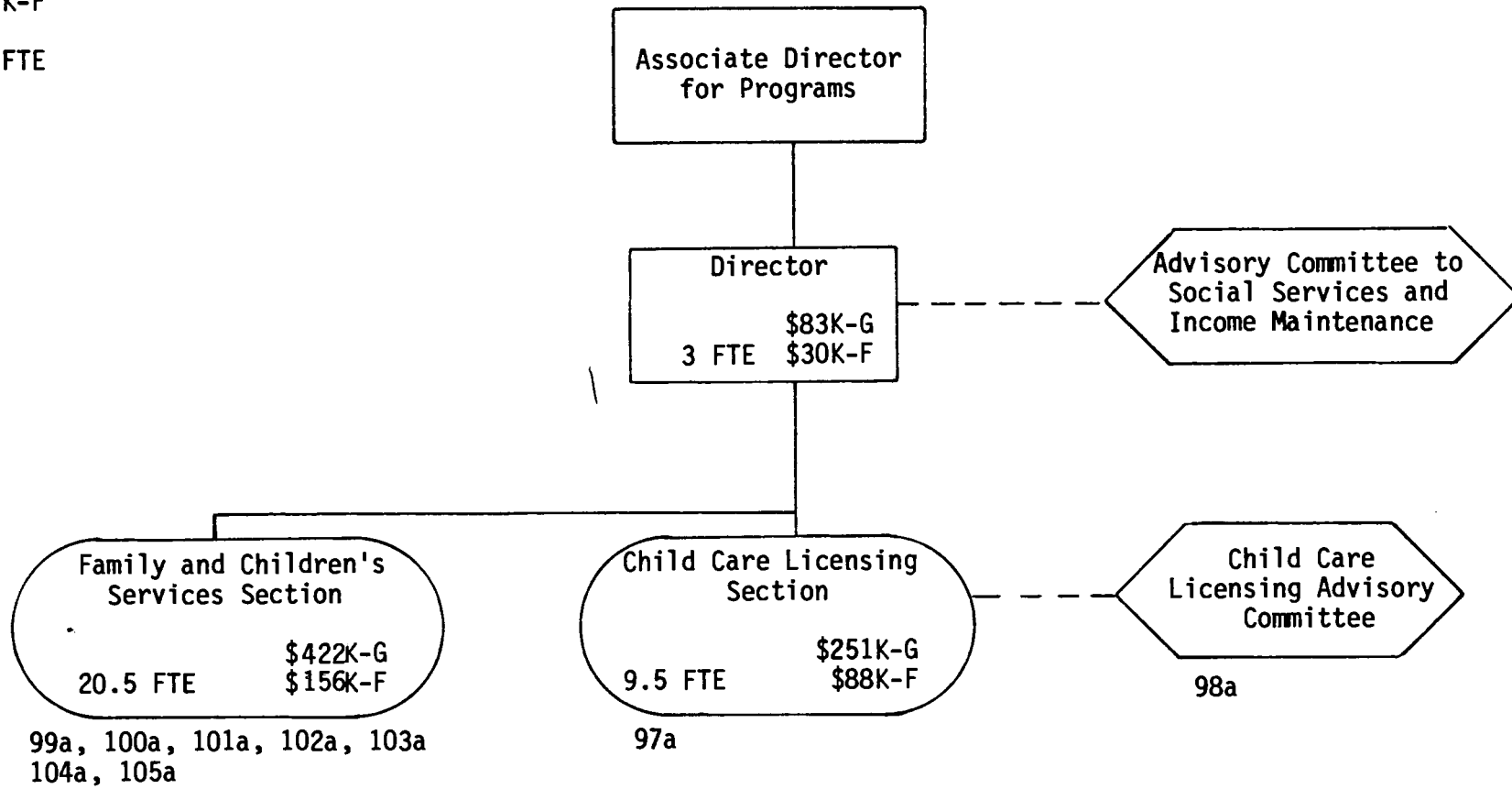

OFFICE OF INTERGOVERNMENTAL AFFAIRS

Area Totals:

\$71 K-G
 \$26 K-F
 \$501 K*
 7 FTE

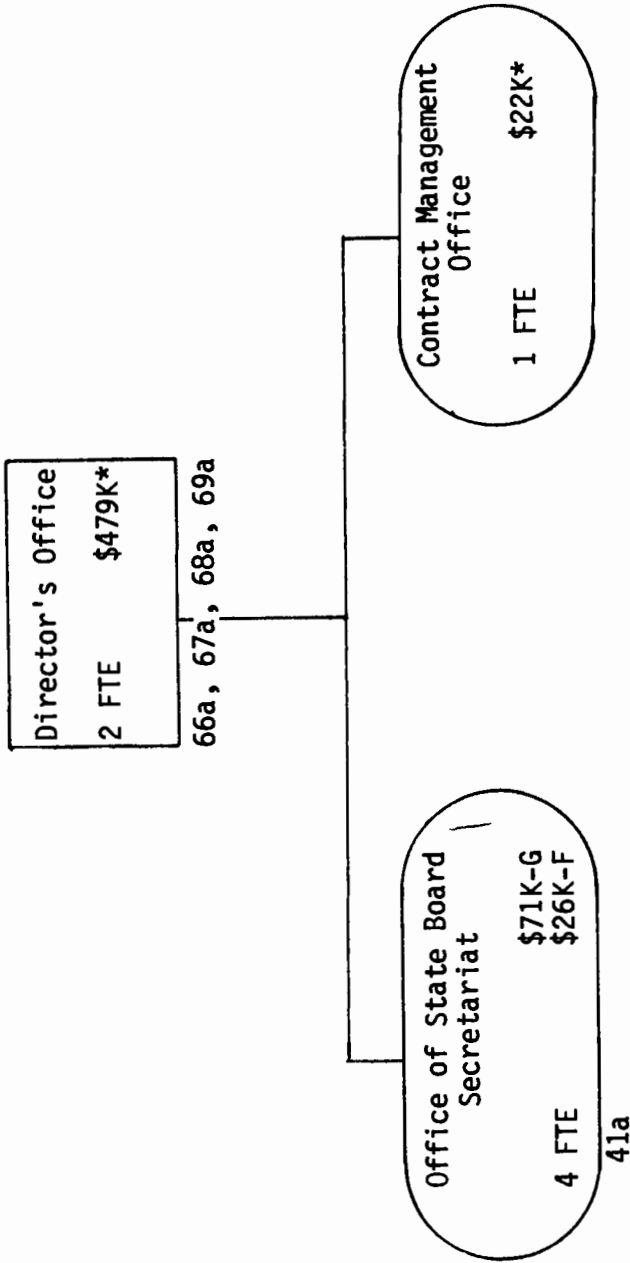

* Funding sources not available.

DIVISION OF INCOME AND SUPPORT SERVICES

Division Totals:

\$1,174 K-G
 \$1,039 K-F
 \$950 K*

58.5 FTE

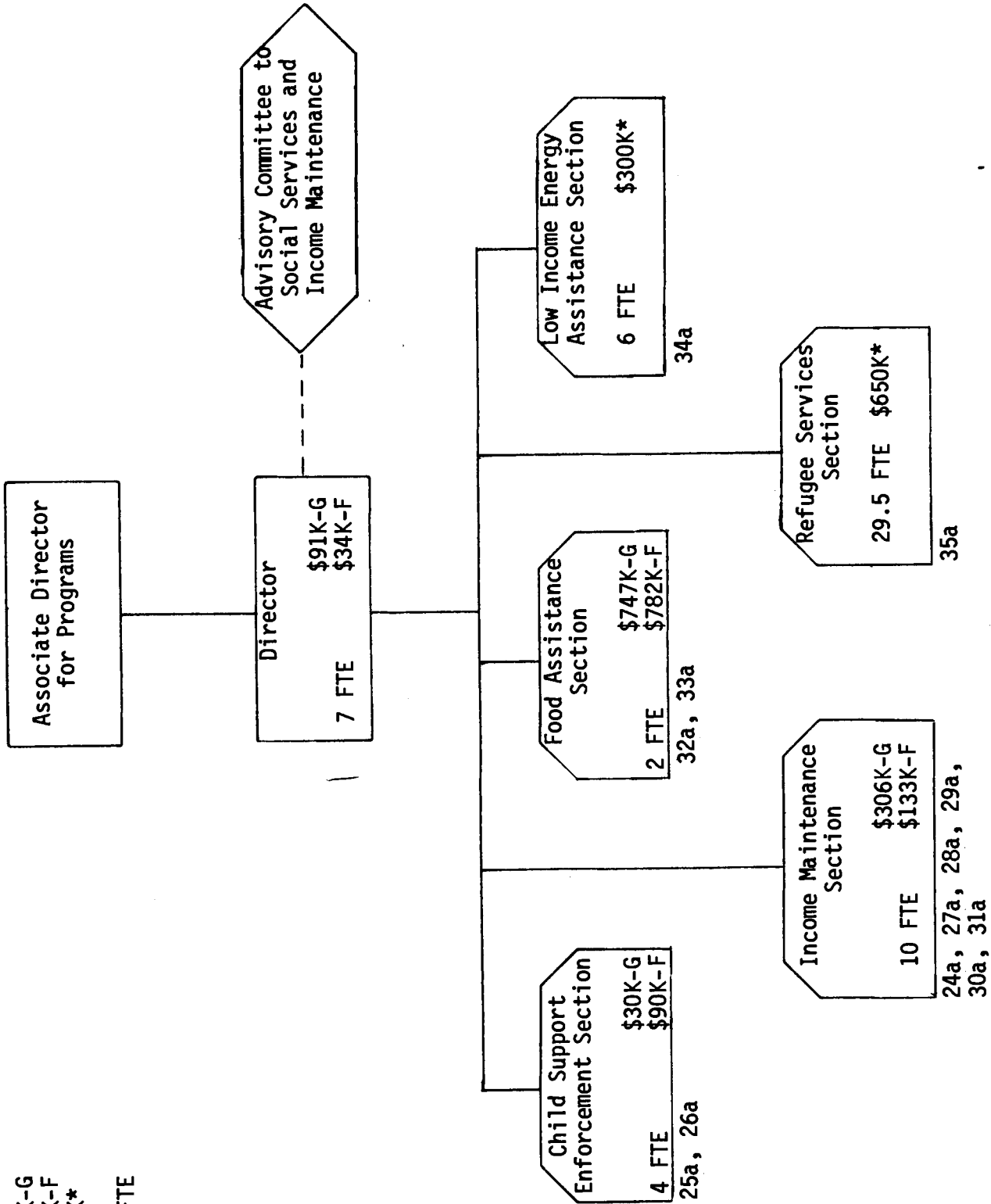

* Funding sources not available.

DIVISION OF MEDICAL ASSISTANCE

Division Totals:

\$450 K-G
\$1,101 K-F

52 FTE

SS-22

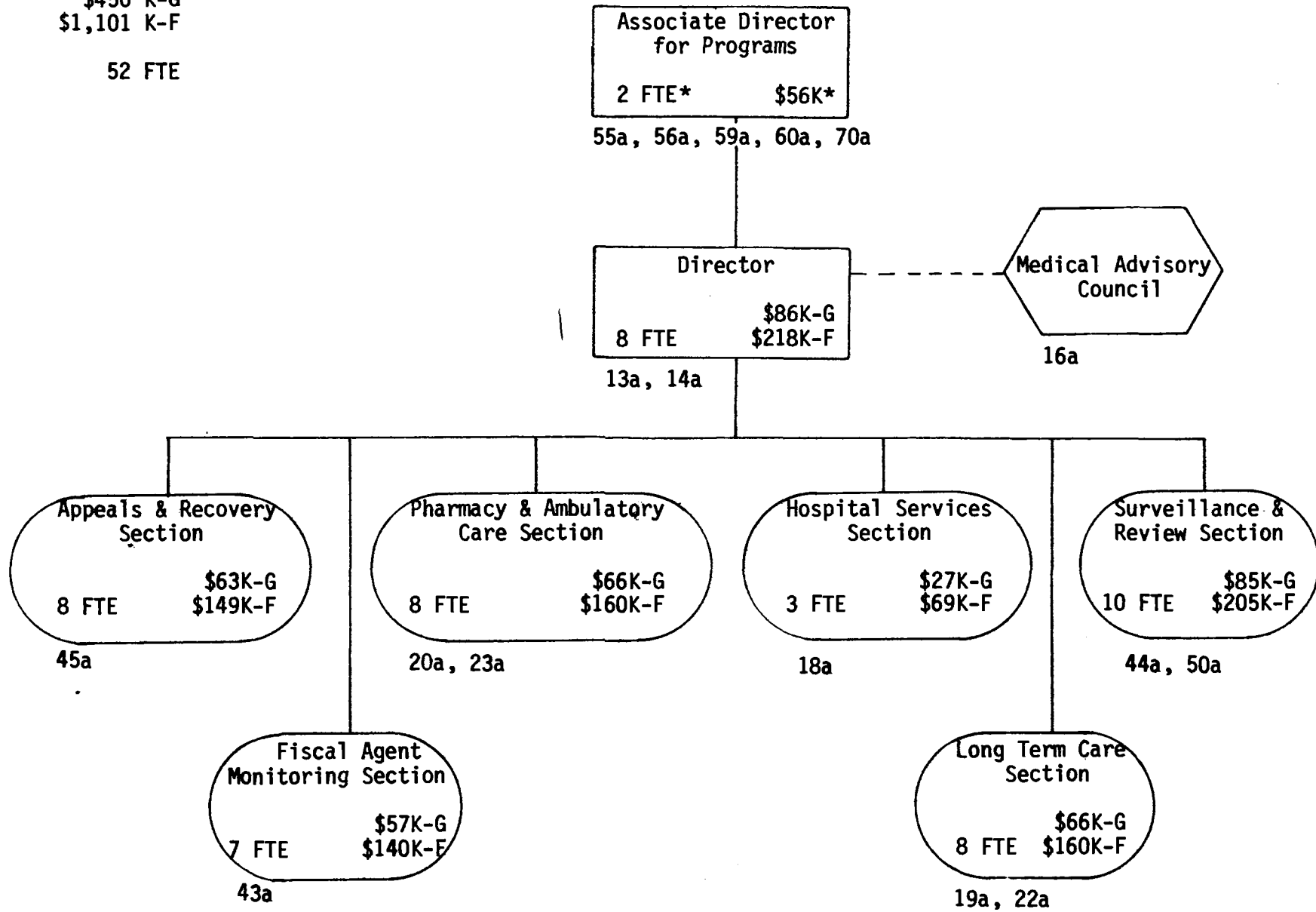

* Not included in division totals.

OPERATIONS

Area Totals:

\$960 K-G

\$919 K-F

\$843 K*

80.5 FTE

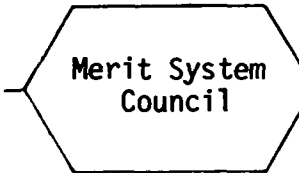
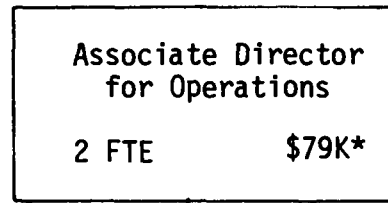

62a

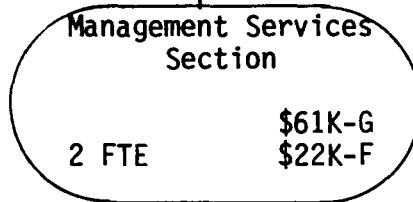

51a, 63a, 74a

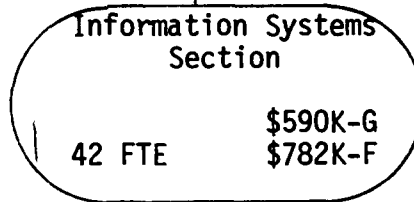

54a

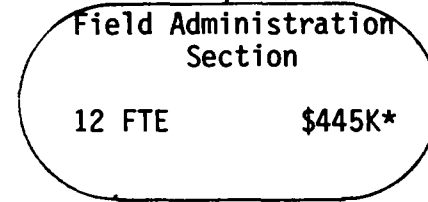

53a

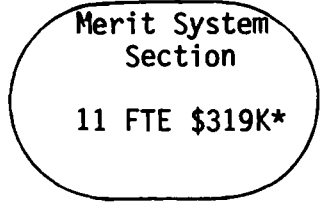

72a

SS-23

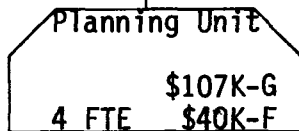

58a

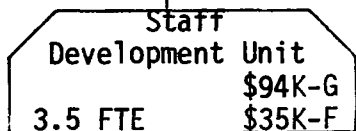

75a, 76a

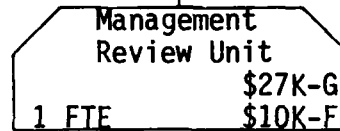

40a

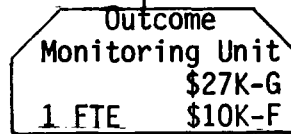
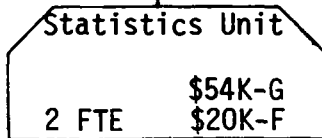

52a

* Funding sources not available.

DIVISION OF REHABILITATION

Division Totals:

\$2,153 K-G
\$7,934 K-F
431.5 FTE

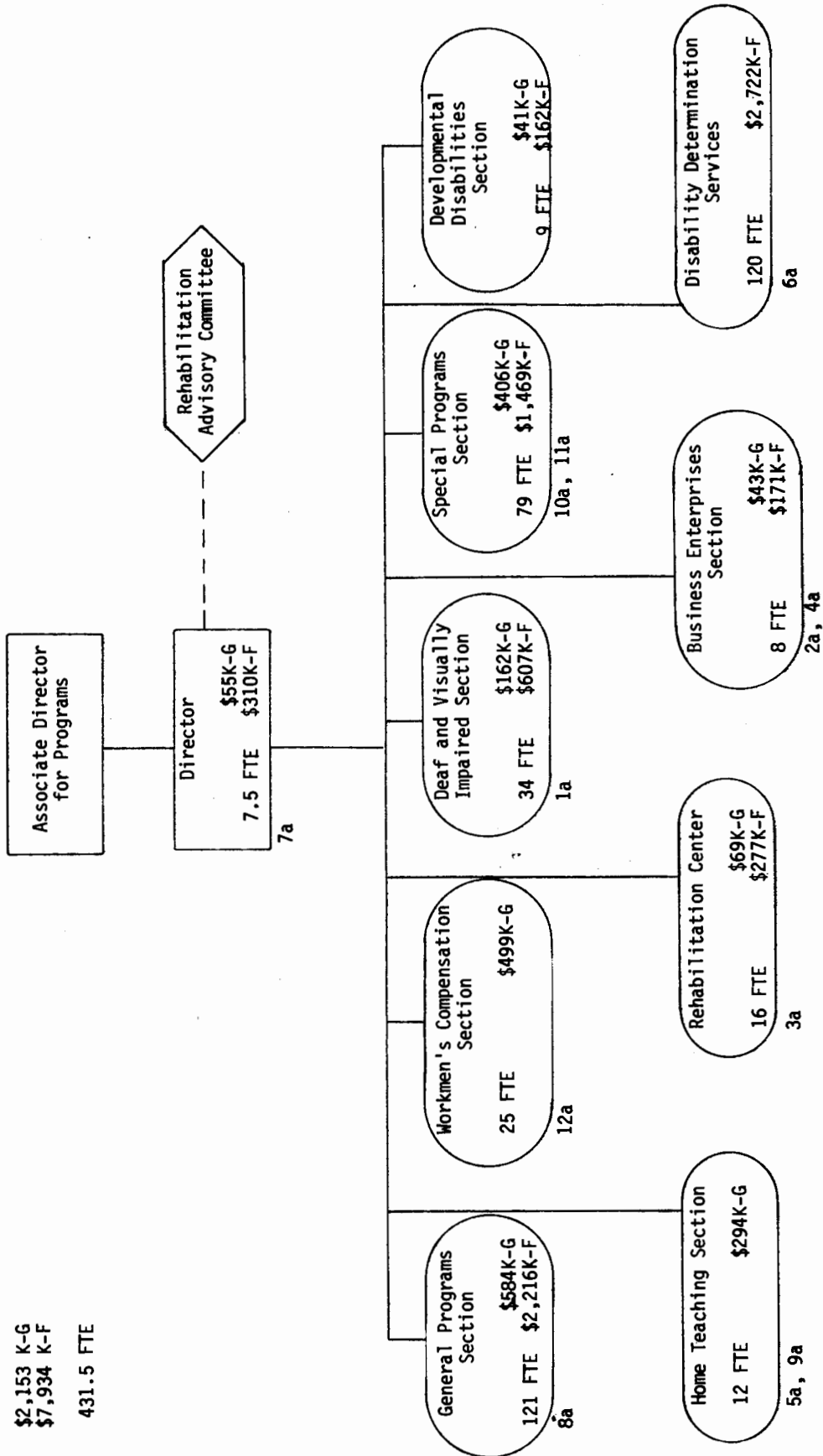

Division Totals:

\$2,610 K-G
 \$2,673 K-C
 \$277 K*

233.7 FTE

DIVISION OF VETERANS AFFAIRS

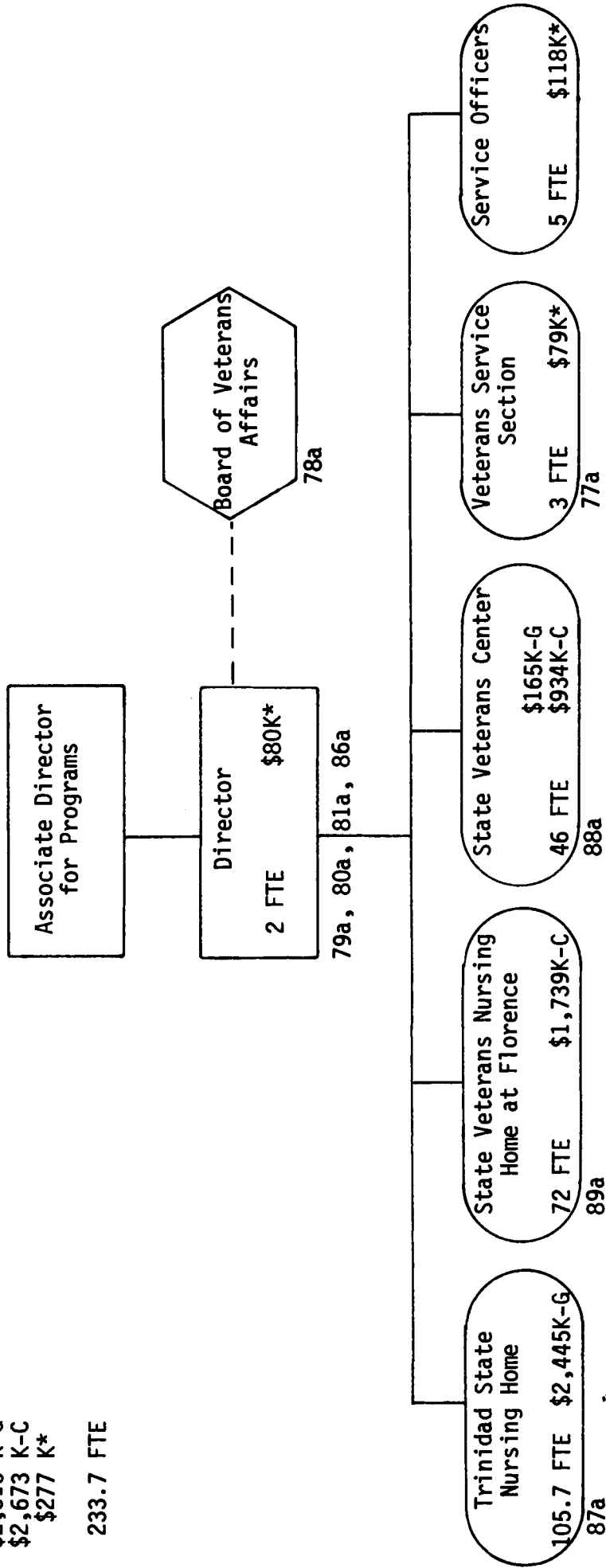

* Funding sources not provided.

DEPARTMENT OF STATE

Page

Accepts Business Filings,
Approves Business Incorporations and
Performs Licensing Functions

ST-1 Commercial Enterprise Filings.....

ST-2 Incorporations.....

ST-2 Not for Profit.....

ST-2 Professional.....

ST-2 Profit.....

ST-4 Licensing.....

Administers Election Activities
and Other Related Functions

ST-5 Elections.....

ST-6 Initiatives and Referenda.....

Performs Internal Administrative Functions

ST-6

Serves as a Depository for Records Including
Those of Public Agencies and Officials
and as an Agent in Legal Proceedings

ST-8 Hearings.....

ST-8 Lobbyists.....

ST-8 Public Officials.....

ST-9 Publications.....

ST-10 Reapportionment.....

ST-10 Service of Process.....

DEPARTMENT OF STATE

Accepts Business Filings,
Approves Business Incorporations and
Performs Licensing Functions

Commercial Enterprise Filings

1. Files financing statements and related documents of secured parties to perfect their interest in the collateral of a debtor engaged in a commercial enterprise. (Division of Commercial Recordings, Uniform Commercial Code; 4-9-401 (5), C.R.S. 1973)
2. Registers the reservation and transfers of name for limited partnerships in the state. (Division of Commercial Recordings, Corporations Section; 7-62-103 (2), C.R.S. 1973)
3. Handles certificates of limited partnership, authorizing them to do business in Colorado and maintains a file of information on each limited partnership. (Division of Commercial Recordings, Corporations Section; 7-62-201 (1), C.R.S. 1973)
4. Issues certificates of registration to foreign limited partnerships enabling them to transact business in the state and maintains a file of information on each foreign limited partnership. (Division of Commercial Recordings, Corporations Section; 7-62-903 (1), C.R.S. 1973)
5. Registers trademarks. (Division of Commercial Recordings, Corporation Section; 7-70-102 (1), C.R.S. 1973)
6. Registers trade names for persons doing business in the state. (Division of Commercial Recordings, Uniform Commercial Code; 7-71-101 (1), C.R.S. 1973)
7. Registers trade names for corporations and limited partnerships doing business in the state. (Division of Commercial Recordings, Corporations Section; 7-71-101 (2), C.R.S. 1973)
8. Maintains a schedule of property and a list of creditors relating to bulk transfers. (Division of Commercial Recordings, Uniform Commercial Code; 4-6-104 (1) (c), C.R.S. 1973)
9. Accepts the filing of notices of liens on personal property owned by a corporation or partnership. (Division of Commercial Recordings, Uniform Commercial Code; 38-25-102 (2) (a) and 38-25-104 (1) (a), C.R.S. 1973)

Incorporations

Not for Profit

10. Issues certificates of incorporation for nonprofit corporations to do business in Colorado and maintains a file of information on each incorporated body. (Division of Commercial Recordings, Corporations Section; 7-40-101 (1), C.R.S. 1973)
11. Issues certificates of authority to foreign nonprofit corporations enabling them to conduct affairs in the state and maintains a file of information on each incorporated body. (Division of Commercial Recordings, Corporations Section; 7-27-106 (1), C.R.S. 1973)

Professional

12. Issues certificates of incorporation for the practice of accounting, architecture, podiatry, engineering, dentistry, veterinary medicine, law, medicine, optometry, physical therapy and psychology and maintains a file of information on each incorporated body. (Division of Commercial Recordings, Corporations Section; 7-3-115, 12-2-117 and 118, 12-4-110, 12-32-109 (2), 12-25-103, 12-35-112 (1), 12-64-111 (3), Colorado Rule of Civil Procedure 265 II, 12-33-124 (2), 12-36-134 (2), 12-40-125 (2), 12-41-125 (2), and 12-43-118 (2), C.R.S. 1973)
13. Issues certificates of incorporation for professional service corporations for chiropractic practice, and maintains a file of information on each incorporated body. (Division of Commercial Recordings, Corporations Section; 12-33-124 (2), C.R.S. 1973)

Profit

14. Issues certificates of incorporation for domestic and foreign profit corporations authorizing them to do business in Colorado and maintains a file of information on each incorporated body. (Division of Commercial Recordings, Corporations Section; 7-2-103 (1) and 7-9-101 (1), C.R.S. 1973)
15. Files certificates of incorporation for state and industrial banks and maintains a file of information on each incorporated body. (Division of Commercial Recordings, Corporations Section; 11-3-109 (3) and 11-22-102 (4), C.R.S. 1973)

16. Issues certificates of incorporation for trust companies, credit unions, savings and loan associations and insurance companies and maintains a file of information on each incorporated body. (Division of Commercial Recordings, Corporations Section; 7-2-101 and 11-23-104, 11-30-101 (4), 11-41-109 (2), and 10-3-101 (1), C.R.S. 1973)
17. Issues special purpose certificates of incorporation for telegraph companies for the purpose of constructing a line of magnetic telegraph in this state and maintains a file of information on each incorporated body. (Division of Commercial Recordings, Corporations Section; 240-101 (1) and 7-41-101, C.R.S. 1973)
18. Issues special purpose certificates of incorporation for ditch and reservoir companies for the purpose of constructing a ditch, reservoir, or pipeline to convey water to any mine, mill or land for storing the same and maintains a file of information on each incorporated body. (Division of Commercial Recordings, Corporations Section; 7-40-101 (1) and 7-42-101, C.R.S. 1973)
19. Issues special purpose certificates of incorporation for flume and pipeline companies for the purpose of constructing a flume or a pipeline for the conveyance of gas, water, or oil and maintains a file of information on each incorporated body. (Division of Commercial Recordings, Corporations Section; 7-40-101 (1) and 7-43-101 and 7-43-102, C.R.S. 1973)
20. Issues special purpose certificates of incorporation for water users' associations and maintains a file of information on each incorporated body. (Division of Commercial Recordings, Corporations Section; 7-40-101 (1) and 7-44-101, C.R.S. 1973)
21. Issues special purpose certificates of incorporation for toll road companies and maintains a file of information on each incorporated body. (Division of Commercial Recordings, Corporations Section; 7-40-101 (1) and 7-45-101, C.R.S. 1973)
22. Issues special purpose certificates of incorporation for the purpose of constructing a bridge or establishing a ferry over any of the streams of water in the state and maintains a file of information on each incorporated body. (Division of Commercial Recordings, Corporations Section; 7-40-101 (1) and 7-46-101, C.R.S. 1973)

23. Issues special purpose certificates of incorporation for cemetery companies for the purpose of procuring and establishing a cemetery and maintains a file of information on each incorporated body. (Division of Commercial Recordings, Corporations Section; 7-40-101 (1) and 7-47-101, C.R.S. 1973)
24. Issues special purpose certificates of incorporation for business development corporations organized for the purposes of promoting business prosperity and economic welfare and maintains a file of information on each incorporated body. (Division of Commercial Recordings, Corporations Section; 7-40-101 (1) and 7-48-101, C.R.S. 1973)
25. Issues authorization for churches, congregations, and religions, educational or benevolent societies to incorporate and maintains a file of information on each incorporated body. (Division of Commercial Recordings, Corporations Section; 7-50-101 (1), C.R.S. 1973)
26. Issues certificates of incorporation for cooperative associations and cooperative marketing associations and maintains a file of information on each incorporated body. (Division of Commercial Recordings, Corporations Section; 7-55-102, and 7-56-109 (2), C.R.S. 1973)
27. Issues certificates of incorporation for agricultural and livestock associations and maintains a file of information on each incorporated body. (Division of Commercial Recordings, Corporations Section; 7-57-102, C.R.S. 1973)

Licensing

28. Licenses and regulates all bingos, raffles and games of chance within the state. (Division of Licensing and Elections, Licensing and Enforcement Section; 12-9-103 (1), C.R.S. 1973)
29. Licenses notaries public and enforces the notary law. (Division of Licensing and Elections, Licensing and Enforcement Section; 12-55-101 (1) and 107 (1), C.R.S. 1973)
30. Licenses manufacturers and vendors of fireworks. (Division of Licensing and Elections, Licensing and Enforcement Section; 12-28-106 (1), C.R.S. 1973)

Administers Election Activities
and Other Related Functions

Elections

31. Acts as the chief elections officer of the State. (Secretary of State; 1-1-106, C.R.S. 1973)
32. Provides for the uniform application of the provisions of the Colorado election code in all counties of the state. (Division of Licensing and Elections, Elections Section; 1-1-106 (1) (c) and 1-1-107, C.R.S. 1973)
33. Supervises the conduct of primary, general, and congressional vacancy elections in this state. (Division of Elections and Licensing, Elections Section; 1-1-106 (1) (a), C.R.S. 1973)
34. Administers the state's campaign reform act. (Division of Licensing and Elections, Elections Section; 1-45-113, C.R.S. 1973)
35. Provides for the filing of information required by the state's campaign reform act of all candidates for statewide election, the general assembly, the office of district attorney, the office of district court judge, and political committees in support or opposition to such candidates or statewide issues. (Division of Licensing and Elections, Elections Section; 1-45-104 (1), C.R.S. 1973)
36. Canvasses, certifies and counts final election results. (Division of Licensing and Elections, Elections Section; 1-10-104, 1-10-201, 1-40-113, and 32-8-103, C.R.S. 1973)
37. Compiles and maintains the master list of electors. (Division of Licensing and Elections, Elections Section; 1-2-301, C.R.S. 1973)
38. Investigates possible violations of the Colorado election code and enforces proper methods of conduct. (Division of Licensing and Elections, Elections Section; 1-1-106 (2), C.R.S. 1973)
39. Prepares and mails an election ballot to certified employees of the state personnel system for the election of members to the State Personnel Board. (Division of Licensing and Elections, Elections Section; 24-50-103 (3) (b), C.R.S. 1973)

Initiatives and Referenda

40. Designates all initiated petition ballot titles and prepares submission clauses. (Secretary of State; Initiative, Referendum, and Ballot Title Board; 1-40-101, C.R.S. 1973)
41. Accepts and reviews all petitions for initiative or referendum law or constitutional amendment. (Secretary of State, Initiative, Referendum, and Ballot Title Board; 1-40-104, C.R.S. 1973)

Performs Internal Administrative Functions

42. Administers the responsibilities and duties of the Department of State. (Secretary of State; 24-21-101, C.R.S. 1973)
43. Coordinates and administers all computer functions employed by the department. (Division of Administration, Computer Programming Section; no state statutory mandate)
44. Administers the department's appropriation for the Oregon Legal Services Plan. (Division of Administration; 24-21-101, C.R.S. 1973)
45. Examines and reviews, as a member of the State Board of Equalization, the abstracts of assessment of each county. (Secretary of State; 39-9-103, C.R.S. 1973)
46. Collects fees for the filing of documents and the issuing of certificates as required by law for corporations and associations. (Division of Administration, Accounting Budget, Personnel Section; 7-10-103 and 104, and 7-28-103, and 7-71-101 (5) and (8) (a), C.R.S. 1973)
47. Prepares the department budget. (Division of Administration, Accounting/Budget, Personnel Section; 24-21-101, C.R.S. 1973)
48. Charges fees as required by law for official papers and work provided by the Department of State. (Division of Administration, Accounting/Budget, Personnel Section; 24-21-104, C.R.S. 1973)
49. Authorizes and issues payment for all expenditures of the department. (Division of Administration, Accounting/Budget, Personnel Section; 24-21-104 (3) (c), C.R.S. 1973)

50. Serves as custodian for the Colorado state seal. (Secretary of State; Constitution of Colorado Article IV, Section 18, and 24-80-903, C.R.S. 1973)
51. Attests to land patents which may be ordered sold or which are sold or disposed of by the State Board of Land Commissioners under Colorado statute. (Secretary of State; 36-1-104, C.R.S. 1973)
52. Countersigns all commissions issued by the governor and registers each commission. (Division of Licensing and Elections, Election Section; 24-21-103, C.R.S. 1973)

Serves as a Depository for Records Including
Those of Public Agencies and Officials
and as an Agent in Legal Proceedings

53. Maintains files of city and town incorporation papers, reorganization documents, home rule charters and municipal name changes. (Division of Licensing and Elections, Licensing and Enforcement Section; Constitution of Colorado Article XX Section 5 and 31-2-103 (2), C.R.S. 1973).
54. Acts as the depository for acts passed by the Colorado legislature or vetoed by the governor. (Division of Licensing and Elections, Elections Section; 24-21-101 and 24-70-204 (2) (c), C.R.S. 1973)
55. Acts as the depository for all original journals of the Colorado Senate and the Colorado House of Representatives and for a verified and complete set of the Colorado Revised Statutes. (Division of Elections and Licensing; 2-2-310, C.R.S. 1973)
56. Files all executive declarations pertaining to disaster emergencies. (Division of Administration; 28-2-104 (4), C.R.S. 1973)
57. Maintains a file of all official documents pertaining to extradition. (Division of Administration; 16-19-124 (3), C.R.S. 1973)
58. Accepts filings of any justice of the supreme court or any judge of any court of record declaring his or her intent to retain judicial office. (Division of Licensing and Elections, Elections Section; Constitution of Colorado, Article VI, Section 25)
59. Accepts filings stating potential conflicting interests of any public servant who exercises any substantial discretionary function in connection with government

and Licensing, Elections Section; 18-8-308, C.R.S. 1973)

60. Accepts filings of all manual signatures certified under oath and of old facsimile signatures for authorized public officials. (Division of Elections and Licensing, Elections Section; 11-55-103, C.R.S. 1973))

Hearings

61. Plans, administers and conducts hearings authorized by law for the Secretary of State and prepares the decisions. (Division of Administration, and Division of Licensing and Elections, Elections and Licensing and Enforcement Sections; 24-21-108, C.R.S. 1973))
62. Conducts public hearings on complaints against anyone holding a bingo or raffles license. (Secretary of State; 12-9-103 (1) (c), C.R.S. 1973))
63. Conducts hearings regarding the revocation of licenses granted to notaries public. (Secretary of State; 12-55-107, C.R.S. 1973))
64. Conducts hearings on complaints of violations regarding the state's campaign reform act. (Secretary of State, and Division of Licensing and Elections, Elections and Licensing and Enforcement Sections; 1-45-113 (2), C.R.S. 1973))
65. Conducts public hearings on protests of initiative titles and petitions. (Secretary of State and Division of Licensing and Elections, Elections and Licensing and Enforcement Sections; 1-40-109, C.R.S. 1973))
66. Hears protests to recall election petitions for state and district offices. (Secretary of State and Division of Licensing and Elections, Elections and Licensing and Enforcement Sections; 24-9.5-103 (2), C.R.S. 1973))

Lobbyists

67. Registers and regulates professional lobbyists under the Colorado "sunshine law". (Division of Licensing and Elections, Licensing and Enforcement Section; 24-6-303, C.R.S. 1973))

Public Officials

68. Provides for the filing of personal financial statements by the state's public officials for public view and access.

(Division of Licensing and Elections, Elections Section; 24-6-202, C.R.S. 1973)

69. Provides for the filing of official bonds conditional upon the faithful performance of duties and responsibilities of clerks of district courts. (Division of Licensing and Elections, Elections Section; 24-13-103, C.R.S. 1973)
70. Accepts the oaths of office for all officers of the executive department, judges of the supreme and district courts, and district attorneys. (Division of Licensing and Elections, Elections Section; Constitution of Colorado, Article XII, Section 9)

Publications

71. Prepares publications for the information of the general public on election issues, Colorado corporations, and the Uniform Commercial Code. (Division of Administration, Accounting/Budget, Personnel Section, Division of Commercial Recordings and Division of Licensing and Elections; 24-21-107, C.R.S. 1973)
72. Publishes on a weekly basis The Corporate Reporting Service listing new corporations. (Division of Commercial Recordings, Corporations Section; no state statutory mandate)
73. Publishes the certified title and text of each constitutional amendment, initiated, or referred measure in every legal newspaper as prescribed by law. (Division of Licensing and Elections, Elections Section; 1-40-114, C.R.S. 1973)
74. Distributes publications on registration and election procedures, recall statutes, lobbyists, bingo and raffles, notary application, Colorado corporations and the uniform commercial code to the state law library. (Division of Administration, Division of Commercial Recordings and Division of Elections and Licensing; 24-90-204, C.R.S. 1973)
75. Prepares and promulgates rules and regulations for the department to enable the discharge of duties required by law. (Division of Administration; 24-21-101, C.R.S. 1973)
76. Publishes the Colorado abstract of votes for all state and district offices. (Division of Licensing and Elections, Elections Section; 1-10-201, C.R.S. 1973)
77. Compiles and causes to be published the Code of Colorado Regulations and the Colorado Register from those agencies

filing their rules and regulations and notices of rule with the Secretary of State. (Division of Licensing and Elections, Licensing and Enforcement Section; 24-4-103 (11) (a) and (b), C.R.S. 1973)

Reapportionment

78. Maintains a file of copies of census maps showing each state and congressional, senatorial and representative district and the population of each district according to the official census data. (Division of Licensing and Elections, Elections Section; 2-2-107, C.R.S. 1973)

Service of Process

79. Acts as the designated agent for service of process for nonresident cigarette wholesalers. (Division of Commercial Recordings, Corporations Section; 39-28-106, C.R.S. 1973)
80. Acts as agent for service of process for nonresident agents of corporations if such corporations fail to appoint or maintain a registered agent in this state. (Secretary of State; 7-9-119, C.R.S. 1973)
81. Acts as agent for service of process on corporations if such corporations fail to appoint or maintain a registered agent in this state. (Secretary of State; 7-3-112, 7-9-119, 7-22-106 and 7-27-110, C.R.S. 1973)
82. Acts as agent for service of process on limited partnerships if such limited partnerships fail to appoint or maintain a registered agent in this state. (Secretary of State; 7-62-108 and 7-62-909, C.R.S. 1973)
83. Acts as designated agent for service of process for nonresidents applying for registration of pesticides. (Secretary of State; 35-9-104, C.R.S. 1973)
84. Acts as designated agent for service of process for nonresident real estate brokers and salesmen. (Secretary of State; 12-61-107, C.R.S. 1973)
85. Acts as designated agent for service of process for nonresident employers with regard to workmen's compensation. (Secretary of State; 8-53-103 (4), (5) and (6), C.R.S. 1973)

DEPARTMENT OF STATE

Department Totals:

\$1,239 K-G

51.3 FTE

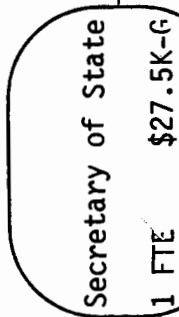
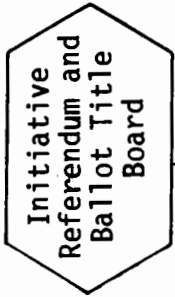

31a, 42a, 45a, 50a, 51a, 62a, 63a, 64b-66b, 80a-85a

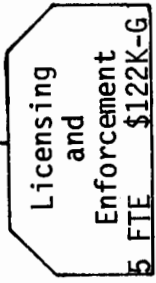
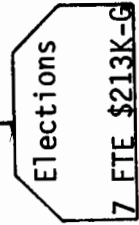
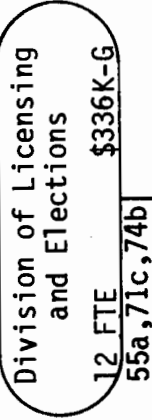
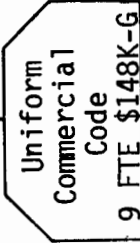
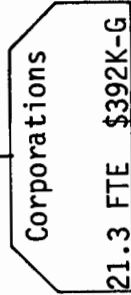
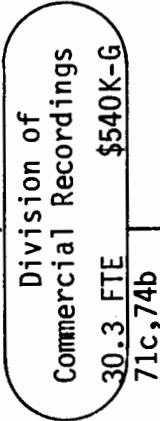
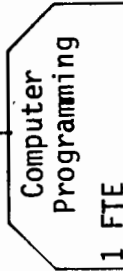
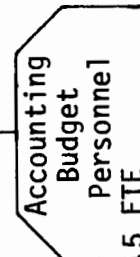
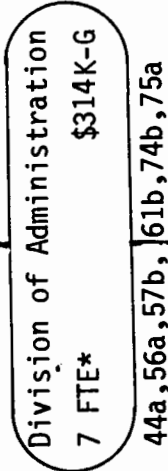

* Includes executive secretary

OFFICE OF STATE PLANNING AND BUDGETING

Page

Coordinates Short and Long Range
State Level Planning

Planning Coordination.....	OSPB-1
Program Oversight.....	OSPB-1
Research for Planning.....	OSPB-2

Coordinates the Annual Executive Budget
Formulation and Execution Process

Budget Execution.....	OSPB-2
Executive Budget Preparation.....	OSPB-3
Financial Planning.....	OSPB-3
Technical Assistance for Budget Preparation.....	OSPB-4

OFFICE OF STATE PLANNING AND BUDGETING

Coordinates Short and Long Range State Level Planning

Planning Coordination

1. Develops long-range plans for both operating and capital construction budgets and for the state revenue structure. (Office of Executive Director; 24-37-102 (1) (b) C.R.S., 1973)
2. Coordinates the preparation and maintenance of long-range master plans which recommend executive and legislative actions for achieving desired state objectives and which include recommended methods for evaluation. (Division of Planning; 24-37-202 (1) (a) C.R.S., 1973).
3. Develops, or causes to be developed, current operational master plans for each state institution and agency, except state schools, colleges and universities for submission to the general assembly. (Division of Budget Operations/Execution; 24-37-301 (1) (g) C.R.S. 1973).
4. Develops long-range fiscal plans for both operating and capital construction budgets and for the state revenue structure, such plans to be consistent with the policies and objectives of state planning. (Division of Budget Operations/Execution; 24-37-405 (1) (n) C.R.S., 1973).
5. Stimulates, encourages and assists state agencies to engage in long-range and short-range planning in their respective areas of responsibility. (Division of Planning; 24-37-202 (1) (b) C.R.S., 1973).
6. Reviews and coordinates the planning efforts of state agencies including the relationship of such efforts with federal and local governmental programs. (Division of Budget Operations/Execution; 24-37-202 (1) (c) C.R.S. 1973).
7. Prepares and from time to time revises an inventory of public and private natural resources, of major public and private works and other facilities and information which are deemed of importance in planning for the development of the state. (Division of Planning; 24-37-202 (1) (h) C.R.S. 1973).

Program Oversight

8. Continually reviews and recommends revisions of the plans, policies and programs of state agencies; proposes alternative methods for accomplishing the objectives of state programs and policies; and develops and implements, in coordination with the

state controller, a system for evaluating the result of governmental expenditures. (Division of Budget Operations/Execution; 24-37-405 (1) (m) C.R.S., 1973).

Research for Planning

9. Makes studies and inquiries relevant to the problems of agriculture, industry and commerce, as well as population and urban growth, local government and related matters affecting the development of the state. (Divisions of Planning and Budgeting; 24-37-202 (1) (g) C.R.S., 1973).
10. Furnishes state agencies with data, projections and other technical assistance to discharge their planning responsibilities and coordinates the exchange of relevant reports, data and projections among state agencies. (Division of Planning; 24-37-202 (1) (d) C.R.S., 1973).
11. Makes recommendations to the governor on appointees to the Governor's Revenue Estimating Advisory Committee; presides over meetings of and provides the staff of that group; and, with the advice of the group, develops and prepares the annual general revenue fund estimate. (Office of Executive Director, and Division of Economic Research; 24-37-405 (1) (e) C.R.S., 1973).

Coordinates the Annual Executive Budget Formulation and Execution Process

Budget Execution

12. Develops the annual executive planning, programming and budgeting cycle and, when applicable, coordinates such an effort with the Commission on Higher Education and other agencies involved with planning. (Office of Executive Director; 24-37-102 (1) (a), 24-37-405 (1) (c) (d) C.R.S., 1973).
13. Executes the appropriations acts or other acts having fiscal implications by source of funds, personnel authorizations, contingency and performance requirements and legislative intent. (Office of Executive Director, and Division of Budget Operations/Execution; 24-37-301 (1) (e) C.R.S., 1973).
14. Develops and enforces a method of internal audit that will assure compliance with appropriations provisions and executive orders. (Division of Budget Operations/Execution; 24-37-301 (1) (m) C.R.S., 1973).
15. Reviews for the governor all transfers between appropriations and all work programs recommended by the controller. (Division of Budgeting; 24-37-405 (1) (k) C.R.S., 1973).

Executive Budget Preparation

16. Assists the governor in the preparation and administration of the executive budget. (Office of Executive Director, Division of Budgeting; 24-37-404 (1), 24-37-405 (1) and 24-37-301 (1) (b) (c) C.R.S., 1973)
17. Designs and prepares, in coordination with the joint budget committee of the general assembly, the form and instructions to be used in the preparation of all budget requests except those pertaining to higher education. Reviews and approves the forms and instructions for higher education budget requests which are prescribed by the Colorado Commission on Higher Education. (Division of Budget Operations/Execution; 24-37-405 (1) (a) (b) C.R.S., 1973)
18. Assists the governor in his formulation of budget proposals by developing recommendations and preparing the annual executive budget proposal, together with legislative bills embodying such proposals. (Division of Budget Operations/Execution; 24-37-405 (1) (g) C.R.S., 1973)
19. Develops procedures governing the submission of state requests for funds to non-state agencies and reviews for the governor all such requests requiring the commitment or expenditure of state funds. Advises the joint budget committee of the general assembly, prior to submission for approval, of any requests committing the state to a program which has not theretofore had the approval of the general assembly. (Division of Budget Operations/Execution, and Office of Executive Director; 24-37-405 (1) (1) C.R.S., 1973)

Financial Planning

20. Annually evaluates plans, policies, programs and budget requests of all departments, institutions and agencies of the executive branch of state/government. Insures submission to the joint budget committee by November 1, with submission of executive budget recommendation by January 1 of each year. (Division of Budget Operations/Execution, and Economic Research; 24-37-301 (1) (a) (b) (c) C.R.S., 1973)
21. Assists state agencies in complying with the joint budget committee in administering the provisions of laws concerning a zero-base budgeting program review. (Office of Executive Director; 24-37-102 (1) (d) C.R.S., 1973)
22. Receives and expends grants, gifts, bequests and contractual assistance involving non-state funds as these funds become available to the department. (Office of Executive Director; 24-37-106 C.R.S., 1973)

23. Publishes statewide administrative regulations. (Office of Executive Director, and Division of Budgeting; 24-37-405 (2) C.R.S., 1973)
24. Acts as reviewing authority or otherwise provides cooperative services under any federal-state planning programs. (Division of Planning; 24-37-202 (1) (k) C.R.S., 1973)
25. Reviews pending legislation and determines the economic impact of such legislation upon the people of the state. (Office of Executive Director, and Divisions of Budgeting and Planning; 24-37-102 (1) (c) C.R.S., 1973)
26. Prepares fiscal notes for the general assembly on pending legislation as it affects city, county or other local agencies. (Divisions of Planning, Budget Operations/Execution, Economic Research; 24-37-301 (1) (f), 24-37-405 (1) (j) C.R.S., 1973)

Technical Assistance for Budget Preparation

27. Conducts public hearings to encourage maximum public understanding of factual data and assumptions upon which projections and analyses are based and also to receive suggestions regarding the type of projections and analyses that are needed. (Office of Executive Director; 24-37-202 (1) (e) C.R.S., 1973)
28. Conducts annual executive budget hearings on the plans, programs, policies and budget requests of all agencies in the executive department. (Office of Executive Director, and Division of Budgeting; 24-37-405 (1) (f) C.R.S., 1973)
29. Designs, develops and presents briefings to the joint budget committee, the general assembly, the general public and other interested parties on the annual executive budget proposals. (Office of Executive Director, and Division of Budgeting; 24-37-405 (1) (h) C.R.S., 1973)

Department Totals

\$794 K-G
\$825 K-C
\$166 K-F

49 FTE

OFFICE OF STATE PLANNING AND BUDGETING

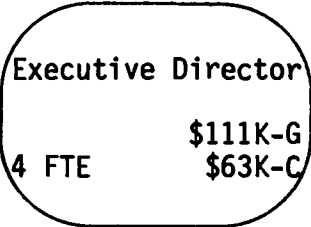

1a,11b,12a,13b,16b,17c,19b,
21a,22a,23b,25b,26c,27a,28b,29b

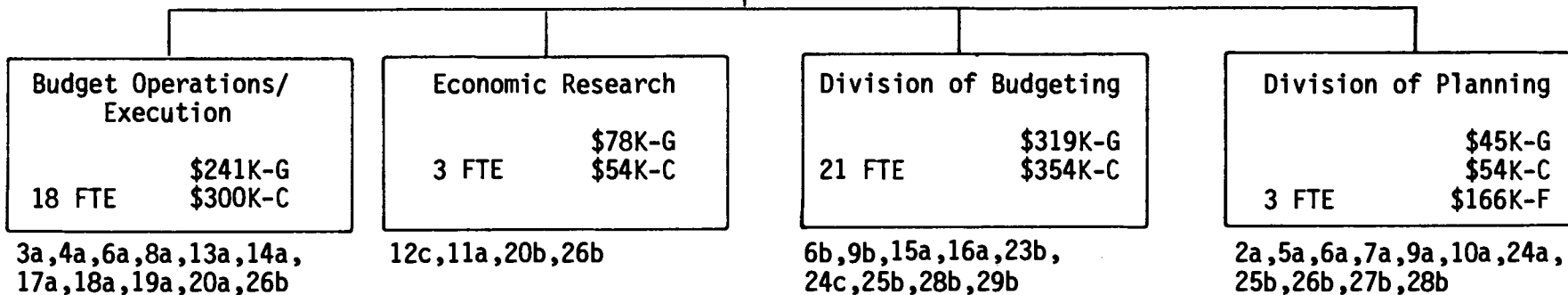

OSP-5

DEPARTMENT OF TREASURY

Page

Deposits State Moneys

Reports.....	TR-1
Trusts and Tax Funds and Fees.....	TR-1
Deposit of State Moneys.....	TR-2

Pays Warrants

TR-2

Holds, Manages and Invests State Moneys

Escheats.....	TR-2
---------------	------

DEPARTMENT OF THE TREASURY

Deposits State Moneys

1. Accepts gifts, legacies and other property on behalf of the state. (Accounting Division; 24-22-105, C.R.S. 1973)
2. Provides custody and safekeeping for all securities for which the treasurer is the official custodian. (Custodial Division; (24-22-106, C.R.S. 1973))
3. Receives moneys collected by the agencies of state government. (Cashiers Division, Accounting Division, Administrative Division, Investment Division and Custodial Division; 24-36-102, C.R.S. 1973)

Reports

4. Makes quarterly and annual reports on the condition of the state treasury. (Accounting and Administrative Divisions; 24-36-102, C.R.S. 1973)
5. Compiles daily reports of all receipts and disbursements. (Accounting and Cashier Divisions; 24-36-105, C.R.S. 1973)

Trusts and Tax Funds and Fees

6. Holds moneys from sales, bonuses and leases of oil shale lands. (Accounting Division; 34-63-104, C.R.S. 1973)
7. Receives and distributes moneys received under the Taylor Grazing Act. (Accounting Division; 35-45-108, C.R.S. 1973)
8. Holds moneys from the State Board of Land Commissioners Land and Water Management Fund. (Custodial, Division; 36-1-148, C.R.S. 1973)
9. Receives and distributes Colorado State Forest Fund moneys. (Accounting Division; 36-7-202, C.R.S. 1973)
10. Holds Highway Users Tax Fund and Highway Crossing Protection Fund moneys. (Accounting Division; 43-4-201, C.R.S. 1973)

Deposit of State Moneys

11. Selects national or state banks for the receipt of moneys deposited by the state treasurer. (Administrative Division; 24-36-104, C.R.S. 1973)

Pays Warrants

12. Pays warrants and maintains a list of the same drawn upon the treasury by the state division of accounts and control. (Accounting Division; 24-36-106, C.R.S. 1973)

Holds, Manages and Invests State Moneys

13. Establishes certificates of deposit in banks and savings and loan associations. (Investment Division; 24-36-112, C.R.S. 1973)
14. Appoints persons to act as custodians of state moneys deposited in banking institutions. (Administrative Division; 24-36-109, C.R.S. 1973)
15. Invests in short term interest-bearing securities. (Investment Division; 24-36-113, C.R.S. 1973)
16. Provides for the safekeeping and management of public funds. (Custodial Division; Article X, Section 12, Colorado State Constitution)
17. Serves as agent for State Compensation Insurance Fund moneys not needed for immediate use. (Investment and Custodial Divisions; 8-51-111, C.R.S. 1973)
18. Issues University Anticipation Warrants. (Cashier Division; 23-20-125 and 23-31-130, C.R.S. 1973)

Escheats

19. Holds moneys due creditors and shareholders or from associations or estates when those authorized to receive these funds cannot be located. (Accounting Division; 7-8-123, 11-41-132 and 15-112-914, C.R.S. 1973)

Department Totals:

\$427 K-G

15 FTE

DEPARTMENT OF THE TREASURY

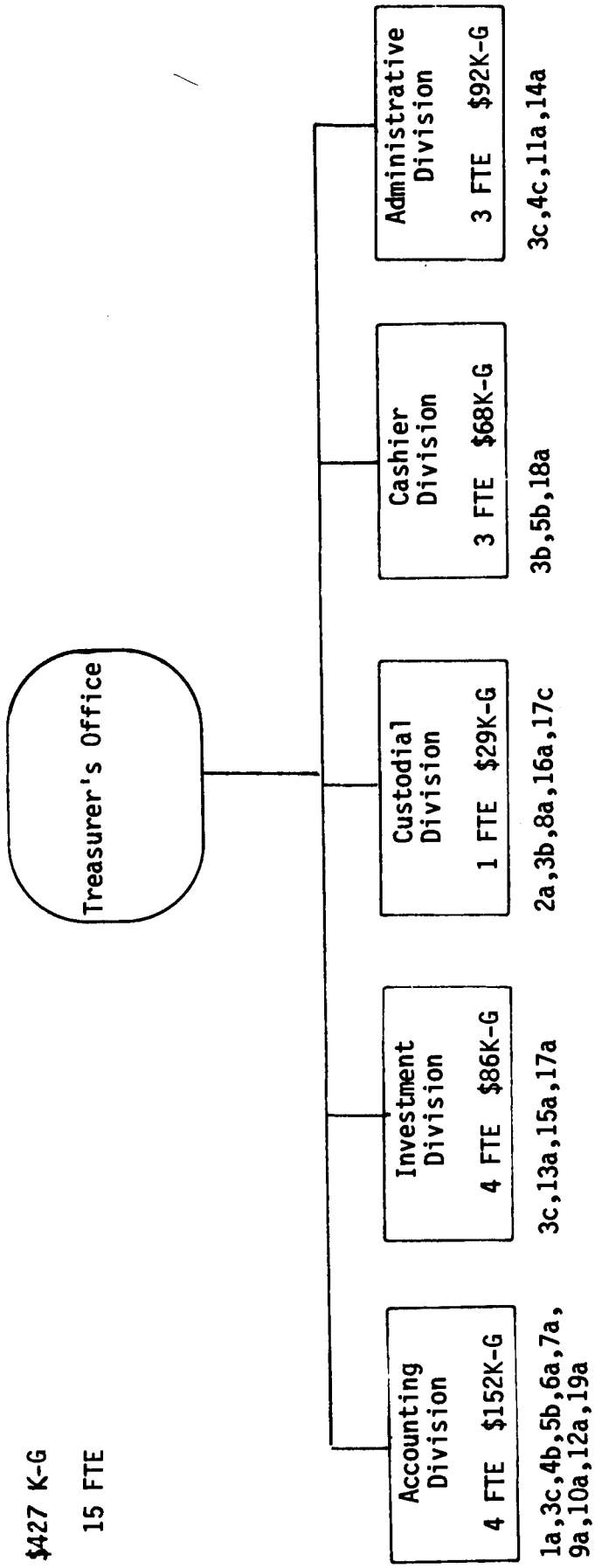

I N D E X

- A -

	<u>Page</u>
Abs tractors	
Annual Report.....	RA-12
Licensure.....	RA-5,24
Accountants	
Regulation.....	RA-3,5,10,23,25
Accounting	
Centralized Executive Departments.....	AD-6
Adams State College, see Higher Education	
Administration, Department of.....	AD-1
Administration, of Departments of State Government	
Corrections.....	CO-1,5-8
Higher Education.....	HE-4
Institutions.....	IN-1
Labor and Employment.....	LE-1,2,4-8
Automated Data Processing.....	LE-1
Budgeting, Financial Services and Planning.....	LE-1
Management Operations and Administrative Support Services.....	LE-4
Personnel and Staff Development.....	LE-7
Research and Development.....	LE-8
Law.....	L-1
Legislative.....	LEG-2,6
Military Affairs.....	MA-2
Natural Resources.....	NR-22
Personnel.....	PER-1,3
Regulatory Agencies.....	RA-27-28
Revenue.....	REV-4,6,7
Secretary of State.....	ST-6
Social Services.....	SS-6
Administration.....	SS-6
Audits and Accounting.....	SS-8
Budgeting.....	SS-9
Intergovernmental Affairs.....	SS-10
Personnel.....	SS-10
Administrative Services, Centralized to Executive Departments	
Automated Data Processing.....	AD-1
ADP Services.....	AD-1
Statewide Planning.....	AD-1

Statewide Supervision.....AD-1
Communications Systems.....AD-2
Hearings.....AD-2
Legal.....L-1-7
Personnel.....AD-5
Public Records.....AD-3
 Custodial Duties.....AD-3
State Buildings.....AD-3
 Capital Construction.....AD-3
 Housekeeping.....AD-4
 Inventory.....AD-4
 Leases.....AD-4
 Maintenance.....AD-5
 Management Consulting.....AD-9
 Master Plans.....AD-5
 Parking.....AD-5
 Security.....AD-5
Support Services.....AD-6

Adult Foster Care.....SS-12

Affirmative Action.....PER-1,LE-7

Air Quality.....HEA-3,4
 Administration of Controls.....HEA-3
 Regulation and Enforcement.....HEA-4
 Studies and Reports.....HEA-4
 Technical Advice.....HEA-5,HI-14

Aircraft, Service to State Agencies.....HI-22

Aged, Assistance.....SS-4,13

Agriculture
 Products Promotion
 Beef.....AG-1
 Gasohol.....AG-1
 Sheep.....AG-1
 Market Development.....AG-1
 News and Data Collection.....AG-2
 Program Coordination.....AG-3
 State Fair.....AG-3

Agriculture, Department of.....AG-1

Agriculture, Regulation of Activities
 Controls.....AG-3
 Diseases.....AG-3
 Food.....AG-3
 Livestock.....AG-3
 Orchards.....AG-4

	<u>Page</u>
Poultry.....	AG-4
Strays.....	AG-4
Pests.....	AG-4
Predators.....	AG-5
Inspections.....	AG-5
Animals.....	AG-5
Cattle and Horses.....	AG-5
Dairies.....	AG-6
Feeds.....	AG-6
Fertilizer.....	AG-6
Fruits and Vegetables.....	AG-7
Grain.....	AG-7
Plants.....	AG-7
Seeds.....	AG-8
Weights.....	AG-8
Licenses.....	AG-8
Registrations.....	AG-9
Alcohol and Drug Abuse Programs.....	HEA-11
Driving Safety Programs.....	HI-12
Animals	
Disease Control.....	HEA-5
Inspection.....	AG-4
Transportation.....	HI-16
Apprenticeship Programs.....	LE-4
Appropriations	
Centralized Control.....	AD-7
Transfers.....	AD-7
Architects, Registration.....	RA-4,11,24
Arts and Humanities, Council on.....	HE-3
Assessors.....	LA-15
Assistance Programs for the Needy, see Social Services	
Attorney General, Duties.....	L-1-7
Audit	
Centralized for Executive Departments.....	AD-7
Highways.....	HI-22
Institutions.....	IN-2
Performance Audit.....	LEG-3,4
Regulated Business and Individuals.....	RA-12-14
Tax.....	REV-11
Social Services.....	SS-7,8,9

Auditor, State.....LEG-2

Auraria Higher Education Center, see Higher Education

Automobiles--see Motor Vehicles

Automated Data Processing

- Centralized Services for Executive Departments.....AD-1
 - Statewide Planning.....AD-1
 - Statewide Supervision.....AD-1
- Highways.....HI-22
- Local Government.....LA-8
- Revenue Collections.....REV-13

- B -

Bail Bondsmen

- Annual Reports.....RA-12
- Licensure.....RA-5

Banks

- Designation as Depositories.....RA-19
- Liquidations.....RA-23
- Mergers.....RA-23
- Record Examination.....RA-13
- Regulation.....RA-2,8,14,15,19

Barbers and Cosmetologists

- Licensure.....RA-5,12,24

Beef, Promotion.....AG-1

Blind, Assistance to.....SS-1,4

Boilers, Inspections of.....LE-11

Boundry Disputes, County.....NR-25

Budget, State

- Appropriation.....LEG-1,9
- Execution.....OSPB-2
- Fiscal Notes.....OSPB-4
- Higher Education.....HE-5
- Preparation.....OSPB-3,4,LEG-4,5
- Zero-base Budgeting.....OSPB-3,LEG-5

Business Filings and Incorporations
Commercial Filings.....ST-1
Incorporations.....ST-2
 Licensing.....ST-4
 Not for Profit Corporations.....ST-2
 Professional Corporations.....ST-2
 Profit Corporations.....ST-2
Business Promotion.....LG-4, LA-1
Government Regulation.....RA-21
Housing.....LA-7
Minority-owned Businesses.....AD-2,3

- C -

Capital Construction
Standards for State Buildings.....AD-3,4
Higher Education.....HE-4
Cemeteries
Licensure.....RA-3
Certification.....LA-9
Peace Officers.....LA-5
Valuations for Assessment.....LA-5
Child Care Facilities, Licensure.....SS-13
Chiropractors
Licensure.....RA-5,11,25
Professional Service Corporations.....RA-17
Claims
Centralized Processing for State Agencies.....AD-7
Commission on Higher Education.....HE-4
Communications Systems
Centralized Coordination for Executive Branch.....AD-2
Community Mental Health Centers, see Mentally Ill
Compensation Insurance
Fund Maintenance.....LE-2

Coal Mines
 Inspection.....NR-9
 Reclamation.....NR-24

Colleges and Universities, see Higher Education

Colorado State University, see Higher Education

Community Centers
 Developmentally Disabled.....IN-3,4
 Mentally Ill.....IN-4,5

Community Colleges, see Higher Education

Consumer Protection
 Controlled Substances.....HEA-1
 Sanitation and Safety.....HEA-1
 Facilities and Products.....HEA-1
 Food.....HEA-3

Contracts, Centralized Administration for Executive Departments...AD-8

Controlled Substances, Licensure of Manufacturers.....HEA-1

Correctional Facilities
 Inmate Care and Supervision.....CO-1
 Internal Support Services.....CO-5
 Facilities Maintenance.....CO-5
 Financial Affairs.....CO-6
 Management and Supervision.....CO-7
 Personnel Services.....CO-8
 Parole Administration.....CO-2
 Program Development and Administration.....CO-3

Correctional Industries.....CO-4

Corrections, Department of.....CO-1

Credit Unions
 Regulation.....RA-15

Credentialing, Occupations and Professions, see Regulation

Criminal Justice, also see Law Enforcement
 Information Services.....LA-8,9
 Investigations, Thefts of Vehicles.....HI-17

Dairy, Inspections.....AG-6

Dams
Construction Inspections.....NR-9

Data Collection, Agriculture Products.....AG-2

Deaf and the Blind, School for
Supervision.....ED-1

Dental Assistance.....HEA-12,13

Dentists
Licensure.....RA-5,25

Depository, also see Public Records and Records Storage
Records of Public Agencies.....ST-7

Developers, Land
Registration.....RA-3

Developmentally Disabled
Care and Treatment.....IN-1,3
Qualification.....SS-1

Disabled, Assistance.....SS-4

Discrimination.....RA-10,20
Rules and Regulations.....RA-15

Disaster Planning
Intergovernmental Coordination.....MA-1

Disease
Control
Communicable.....HEA-6
Food.....AG-3
Human Illnesses.....HEA-6,12
Livestock.....AG-3
Orchards.....AG-3
Poultry.....AG-3

Driver Licenses, Administration.....REV-9

Drugs
Control of Prescription and Non-prescription.....RA-20

Drug Abuse Programs.....HEA-11

- E -

Economic Development
Long-range Plans.....LA-5

Education, Department of.....ED-1

Education, Elementary and Secondary
Accreditation.....ED-2
Consultative Services to School Districts
Programs.....ED-8
School Administration.....ED-9
Services for Public Libraries
and other Entities.....ED-11
Special Education.....ED-12
Funds Distribution.....ED-2
Intergovernmental Relations.....ED-4
Internal Staffing Services.....ED-5
Program Coordination.....ED-1
Research and Analysis Services
Information Gathering and Publication.....ED-6
Program Evaluation and Approval.....ED-2
Research on Educational Topics.....ED-8
Special Educational Programs.....ED-1,12

Elections
Administration and Enforcement.....ST-5
Initiative and Referenda.....ST-6
Publications.....ST-9

Electricians
Licensure.....RA-5,25

Emergencies
Disaster Planning.....MA-1
Emergency and Security Services.....MA-2
Management and Administration.....MA-2
Property and Equipment Maintenance.....MA-3
Training.....MA-3

Emergency Services.....MA-2

Employees, State
Administrative Coordination.....PER-1
Affirmative Action.....PER-1
Career Development.....PER-1
Classification and Compensation.....PER-1
Consultation.....PER-2

	<u>Page</u>
Internal Support Services.....	PER-3
Oversight.....	PER-4
Recruitment.....	PER-4
Rule and Regulation Implementation.....	PER-5
Training.....	PER-4
Employment Agencies	
Regulation.....	LE-12
Employment Services	
Job Centers.....	LE-5
Migrant Farmworkers.....	LE-3
Training for Employment.....	LE-3
Emissions Control, Regulation.....	HEA-4
Energy Assistance	
Cost Assistance.....	SS-5
Energy Conservation.....	LA-10,14,RA-21
Energy Development.....	NR-11
Enforcement	
Recreational Permits.....	NR-15
Recreational Vehicles.....	NR-15
Revenue Collection.....	REV-6
Water Laws.....	NR-16
Wildlife Laws.....	NR-15
Engineers	
Licensure.....	RA-5
Rules and Regulations.....	RA-17
Environment, Protection	
Air Quality Control.....	HEA-3
Administration of Control Program.....	HEA-3
Regulation and Enforcement.....	HEA-4
Studies and Reports.....	HEA-4
Technical Advice.....	HEA-5
Disease Control.....	HEA-5
Animals.....	HEA-5
Investigation, Study and Regulation.....	HEA-6
Hazardous Waste Management.....	HEA-6
Disposal.....	HEA-6
Regulation.....	HEA-7
Technical Assistant.....	HEA-8
Highway Planning.....	HI-5
Noise Abatement.....	HEA-8

Radiation Control.....HEA-8

Water Quality Control.....HEA-8

 Administration.....HEA-8

 Regulation and Enforcement.....HEA-9

 Studies and Reports.....HEA-10

Environment, Safety.....NR-8

Escheats.....TR-2

Explosives, Safety Regulation.....NR-8

- F -

Federal Grants

 Coordination

 Department of Local Affairs.....LA-1

Feed, Agricultural Product Inspection.....AG-6

Fees, also see Licenses

 Motor Vehicle.....REV-1,2

 Professional and Occupational.....RA-25,26,27,36

 Utilization of Natural Resources.....NR-16

Fertilizer, Inspection.....AG-6

Filings (also see Business Filings)

 Public Officials.....ST-8

Financial Management

 Centralized for Executive Departments.....AD-7

Financial Services, Centralized for Executive Departments

 Accounting.....AD-6

 Appropriations.....AD-7

 Transfers.....AD-7

 Audit.....AD-7

 Claims.....AD-7

 Fiscal Rules.....AD-8

 Purchasing.....AD-8

 Contracts.....AD-8

 Motor Vehicles.....AD-8

 Printing.....AD-8

• Supplies Management.....AD-9

Fines

Regulated Occupations.....RA-2

Fiscal Rules

Promulgation.....AD-8

Food

Assistance Program.....SS-5

Manufacturing.....HEA-3

Sanitation.....HEA-1

Fort Lewis College, see Colleges and Universities

Forests, State

Administration.....NR-24

Fraternal Benefit Societies

Licensure.....RA-3,4

Fruits and Vegetables, Inspection.....AG-7

Funds

Administration of Special Funds.....LA-2

Distribution.....LA-2,4

Elementary and Secondary Education.....ED-2

Trusts and Tax Funds.....TR-1

- G -

Gasohol, Promotion.....GA-1

Geothermal Wells, Regulation.....NR-24

Grains, Inspection.....AG-7

Grants, see Funds

Handicapped, also see Developmentally Disabled

- Mentally.....SS-1,2
- Physically.....SS-1,2
- Public Buildings.....AD-4

Hazardous Materials

- Regulation.....HEA-2
- Training for Accidents.....HEA-2
- Transportation.....RA-16

Hazardous Products, Regulation.....HEA-1

Hazardous Waste Management

- Disposal.....HEA-6
- Radiation Control.....HEA-8
- Regulation.....HEA-7
- Technical Assistance.....HEA-8

Health Care

- Emergency Medical Services.....HEA-14
- Health Facilities Regulation.....HEA-14
- Health Promotion.....HEA-16
- Statistics and Vital Records.....HEA-16
- Support Services for Health Programs.....HEA-17
 - Administrative Services.....HEA-17
 - Laboratory Services.....HEA-17
 - Program Administration.....HEA-18

Health Care Program, Administrative Services.....HEA-17

- Laboratory Services.....HEA-17

Health Care Services, Coordination

- Alcohol and Drug Abuse.....HEA-11
- Community Nursing.....HEA-12
- Family Health Services.....HEA-12
- Infants.....HEA-14

Health, Department of.....HEA-1

Health Facilities, Regulation.....HEA-14,18

Hearings

- Air Pollution.....HEA-3
- Centralized for Executive Branch.....AD-2
- Estate Tax.....LA-7
- Local Government Issues.....LA-6,7
- Liquor Licensing.....REV-5
- Motor Vehicles.....REV-5

Page

Natural Resources.....NR-21
Parole.....CO-3
Property Tax.....LA-6,7
Regulatory Hearings, Companies and Individuals.....RA-8,12
Secretary of State.....ST-8
Taxpayer Protests.....REV-5
Water Quality.....HEA-10

Hearing Aid Dealers
Licensure.....RA-5,11,25

Higher Education
Program Administration

Comprehensive Universities and Colleges: University of Colorado at Colorado Springs, Adams State College, Western State, University of Southern Colorado, Fort Lewis, Mesa, Metropolitan State College.....HE-1

Doctoral Granting Institutions: University of Colorado at Boulder and Denver, Colorado State University, University of Northern Colorado.....HE-2

Specialized Institutions: School of Mines.....HE-3

Two-Year Colleges: Arapahoe, Lamar, Pikes Peak, Trinidad State, Morgan, Otero, Pueblo Community Colleges and Community Colleges of Denver.....HE-3

Governance

Comprehensive Universities and Colleges: Board of Directors-Auraria, Trustees of the Consortium of State Colleges.....HE-7

Doctoral Granting Institutions: Regents of the University of Colorado, Trustees of the University of Northern Colorado, State Board of Agriculture...HE-7,8

Specialized Institutions: School of Mines.....HE-9

Two-Year Colleges: State Board for Community Colleges and Occupational Education.....HE-9

Program Coordination

Capital Construction.....HE-4
Financial Assistance to Students.....HE-5
Institutional Roles.....HE-5

Higher Education, Department of.....HE-1

Highways

Administrative Support

Centralized Services.....HI-22
Aircraft.....HI-22
ADP.....HI-22
Auditing, Budgeting and Accounting.....HI-22
Building Operations.....HI-24
Motor Vehicles.....HI-24
Procurement.....HI-24
Repair.....HI-25
Reproduction.....HI-25
Supplies.....HI-25
Surplus Disposal.....HI-25
Management Operations.....HI-25

Construction and Maintenance

Assistance to Governmental Entities.....HI-1
Hazardous Materials Training.....HI-2
Highway Construction and Maintenance.....HI-6
Administration and Supervision.....HI-6
Construction Planning.....HI-2
Highway Use Control.....HI-8
Policy Direction.....HI-8
Highway Safety Coordination and Promotion.....HI-10,27
Highway and Traffic Studies.....HI-12
Information Generation and Distribution.....HI-14
Map Production.....HI-15
Law Enforcement.....HI-15,16
Criminal Investigation.....HI-17
Protection for Governmental Officials.....HI-17
Transportation Planning.....HI-17

Highways, Department of.....HI-1

History, State

Arts.....HE-3
Catalogue and Display of Artifacts.....HE-4

Hospitals

Regulation and Licensure.....RA-4,20,HEA-14,15

Housing

Discrimination.....RA-10
Research and Evaluation on Housing Needs.....LA-11
Standards.....LA-12,REV-6

Hunting, see Wildlife

Income Tax, see Taxes

Incorporations, Certificates of

Not for Profit.....	ST-2
Professional.....	ST-2
Profit.....	ST-2

Infants, Health Care.....HEA-14,18

Inmate Care and Supervision, Correctional Facilities.....CO-1

Inspections, Agricultural

Animals.....	AG-5
Cattle and Horses.....	AG-5
Dairies.....	AG-6
Feeds.....	AG-6
Fertilizer.....	AG-6
Fruits and Vegetables.....	AG-7
Grain.....	AG-7
Plants.....	AG-7
Seeds.....	AG-8
Weights.....	AG-8

Inspections

Boilers.....	LE-11
Employment Agencies.....	LE-12
Fuels.....	LE-12
Mines.....	NR-9
School Buildings.....	LE-12
Theatrical Agencies.....	LE-12

Institutions, Department of.....IN-1

Insurance.....RA-1,4,8,9,18,20,22,25

Employee (State) Health and Accident Insurance.....	RA-20
Financial Reports.....	RA-13
No-fault Administration.....	RA-20
Premium Taxes.....	RA-19
Regulation.....	RA-1,13

Intergovernmental Relations

Elementary and Secondary Education.....	ED-4
Research Development and Management.....	NR-3

Investigations, see Regulation

Investments, State Treasurer.....TR-2

- J -

Job Centers, see Employment Services

Joint Budget Committee.....LEG-2

Judicial Proceedings
 Regulated Business Activities.....RA-29-31,37-40

Juveniles
 Custody and Care Functions.....IN-1,2,SS-13,14

- L -

Labor
 Dispute Resolution.....LE-4
 Discrimination.....RA-10

Labor and Employment, Department of.....LE-1

Laboratory Services
 Public Health.....HEA-17

Land Reclamation.....NR-13

Land Use
 Hearings.....LA-7
 Regulation.....LA-6
 Technical Assistance.....LA-13

Lands, Public
 Acquisition and Development.....NR-1
 Descriptions, Records.....NR-11
 Hearings on Ownership Claims.....NR-21,23
 Intergovernmental Cooperation for Land Management.....NR-3
 Resource Management.....NR-23

Law, Department of.....LA-1

Law Enforcement
 Assistance to Local Government.....LA-6
 Certification.....LA-5
 Criminal Investigation.....HI-17
 Protection of Officials.....HI-17
 Recreational and Hunting Laws.....NR-15

Page

Research and Evaluation.....LA-11
Technical Assistance.....LA-13,14
Training of Personnel.....LA-1,3,11,15,HI-1,21
Traffic Control.....HI-15

Law-making, see Legislature

Leases

State Buildings.....AD-4

Legal Opinions, Attorney General.....L-1

Legal Services to State Agencies.....L-1,7

Legislative Council.....LEG-5

Legislative Drafting Office.....LEG-8

Legislature

Assists Policy-makers

Fiscal Staff Assistance.....LEG-3

Auditing.....LEG-3

Administrative Duties.....LEG-4

Assists Local Entities.....LEG-4

Budget Formulation.....LEG-5

General Staff Assistance.....LEG-5

Depository for Legislative Records.....LEG-7

Legal Assistance.....LEG-7

Administrative Services.....LEG-9

Publication Services.....LEG-9

Policy-making

Law-making.....LEG-1

Management Functions.....LEG-2

Libraries, State Assistance to.....ED-11

Licenses

Agriculture.....AG-8

Business.....PEV-10,ST-4

Drivers.....REV-9

Liquor.....REV-1

Licensing Hearings.....REV-5

Motor Vehicle.....REV-1,8,9

Motor Vehicle Dealers.....REV-9

Occupations, see Regulation, Business and Occupations

Liquor Law, Enforcement.....REV-4,5

Liquidations
 Banks.....RA-23
 Insurance Companies.....RA-23

Lobbyists Registration.....ST-8

Local Affairs, Department of.....LA-1

Local Government Assistance
 Advisory Services.....LA-1, 3, 13, HI-1, 2
 Appropriation.....LEG-1
 Budget Review.....LA-4
 Business Development.....LA-4, 13
 Certification.....LA-5
 Disaster Planning.....MA-1
 Enforcement.....LA-6
 Executive Management.....LA-1
 Funds Distribution.....LA-4
 Grants and Other Funds.....LA-2
 Hearings.....LA-6
 Estate Tax.....LA-7
 Land Use.....LA-7
 Property Tax.....LA-6
 Housing.....LA-7, 8
 Information Services.....LA-8
 Automated Data Processing.....LA-8
 Criminal Justice.....LA-9
 Energy Conservation.....LA-10
 Local Government Records.....LA-9
 Reports.....LA-10
 Property Values.....LA-11
 Intraagency Coordination and Management.....LA-1
 Land Use.....LA-13, 14, NR-5
 Law Enforcement.....LA-13, 14
 Property Tax.....LA-12, 14
 Recreational Resources.....NR-5
 Research and Evaluation.....LA-11
 Housing.....LA-11
 Law Enforcement.....LA-11, 13
 Rules, Regulations and Standards.....LA-12
 Taxation Questions.....LA-3
 Social Services.....SS-6, 9, 10
 Water Resources.....NR-6
 Weather Modification.....NR-5

- M -

Management Services, for Executive Departments.....AD-9

Map Production.....H1-15,HR-12

Market Development, Agriculture.....AG-1

Medicaid, see Medical Assistance

Medical Assistance for the Needy.....SS-2,3
 Administration.....SS-2,3
 Policy.....SS-2
 Rules and Regulations.....SS-3

Medical Services, Emergency.....HEA-14

Mentally Ill
 State Care and Treatment.....IN-1,4,SS-1

Mergers
 Banks.....RA-23

Mesa College, see Higher Education

Metropolitan State College, see Higher Education

Military Affairs, Department of.....MA-1

Military Forces
 State Coordination.....MA-1-4

Minerals
 Records.....NR-12
 Resource Development.....NR-1,5,16

Mines
 Operations.....NR-7,17,24
 Records.....NR-12
 Safety.....NR-8,9,10,15

Minority Affairs.....AD-2

Mobile Home Dealers
 Licensure.....RA-6

Mortuary Science.....RA-6,17

Motor Clubs
 Licensure.....RA-3,4,9

Motor Vehicles

Accident Reports.....REV-10
 Carrier Regulation.....RA-1,9,14,16,18
 Centralized Control for Executive Departments.....AD-8
 Driver Safety.....REV-10
 Enforcement of Law.....REV-3
 Exhaust Emissions Control.....HEA-4
 Hearings, Law Violations.....REV-5
 Highway Department Vehicles.....HI-24
 License Fees.....REV-1,2,RA-19
 Licensing and Registration.....REV-9,10
 Safety Standard.....RA-14
 State Owned.....AD-8
 Thefts.....HI-17

- N -

National Guard

Management and Administration.....MA-2
 Property and Equipment Maintenance.....MA-3

Natural Resources

Administration and Management
 Data Collection and Reporting.....NR-10
 Energy Development.....NR-11
 Land.....NR-11
 Minerals and Mining.....NR-12
 Water.....NR-14
 Department of Natural Resources.....NR-1
 Enforcement.....NR-15
 Fees, Licenses and Permits.....NR-16
 Minerals.....NR-16
 Mining Operations.....NR-17
 Recreation.....NR-17
 Water Development.....NR-18
 Weather Modification.....NR-19
 Wildlife.....NR-19
 Hearings.....NR-20
 Internal Management and Support Services.....NR-22
 Resource Management.....NR-23
 Land, Minerals and Mining.....NR-23
 Recreation.....NR-25
 Water Development.....NR-26
 Wildlife.....NR-28
 Acquisition and Development.....NR-2

NR-2 Construction and Maintenance.....
 NR-2 Environmental Safety.....
 NR-8 Intergovernmental Cooperation for Resource Management
 NR-3 Federal-State Relations.....
 NR-3 Resource Management.....
 NR-5 State-Local Relations.....
 NR-5 Resource Management.....
 NR-6 Preservation and Protection.....

No-fault Insurance
 Administration.....RA-20
 Noise Abatement.....HEA-8, HI-14

Nursing
 Alternatives for Long Term Care.....SS-3
 Community Health Care Services.....HEA-12
 Licensure.....AR-6, 11
 Veterans Care.....SS-12

Occupations, Licensure, see Regulation
 Oil Inspection.....LE-12
 Optometrists.....RA-6
 Annual Report.....RA-12
 Professional Service Corporations.....RA-17

Parking, State Buildings.....AD-5

Parks
 Development.....NR-5

Parole
 Administration.....CO-2

	<u>Page</u>
Passenger Tramway	
Fees.....	RA-19
Regulation.....	RA-2
Permits, also see Licenses	
Air Quality.....	HEA-4
Mining Operations.....	NR-17
Recreational Activities.....	NR-17
Water Development.....	NR-18
Personnel, Department of.....	PER-1
Personnel, see Employees	
Pests	
Control.....	AG-4
Physical Therapists	
Licensure.....	RA-6
Physicians	
Licensure.....	RA-6
Physically Handicapped, see Handicapped	
Planning	
State	
Disaster.....	MA-1
Employment.....	LE-4
Highways.....	HI-2
Long-range and Short-range.....	OSPB-1
Program Review.....	OSPB-1
Research.....	OSPB-2
Resource Management.....	NR-6
Transportation.....	HI-17
Plants, Inspection.....	AG-7
Plumbers	
Licensure.....	RA-6,17
Pollution Control	
Air.....	HEA-3
Water.....	HEA-11
Printing	
Centralized for Executive Departments.....	AD-8
Prisons, see Correctional Facilities	

Program Administration
Correctional Facilities.....CO-3
Educational, Elementary & Secondary
Coordination.....ED-1
Health.....HEA-18
Special Education.....ED-12

Property Taxation
Appeals Hearings.....LA-6,12
Assists Local Governments.....LA-14,15
Recommendations on Administration & Enforcement.....LA-1,3,9

Psychiatric Technicians
Licensure.....RA-6

Psychologists
Licensure.....RA-6
Professional Service Corporations.....RA-17

Public Buildings, see State Buildings

Public Lands, see Land

Public Records
Custodial Duties.....AD-3

Public Safety
Accident Reports.....REV-10
Driver Safety.....REV-10
Identification Cards.....REV-10

Public Schools, see Education

Public Utilities
Property Values.....LA-11
Regulation.....RA-9,10,16,19,22

Purchasing
Centralized for Executive Departments
Contracts.....AD-8
Local Government Assistance.....LA-14
Motor Vehicles.....AD-8
Printing.....AD-8
Supplies Management.....AD-9

Racing

Regulation

Dogs and Horses.....RA-1,9,11
 Fees.....RA-19
 Operators.....RA-18
 Promotion.....RA-21

Radiation Control.....HEA-8,NR-16

Railroads

Highway Crossings, Inventory.....HI-13
 Regulation.....RA-9,11,17,18

Real Estate Brokers

Annual Reports.....RA-13,24
 Licensure.....RA-5,9,25

Reapportionment.....ST-10,LEG-7

Reciprocity

Occupations.....ED-6,RA-7

Records Storage, also see Depository.....REV-7,ST-7,AD-3,LEG-7

Recreation

Fees, Licenses, Permits.....NR-17,25
 Rules and Regulations.....NR-25

Refugee Assistance.....SS-6

Registrations

Agriculture.....AG-9
 Commercial Business.....ST-1

Regulation

Audits and Reports.....RA-12-14
 Businesses and Occupations
 Abstractors.....RA-5
 Accountants.....RA-3,5
 Adjusters.....RA-7
 Architects.....RA-4,5
 Bail Bondsmen.....RA-5
 Banks.....RA-2
 Barbers and Cosmetologists.....RA-5
 Cemeteries.....RA-3
 Chiropractors.....RA-5
 Dentists.....RA-5
 Electricians.....RA-5

Page

Engineers.....	RA-5
Fraternal Benefit Societies.....	RA-3,4
Hearing Aid Dealers.....	RA-5
Insurance.....	RA-1,2,4
Mobile Home Dealers.....	RA-6
Mortuary Science.....	RA-6
Motor Carriers.....	RA-1,2,3,18
Motor Clubs.....	RA-3,4
Nursing.....	RA-6
Nursing Homes.....	RA-1
Nursing Home Administration.....	RA-6
Optometrists.....	RA-6
Passenger Tramways.....	RA-2
Physical Therapists.....	RA-6
Physicians.....	RA-6
Plumbers.....	RA-6
Psychiatric Technicians.....	RA-6
Psychologists.....	RA-6
Real Estate Brokers.....	RA-5,7
Savings and Loans.....	RA-4
Social Workers.....	RA-6
Subdivisions Developers.....	RA-5
Surveyors.....	RA-5
Veterinarians.....	RA-7
Fines.....	RA-28
Investigations	
Accountants.....	RA-10
Architects.....	RA-11
Banking.....	RA-8
Barbers.....	RA-12
Chiropractors.....	RA-11
Coordination.....	RA-28
Discrimination.....	RA-10
Employment Practices.....	RA-10
Engineers.....	RA-12
Handicapped.....	RA-11
Hearing Aid Dealers.....	RA-11
Housing Practices.....	RA-10
Labor Practices.....	RA-10
Motor Clubs.....	RA-9
Motor Vehicle Carriers.....	RA-9
Nonprofit Hospitals.....	RA-9
Nurses.....	RA-11
Public Utilities.....	RA-9,10
Racing.....	RA-9-11
Railroads.....	RA-9-11
Real Estate.....	RA-9
Savings and Loans.....	RA-10
Subdivision Developers.....	RA-9

Veterinarians.....RA-12

Judicial Proceedings.....RA-29

Orders.....RA-31

Revocations and Suspensions.....RA-32-36, 40-44

Rules and Regulations.....RA-14,27

Regulatory Agencies.....RA-1

Reports

 Natural Resources.....NR-22

 Secretary of State.....ST-9

 Treasury.....TR-1

Revenue, Department of.....REV-1

Revenue Estimates.....OSP-2,REV-8,LEG-4,5

Revisor of Statutes.....LEG-2

Rules and Regulations

 Legislative Review.....LEG-7

 Licensed Businesses and Individuals.....RA-14

 Social Services.....SS-6,7

 Wildlife.....NR-24

Safety, Inspection

 Carnivals, Amusement Parks, School Buildings.....LE-12

Safety, Highway.....HI-10

Salaries, State Officials--Study.....LEG-2

Sanitation

 Facilities and Products.....HEA-1,2

 Food.....HEA-3

 Water for Drinking.....HEA-9

Savings and Loans

 Regulation.....RA-4,10,17

School Buses, Safety Inspection.....HI-11

School of Mines, see Higher Education

Securities Business
Regulation.....RA-2

Security, State Building.....AD-5
Internal.....MA-2

Seeds, Inspection.....AG-8

Service of Process, Secretary of State.....ST-10

Sheep Promotion.....AG-1

Social Services, Department of.....SS-1

Social Services, State
Financial Services
Aid to Families with Dependent Children (AFDC).....SS-4
Work Incentive.....SS-4
Assistance to the Aged, Blind or Disabled.....SS-4
Food Assistance Programs.....SS-5
Low Income Energy Cost Assistance.....SS-5
Refugee Assistance.....SS-6
Adults.....SS-12
Aging.....SS-13
Licensure of Childcare Facilities.....SS-13
Youth.....SS-13

Social Workers
Regulations.....RA-6

Soil Conservation
Financing.....NR-7,25
Hearings on Formation.....NR-21
Intergovernmental Relations.....NR-5
Withdrawal.....NR-2,25

State Board of Agriculture, see Higher Education

State Buildings.....AD-3
Capital Construction Standards.....AD-3
Groundskeeping.....AD-5
Housekeeping and Maintenance.....AD-4,5,HI-24,LE-5
Inventory of Property.....AD-4
Leases.....AD-4
Life-cycle Cost Analysis.....AD-5
Maintenance.....AD-5
Master Plans.....AD-5
Parking.....AD-5
Security.....AD-5

	<u>Page</u>
State, Department of.....	ST-1
State Employees	
Centralized Administrative Services.....	AD-5
State Fair.....	AG-3
State Historical Society, see Higher Education	
State Lands, see Lands	
State Patrol, see Law Enforcement	
State Planning and Budgeting, Department of.....	OSPB-1
State Property	
Exchange.....	NR-4
Inventory.....	AD-4, NR-12
Rights-of-way.....	NR-3
Statistics and Vital Records	
Health.....	HE-16
Surveyors	
Licensure.....	RA-5
Supplies	
Centralized Management.....	AD-9

- T -

Taxes	
Audit.....	REV-11
Collection.....	REV-11,12
Excise Tax.....	REV-11
Income Tax.....	REV-11
Inheritance, Gift, and Estate Tax.....	REV-11
Motor Vehicle.....	REV-11
Other.....	REV-12
Sales and Use.....	REV-12
Processing.....	REV-12
Automated Data Processing.....	REV-13
Delinquencies.....	REV-13
Penalty Assessments.....	REV-14
Printing and Mailing.....	REV-14
Receipt Process.....	REV-12

Page

Records.....REV-7
Reporting.....REV-14
Taxpayer Protests.....REV-5
Taxpayer Assistance.....REV-15

Technical Assistance, Local Government
Community Development.....LA-13
Land Use.....LA-13
Law Enforcement.....LA-13
Other Local Government Operations.....LA-14
Property Taxation.....LA-14

Tourism
Technical Assistance to Communities.....LA-13

Traffic
Safety.....HI-11,15,16
Studies.....HI-12,13

Trademark Registration.....ST-1

Training, Local Government
Assessors.....LA-15
Law Enforcement.....LA-15

Training, Military.....MA-3

Transportation Planning.....HI-17

Treasury, Department of.....TR-1

Trinidad State College, see Higher Education

Trucks
Size and weight limitations.....REV-4

Tuition Review, Higher Education.....HE-5

- U -

Unemployment Insurance
Administration.....LE-4-8,10
Claims Review and Adjudication.....LE-9

Unemployment Services
Administration.....LE-4,5,6,7,8

Universities and Colleges, see Higher Education

- V -

Veterans Affairs

- Inter-agency Service Coordination.....LE-3
- Nursing Homes.....SS-11,12
- Services.....SS-11

Veterinarians

- Regulation.....RA-7,12

Vocational Rehabilitation

- Blind.....SS-1
- Injured.....SS-2
- Physically and Mentally Handicapped.....SS-1

- W -

Water

- Compacts.....NR-16
- Construction and Maintenance.....NR-2
- Data Collection and Reporting.....NR-14
- Development.....NR-1,18,26
- Fees, Licenses, Permits.....NR-17
- Hearings.....NR-21
- Intergovernmental Cooperation.....NR-3
- Preservation and Protection.....NR-2,8,28
- Quality Control.....HEA-8
 - Administration.....HEA-8
 - Regulation and Enforcement.....HEA-9
 - Studies and Reports.....HEA-10

Weather Modification

- Fees, Licenses, Permits.....NR-19
- Hearings.....NR-20
- Intergovernmental Relations.....NR-5
- Research.....NR-10

Weights Inspection.....AG-8

Wildlife, Hunting
Fees, Licenses, Permits.....NR-19
Game Damage.....NR-28
Information.....NR-10
Law Enforcement.....NR-15
Preservation and Protection.....NR-6,29

Work Incentive Programs.....SS-4

Workmen's Compensation.....SS-2
Claims Processing.....LE-8
Claims Review and Adjudication.....LE-9
General Administration.....LE-10,11