

**RIVINT-AN IMPROVED CODE FOR SIMULATING
SURFACE/GROUNDWATER INTERACTIONS WITH
MODFLOW**

by

Judith Schenk and Eileen Poeter



Colorado Water

Resources Research Institute

Completion Report No. 155

**Colorado
State
University**

RIVINT - AN IMPROVED CODE FOR SIMULATING SURFACE/GROUNDWATER INTERACTIONS WITH MODFLOW

Judith Schenk and Dr. Eileen Poeter

Department of Geological Engineering
Colorado School of Mines
Golden, CO 80401

March 1990

Grant No. 14-08-0001-1551
Project No. 08

The activities on which this report is based were financed in part by the U.S. Department of Interior, Geological Survey, through the Colorado State Water Resources Research Institute. The contents of this publication do not necessarily reflect the views and policies of the U.S. Department of the Interior, nor does mention of trade names or commercial products constitute their endorsement by the United States Government.

COLORADO WATER RESOURCES RESEARCH INSTITUTE
Colorado State University
Fort Collins, Colorado 80523

Neil S. Grigg, Director

TABLE OF CONTENTS

ABSTRACT	1
INTRODUCTION	1
PART I RIVINT THEORY AND USERS MANUAL	3
OVERVIEW OF PROGRAM SEQUENCE	3
RIVINT CODE	3
PARAMETER INPUT	5
COMPUTATION OF RIVER AND ALLUVIUM CONDUCTANCE AND SEEPAGE RATES	16
CALCULATION OF ENERGY GRADIENT OF RIVER AND ALLUVIUM	35
MASS BALANCE OF RIVER FLOW	39
RIVER DEPTH CALCULATION	40
MASS BALANCE OF FLOW IN ALLUVIUM	45
OUTPUT	48
PART II PRELIMINARY RIVINT APPLICATION	49
APPLICATION OF RIVINT TO A PRELIMINARY MODEL OF THE DENVER BASIN	49
CONCEPTUAL MODEL	50
MATERIAL PROPERTIES	60
BOUNDARY CONDITIONS	75
INITIAL CONDITION	83
STRESSES TO THE SYSTEM	83
FUTURE STUDIES	97
SUMMARY	97
REFERENCES	98
APPENDIX A - Input Formats	
APPENDIX B - RIVINT Code	
APPENDIX C - Instructions for running Denver Basin Files	

List of Figures

Figure 1. RIVINT Subroutine Functions	4
Figure 2. Schematic of river delineation on finite difference grid	6
Figure 3. River channel geometry and parameters	9
Figure 4. Horizontal seepage distance between river and grid cell	10
Figure 5. Vertical seepage distance between river and grid cell	11
Figure 6. Alluvium parameters	13
Figure 7. Length of river and alluvial reaches	14
Figure 8. Horizontal seepage distance between alluvium and grid cell	15
Figure 9. Vertical seepage distance between alluvium and grid cell	17
Figure 10. Area of river seepage	19
Figure 11. Conditions of river seepage	20
Figure 12. Equivalent hydraulic conductivity between river and grid cell	21
Figure 13. Conductance and seepage for a gaining river	22
Figure 14. Conductance and seepage for a losing river under fully saturated conditions	24
Figure 15. Conductance and seepage for a perched river	25
Figure 16. Conditions of alluvium/grid cell seepage	26
Figure 17. Equivalent hydraulic conductivity between alluvium and grid cell	28
Figure 18. Conductance and seepage between saturated alluvium and grid cell	29
Figure 19. Conductance and seepage between alluvium and unsaturated grid cell	30
Figure 20. Conductance and seepage between dry alluvium and saturated grid cell	31
Figure 21. Equivalent hydraulic conductivity and seepage between gaining river and alluvium	32
Figure 22. Equivalent hydraulic conductivity and seepage between losing river and alluvium	33
Figure 23. Seepage form a perched river	34
Figure 24. Gradient in a river reach	36
Figure 25. Gradient in an alluvial reach	38
Figure 26. Mass balance in a river reach	41
Figure 27. Simplified Manning Equation	43
Figure 28. Manning's Equation for a trapezoidal channel	44
Figure 29. Discharge through alluvium	47
Figure 30. Denver Basin Location	51
Figure 31. Distribution of precipitation	52
Figure 32. Principal aquifers in the Denver Basin	53
Figure 33. Schematic cross sections of the Denver Basin	54
Figure 34. Measured 1978 potentiometric surface in the Dawson aquifer	55
Figure 35. Measured 1978 potentiometric surface in the Denver aquifer	56
Figure 36. Measured 1978 potentiometric surface in the Arapahoe aquifer	57
Figure 37. Measured 1978 potentiometric surface in the Laramie-Fox Hills aquifer	58
Figure 38. Measured 1978 potentiometric surface in the Alluvial aquifers	59
Figure 39. Stream gage stations utilized in this study	61
Figure 40. Finite difference grid	62
Figure 41. Geohydrologic features of grid area	63
Figure 42. Configuration of alluvium simulated as grid cells across formation contacts	65
Figure 43. Hydraulic conductivity of the Dawson aquifer	66
Figure 44. Hydraulic conductivity of the Alluvial aquifers	67
Figure 45. Transmissivities of the Denver aquifer	68
Figure 46. Transmissivities of the Arapahoe aquifer	69
Figure 47. Transmissivities of the Laramie-Fox Hills aquifer	70
Figure 48. Storage Coefficient of the Dawson aquifer	71
Figure 49. Storage Coefficient of the Denver aquifer	72
Figure 50. Storage Coefficient of the Arapahoe aquifer	73
Figure 51. Storage Coefficient of the Laramie-Fox Hills aquifer	74
Figure 52. Vertical conductance between the Dawson and Denver aquifers	76
Figure 53. Vertical conductance between the Denver and Arapahoe aquifers	77
Figure 54. Vertical conductance between the Arapahoe and Laramie-Fox Hills aquifers	78
Figure 55. Recharge applied to the Basin	79
Figure 56. Locations of fixed head grid cells	80

Figure 57. River reaches simulated in the model and external inflows applied to the model	82
Figure 58. Simulated "pristine" potentiometric surface of the Dawson aquifer	84
Figure 59. Simulated "pristine" potentiometric surface of the Denver aquifer	85
Figure 60. Simulated "pristine" potentiometric surface of the Arapahoe aquifer	86
Figure 61. Simulated "pristine" potentiometric surface of the Laramie-Fox Hills aquifer	87
Figure 62. Simulated "pristine" potentiometric surface of the Alluvial aquifers	88
Figure 63. Simulated Pumping in the Dawson aquifer	89
Figure 64. Simulated Pumping in the Denver aquifer	90
Figure 65. Simulated Pumping in the Arapahoe aquifer	91
Figure 66. Simulated Pumping in the Laramie-Fox Hills aquifer	92
Figure 67. Simulated potentiometric surface of the Dawson aquifer after 40 years of pumping	93
Figure 68. Simulated potentiometric surface of the Denver aquifer after 40 years of pumping	94
Figure 69. Simulated potentiometric surface of the Arapahoe aquifer after 40 years of pumping	95
Figure 70. Simulated potentiometric surface of the Laramie-Fox Hills after 40 years of pumping	96

ABSTRACT

RIVINT (short for RIVER INTERactions) was developed for simulation of groundwater systems where river flow can be significantly affected by stresses imposed on the groundwater system. Most available groundwater computer codes simulate river flow by assigning a river stage which remains constant throughout the computer simulation and/or allow for only one or two conditions of seepage between river and aquifer. RIVINT will simulate a variable river stage and will calculate seepage based on the conditions that exist between the river and aquifer during a simulation. RIVINT can be used to predict how rivers or rivers and their alluvium, will be affected by stresses on the groundwater system such as pumping of ground water. RIVINT interfaces with the U.S.G.S. three-dimensional groundwater flow code (MODFLOW). The code is currently designed for steady state or transient simulations if none of the river reaches includes alluvium, and transient simulations if alluvium is simulated with river reaches.

This report describes the features of RIVINT, serves as a users manual for the code, and presents a preliminary simulation of the Denver Basin using RIVINT. Preliminary simulation of the Denver Basin is based on the model developed by Banta (1989). Banta's grid, material properties, and boundary conditions were used as a basis for this simulation and alluvium and rivers were added to the grid. Only minor modifications of Banta's data set were required to obtain an operable model of the basin once the rivers were simulated in more detail. Numerous problems were encountered with calibration of the model and the model should be improved and recalibrated before application to water management problems in the Denver Basin. Details of these problems are discussed later in this report. In general the solution to these problems includes: 1) closer calibration of the bedrock flow system originally presented by Banta (1989) because river flows are substantially impacted by discrepancies between bedrock and field heads which are greater than 300 feet in some areas, 2) refinement of the original grid to allow more detailed simulation of river areas; 3) field measurement of parameters pertinent to surface water-groundwater interactions (e.g. channel geometry, river bed properties, and streamflows); and 4) thorough calibration of the model given the refined grid and improved data.

Magnetic disks included with this document provide the MODFLOW code, a new MODMAIN module, the RIVINT module, and the data files for the preliminary simulation of the Denver Basin.

INTRODUCTION

Improved estimation of reduction or increase in river flow resulting from stresses on groundwater systems is of pressing concern and a computer code that better simulates more realistic conditions of seepage between the rivers and aquifer is needed for projects where the primary objective is monitoring variation in stream flow in response to groundwater stresses. If river simulation does not reflect changes in river flow, an overestimation of water available for appropriation may result. RIVINT (short for RIVER INTERactions) was developed for simulation of groundwater systems where river flow can be significantly affected by stresses imposed on the groundwater system. Most available groundwater computer codes simulate river flow by assigning a river stage which remains constant throughout the computer simulation and/or allow for only one or two conditions of seepage between river and aquifer. RIVINT will simulate a variable river stage and will calculate seepage based on the conditions that exist between the river and aquifer during a simulation.

"RIVINT" is a computer code that simulates surface water-groundwater interactions. RIVINT can be used to predict how rivers or rivers and their alluvium, will be affected by stresses on the groundwater system such as pumping of ground water. RIVINT interfaces with the U.S.G.S. three-dimensional groundwater flow code (MODFLOW). The code is currently designed for steady state or transient simulations if none of the river reaches includes alluvium, and transient simulations if alluvium is simulated with river reaches. RIVINT is based on previous work by Kraeger-Rovey (1975).

Rivers are simulated in the model using Manning's equation for open channel flow, allowing for a variable river stage simulation. RIVINT offers the option of modeling river reaches with or without alluvium. Seepage between river and alluvium, between the alluvium and bedrock, or between the river and groundwater system (if no alluvium is simulated), is calculated using Darcy's Law for flow in a porous media.

River discharge is calculated based on mass balance of flow in the river. River stage is calculated based on the river discharge and Manning's equation for open channel flow. The relationship between head in the underlying aquifer, river stage, and conditions of the river bed determine conditions of seepage between a river and the underlying aquifer. Head in the alluvial aquifer is calculated based on mass balance of flow in the alluvium, and the change in storage over a specified period of time. Head in the alluvial and bedrock aquifer determine the conditions of seepage between the alluvium and bedrock.

A homogeneous reach of river, or river and alluvium, is associated with each grid cell in the groundwater flow model that is overlain by a river. The river reach is located by the layer, row and column which it occupies in the groundwater model. A groundwater grid cell may contain more than one river reach. Parameters to describe the river include, initial river stage, river bottom elevation, channel geometry, Manning's roughness coefficient, and length of the reach. Horizontal seepage distance (seepage distance is the denominator in a gradient calculation) between the river and groundwater aquifer may be entered for reaches which do not include alluvium. If a horizontal seepage distance is not entered, RIVINT will calculate a vertical seepage distance between the river and aquifer. Silt layer vertical hydraulic conductivity and thickness for a losing or gaining river may be included if a silt layer exists on the river bed. Negative pressure may prevail at the base of the silt layer if materials below the silt are unsaturated, therefore the user has the option of entering an air entry pressure; the default is zero. Gains and losses to the river from diversion, return flow, precipitation, evaporation or river flow from outside the modeled area can be included.

Parameters to describe the alluvium include, initial head in the alluvium, geometry, length, horizontal hydraulic conductivity, specific yield, and horizontal seepage distance for seepage between the alluvium and bedrock aquifer. RIVINT will calculate a vertical seepage distance between the alluvium and bedrock aquifer if a horizontal seepage distance is not entered. Gains and losses to the alluvium from recharge, evapotranspiration, pumping or injection and alluvium seepage entering the model from outside the model area can be included.

Output for reaches containing only rivers consists of river discharge, stage and seepage rate between the river and groundwater aquifer. Output for reaches simulating river and alluvium consists of river discharge, river stage, seepage rate between the river and alluvium, head in the alluvium, and seepage rate between the alluvium and groundwater aquifer.

This report describes the features of RIVINT, serves as a users manual for the code, and presents a preliminary simulation of the Denver Basin using RIVINT. Preliminary simulation of the Denver Basin is based on the model developed by Banta (1989). Banta's grid, material properties, and boundary conditions were used as a basis for this simulation and alluvium and rivers were added to the grid. Only minor modifications of Banta's data set were required to obtain an operable model of the basin once the rivers were simulated in more detail. Numerous problems were encountered with calibration of the model and an improved model should be developed and calibrated before application to water management problems in the Denver Basin. Details of these problems are discussed later in this report. In general the solution to these problems includes: 1) closer calibration of the bedrock flow system originally presented by Banta (1989) because river flows are substantially impacted by discrepancies between bedrock and field heads which in some areas are greater than 300 feet, 2) refinement of the original grid to allow more detailed simulation of river areas; 3) field measurement of parameters pertinent to surface water-groundwater interactions (e.g. channel geometry, river bed properties, and streamflows); and 4) thorough calibration of the model given the refined grid and improved data.

Magnetic disks included with this document provide the MODFLOW code, a new MODMAIN module which dimension the arrays large enough to simulate the Denver Basin, the RIVINT module, and the data files for the preliminary simulation of the Denver Basin. For this study the code was compiled both on a 386PC using NDP Fortran, which allows code to extend beyond the typical 640K memory limit of PC's, and on an IBM AIX RS 6000 work station. An executable version of the code is included for standard PC's, but this version of the code is not large enough to run the Denver Basin model. To run the Denver Basin model, redimension the X array in MODMAIN to 800000 and use a compiler that can cope with code larger than 640K. Use of the work station was advantageous with regard to speed of computation and accommodation of large output files for transient simulations, as well as ability to multi-task.

PART I RIVINT THEORY AND USERS MANUAL

OVERVIEW OF PROGRAM SEQUENCE

Based on the initial heads in the river, alluvium, and bedrock of each grid cell, the condition of seepage between river, alluvium, and bedrock are established so that the appropriate equations for calculating conductance and seepage will be utilized. Heads in the river and alluvial reaches are used to calculate gradient for flow along the axis of the river and alluvium. Seepage is calculated between all river, alluvium, and bedrock interfaces. Flow is computed between consecutive river reaches and between consecutive alluvium reaches. The possible conditions and associated equations are discussed later. Net seepage that occurs within each river reach, alluvium reach, and grid cell over each time step is calculated. New heads for the next time step are calculated as follows. Discharge in each river reach is determined by checking mass balance of flow in each reach. Head in the river is calculated in an iterative manner using Manning's equation for open channel flow. Head in the alluvium is calculated based on the change in storage, and head in the grid cells are calculated by MODFLOW in the same way they have always been calculated. Mass balance is checked for the river, alluvium, and the grid cell system. If the system is exceptionally dynamic, large mass imbalances will indicate that the user should rerun the simulation with smaller time steps.

Net discharge in the river is calculated by summing flows into and out of the river including: seepage between the river and underlying grid cell or alluvium, if present; flow into the reach from upstream reaches, and additional flows input by the user such as river diversions, return flows, precipitation, or evaporation. River depth (and hence stage) is calculated using an iteration loop. The newly calculated river flow is used in a simplified Manning's equation to estimate a new depth. The estimated depth is input into the Manning's formula for open channel flow in a trapezoidal channel to calculate an estimated discharge. If the estimated discharge is close to (based on a user specified tolerance) the calculated discharge, the loop is exited. If the river flow is too low or too high, the depth is increased or decreased according to a value either set by the user or defaulted to a set value in the program. A limiting number of iterations in the loop is either set by the user or defaulted in the program.

Net seepage in the alluvial reaches is the sum of: recharge and evapotranspiration, if the user chooses to use these options; pumping and injection; and flow entering the alluvium from upstream alluvium reach(es), and the flow leaving the alluvial reach. A new head in the alluvium is calculated by the equation:

$$\text{New Head in Alluvium} = ((\text{net flow} \times \text{specific yield} \times \text{length of time step}) / \text{area of seepage}) + \text{old head in alluvium}$$

After the new heads for the next time step are established, the simulation moves forward in time by repeating the process presented in this section.

RIVINT CODE

Subroutines in RIVINT are designed to simply replace the MODFLOW river subroutines and are named analogously. Brief descriptions of the RIVINT module subroutines are presented in Figure 1. Two options are available with RIVINT. The first option allows for all river reaches to be simulated without alluvium (either no alluvium is present or grid cells are used to represent alluvium). The second option allows for some or all of the river reaches to be simulated as rivers and associated alluvium.

The first subroutine allocates array storage and sets flag for print and computational options. Parameter information is read in the second subroutine. Conductance terms are calculated in the third subroutine and returned to the main program to be used in the calculation of head in the grid cell.

RIVINT Subroutines**SUBROUTINE RINT1AL**

Allocate array storage for rivers
Set flags for print options
Identify if river reaches may contain alluvium

SUBROUTINE RINT1RP

Read river parameters
Read alluvium parameters for reaches containing alluvium
Print parameter information in output file

SUBROUTINE RINT1FM

Calculate conductance between river and groundwater aquifer
for reaches that contain alluvium:
Calculate conductance between alluvium and groundwater aquifer

SUBROUTINE RINT1BD

Calculate energy gradient in river reaches and alluvium reaches
Calculate river discharge and stage if reach contains alluvium,
Calculate seepage between river and alluvium
Calculate head in alluvium if reach contains alluvium
Calculate volumetric budget of river reaches

Figure 1. RIVINT Subroutine Functions

Volumetric budget is calculated along with energy gradients of rivers and alluvium, seepage rates, river discharge, stage, and head in the alluvium in the fourth subroutine.

The user must specify the time units used in the simulation. This is identified by the variable "ITMUNI" in the MODFLOW basic module input. The time unit is used in the calculation of river flow. The seepage rate between the river and adjoining aquifer is calculated in the time units specified by ITMUNI. River discharge is reported in cubic feet per second (cfs) or cubic meters per second (cms). Volumetric gain/loss of river flow from seepage between river and adjoining aquifer are calculated each time step and is converted to cfs or cms by dividing by the appropriate number of seconds. For example, if time units are designated as days, ITMUNI is equal to 4, and the value of seepage between the river and the alluvium will be divided by 86,400 seconds to convert the value to cfs or cms. The time unit assignment is as follows:

ITMUNI	Time unit
1	seconds
2	minutes
3	hours
4	days
5	years

A value of ITMUNI less than one or greater than five will result in an error message and program termination.

PARAMETER INPUT

Parameter input can be divided into four categories: 1) river reach information; 2) grid cell information; 3) river channel geometry and river flows; and 4) alluvium geometry and alluvial fluxes if alluvium is included as part of the river reach.

River Reach Input

Rivers are modeled by discretizing the rivers into reaches. Generally the river will be segmented according to the groundwater model grid (Figure 2). Each river reach is identified by its reach number. The river reach location is determined by assigning a layer number, K, row number, I, and column number, J, which is consistent with its location in the groundwater model grid. Reach #1 in Figure 2 has the location K=1, I=3, and J=1. The river reaches must be numbered so that upstream reaches have lower numbers than downstream reaches. The program is designed so that any one river reach can have up to three upstream reaches and one downstream reach associated with it. Downstream river reaches are identified by the variable, LDN. Reach #1 has a downstream reach, LDN=2 in Figure 2. The upstream reach number of a river reach is identified by the variables LUP1, LUP2, and LUP3. These upstream reaches may represent the upper reach of the river, a tributary reach, or a man made ditch or channel. There are no upstream reaches for river reaches #1, #3, #5 and #7 in Figure 2. River reach #2 has one upstream reach, L=1. Therefore, for river reach L=2, LUP1=1. River reach #4 has two upstream reaches, LUP1=2, and LUP2=3. Reach #7 does not have an upstream or downstream reach. Values are entered in the input file only if upstream or downstream reach assignments need to be made. If shallower layers of the model are absent in places, reaches can be located in deeper layers of the model (reach #6, Figure 2).

Input format is described in Appendix A.

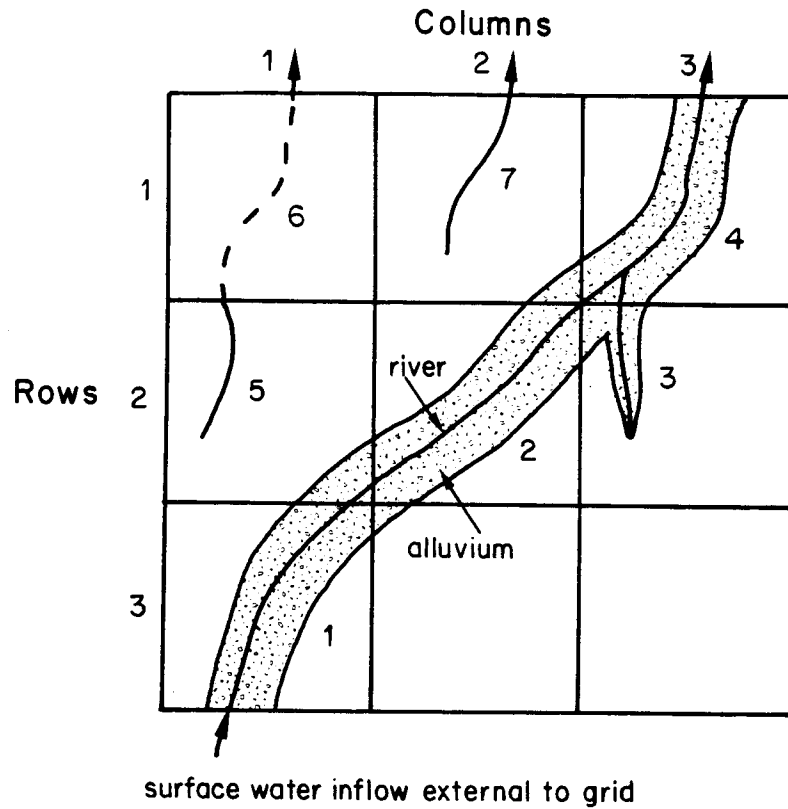

Reach	Layer	Row	Column	Upstream Reach(es)	Downstream Reach
1	1	3	1	—	2
2	1	2	2	1	4
3	1	2	3	—	4
4	1	1	3	2,3	—
5	1	2	1	—	—
6	2	1	2	—	—
7	1	1	2	—	—

Figure 2. Schematic of river delineation on finite difference grid

River Reach Input Variables

MXRIVR	- maximum number of river reaches
IRIVCB	- a flag and a unit number
IRVTYP	- specifies if none of river reaches contain alluvium
ITMP	- number of river reaches to be used in a stress period
ISI	- flag for english or metric units
DTOLD	- tolerance for depth calculation [percent] (optional)
ITRD	- number of allowable iterations for depth loop (optional)
K	- layer number of reach location
I	- row number of reach location
J	- column number of reach location
LDN	- downstream reach number
LUP1	- upstream reach number (up to three upstream reaches; LUP2, LUP3)
NOAL	- flag to specify if reach includes alluvium (enter only if IRVTYP is greater than zero)

MXRIVR is the maximum number of river reaches that are used in any stress period.

IRIVCB is the unit number to which cell-by-cell flow terms will be saved if it is greater than zero, and when ICBCFL is set in the output control file in MODFLOW. Cell-by-cell flow terms will be printed if IRIVCB is less than zero. If IRIVCB is equal to zero, cell-by-cell flow terms will not be printed or recorded.

ITMP specifies how many river reaches are used in a stress period. A value less than zero indicates that the information from the last stress period will be used. ITMP is equal to MXRIVR for steady state simulations.

IRVTYP specifies if alluvium is to be included as part of the river reach. If IRVTYP is equal to zero, none of the river reaches will include alluvium. If IRVTYP is greater than zero, some or all of the reaches may include alluvium.

English units are specified by entering a value of 0 for ISI, and metric units are specified by entering a value of greater than zero. The Manning coefficient will be set to 1.49 if english units are specified, or 1.0 for metric units. Use of the Manning equation for open channel flow require that units of length be in feet or meters.

DTOLD and ITRD are used in the calculation of new depth in the river. The new river depth is calculated using an iterative loop. DTOLD determines how accurate the river depth calculation must be before the loop is exited and is entered as a decimal. ITRD is the maximum number of iterations in the river depth loop. A detailed explanation is included in the section on river depth calculation later in this report.

The variable NOAL specifies whether a reach includes alluvium. NOAL is used only if IRVTYP is greater than zero specifying that river reaches may include alluvium. NOAL is less than or equal to zero if the reach includes alluvium, and is greater than zero if the reach does not include alluvium.

Grid Cell Input

MODFLOW offers four alternative layer types. Depending on the layer type, transmissivities may be entered instead of hydraulic conductivity, and the bottom elevation of the layer is not always entered. Both of these parameters are needed in the RIVINT module if a layer is associated with river reaches, and must be entered in the river input.

Grid Cell Input Variables

BHY - hydraulic conductivity of the underlying grid cell
 BBOT - bottom elevation of the underlying grid cell

River Channel Geometry and Flux Input

The river channel (Figure 3) is used in the calculation of river depth, and in the calculation of seepage between the river and the underlying aquifer. The initial river stage, HRIV, should be a good estimation of the stage of baseflow in the river reach. Field measurements should be made to determine the channel geometry. If the channel geometry is irregular, an equivalent channel geometry should be estimated that will calculate the correct river flow using Manning's equation.

Vertical hydraulic conductivity, SHY, and thickness, THS, of a silt layer can be included in the input data. However, if a silt layer is not present, and these values are entered as zeros, the value of SHY will default to the hydraulic conductivity value of the underlying aquifer and seepage thickness will be calculated from grid cell and river bottom elevation. The user may specify that the parameters describing the silt layer under gaining conditions, SGHY and THSG, are different than those under losing conditions. In particular, the silt layer may be thinner, or may not be present in a gaining river. Three options are available for silt layer parameters in a gaining river: 1) different parameter values may be entered for vertical hydraulic conductivity of the silt and/or silt layer thickness for losing and gaining conditions, 2) a negative number may be entered for SGHY and THSG and the silt layer parameters for a gaining river will default to the parameters of a losing river, or 3) if zeros are input for SGHY and THSG, seepage calculations are conducted assuming no silt layer is present on the river bed under gaining conditions in the river. Negative pressure may prevail at the base of the silt layer if materials below the silt are unsaturated. This is entered as the variable HNEG, and is entered as negative value.

Length of the river reach should reflect the sinuosity of the river within the grid cell, and should be an estimation of actual river length. Energy gradient of the river, RSLP, is entered only for river reaches which do not have a downstream or an upstream river reach. Reach #7 in Figure 2 is an example of this type of reach. If a value is not entered for a reach for which there is no upstream and downstream river reach, an error message will be printed and the program terminated. Energy gradient is calculated for river reaches by the RIVINT program for all other river reaches in the fourth subroutine.

When alluvium is not present, a horizontal seepage distance, RSPDST, (the denominator of a gradient calculation) must be used to calculate the gradient for seepage between the grid cell and the river. If the user does not enter a value for seepage distance the program will calculate seepage distance assuming vertical seepage. The user must decide which calculation is most appropriate for the hydrologic system being modeled. Figure 4 illustrates possible horizontal seepage distance estimations based on the position of the river reach in the grid cell. If the river reach is centered in a square grid cell, the seepage distance would be half the distance between the river and the edge of the grid cell, or approximately 1/4 the distance of the grid cell (Figures 4a and 4b). This distance is based on the average head in the grid cell. In reality, the head in the grid cell would be lowest near the river in the case of a losing river, and highest at the boundary. Therefore, the average head in the grid cell would be 1/2 the distance from the center to the edge. Figure 4c illustrates special situations in which the user will have to make a reasonable estimation of horizontal seepage distance based on the hydrogeologic system being simulated.

Vertical seepage distance will be calculated by the program if the user does not enter a value for RSPDST. The default seepage distance is calculated as 1/2 the distance between the river bottom and the bottom of the bedrock (Figure 5a). If a silt layer is included, this distance is 1/2 the distance between the river bottom and the bottom of the bedrock plus the thickness of the silt layer (Figure 5b). If alluvium is included in the river reach, a vertical seepage distance is automatically calculated by the program, and it is not necessary to enter a value for RSPDST.

River Channel Cross-section

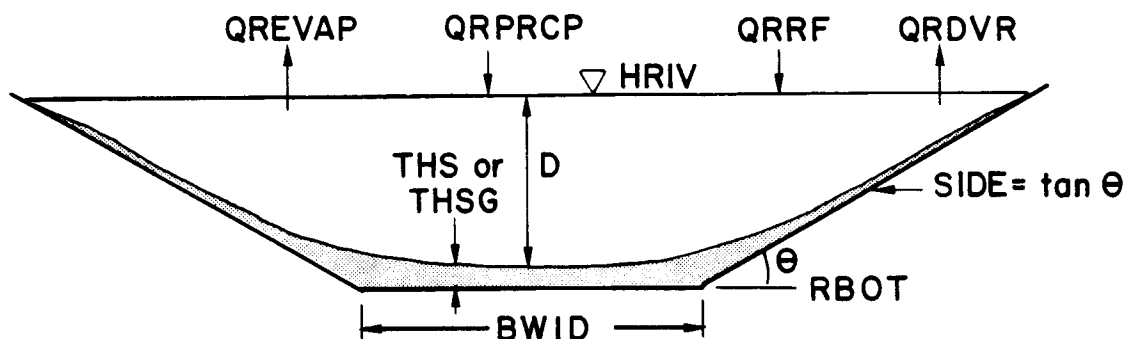

- HRIV - Elevation of surface of river [L]
 - D - Depth of river [L]
 - RBOT - Elevation of river channel bottom [L]
 - BWID - Bottom width of channel [L]
 - SIDE - Slope of the side of the channel = $\tan \theta$ [L/L]
 - AN - Manning roughness coefficient []
 - * SHY - Vertical hydraulic conductivity of silt layer [L/T]
 - * THS - Thickness of silt layer [L]
 - * SGHY - Vertical hydraulic conductivity of silt layer - gaining river [L/T]
 - * THSG - Thickness of silt layer - gaining river [L]
 - * QRDVR - River diversions [L³/T]
 - * QRRF - Return flows [L³/T]
 - * RPRCP - Precipitation falling on river [L/T]
 - * REVAP - Evaporation of river water [L/T]
 - * QRO - River flow entering the river from outside the model area [L³/T]
 - QR - Total river flow [L³/T]
-
- - Calculated by code
 - * - Optional input variable

Figure 3. River channel geometry and parameters

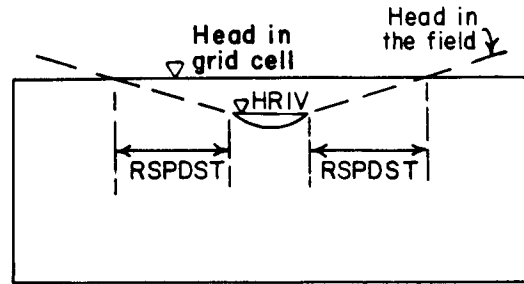

- a. Cross-sectional view of grid cell with river and estimation of horizontal seepage distance.

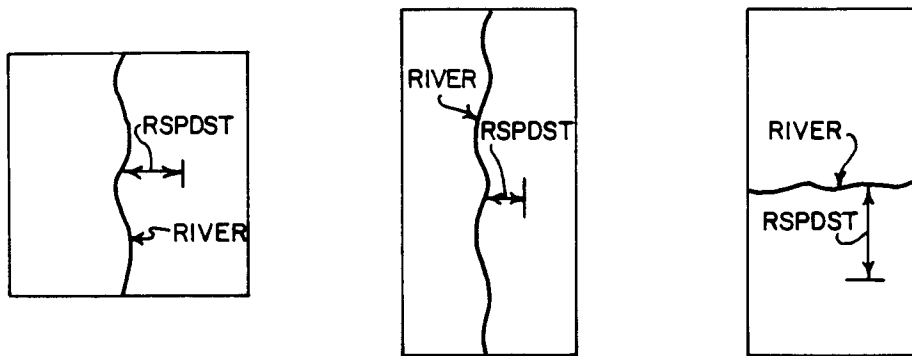

- b. Plan views of grid cells and estimation of horizontal seepage distance.

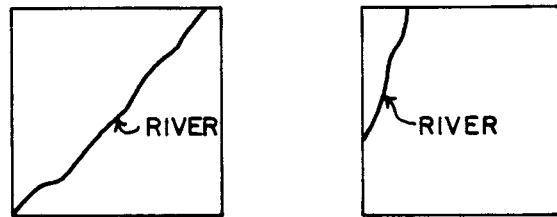

- c. Plan views of grid cells and possible river positions. User must make a reasonable estimate of horizontal seepage distance.

Figure 4. Horizontal seepage distance between river and grid cell

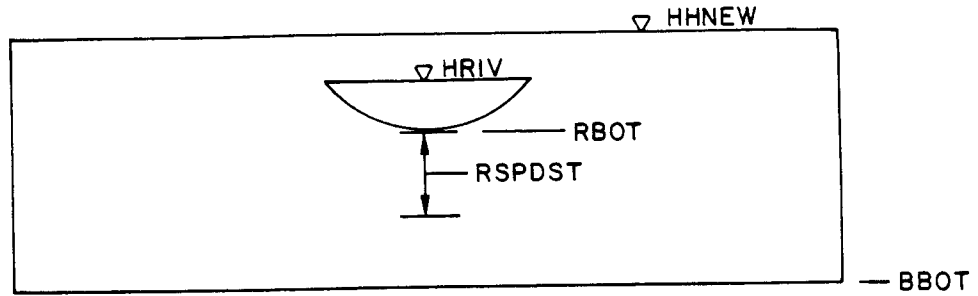

$$RSPDST = 0.5 * (RBOT - BBOT)$$

- a. Vertical seepage distance default calculated by the program. No silt layer.

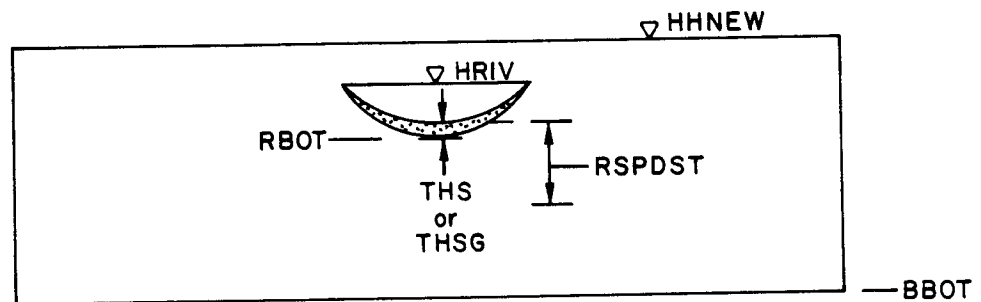

$$RSPDST = 0.5 * (RBOT - BBOT) + THS$$

or

$$RSPDST = 0.5 * (RBOT - BBOT) + THSG$$

- b. Vertical seepage distance default calculated by the program, with silt layer.

Figure 5. Vertical seepage distance between river and grid cell

Direct additions or deletions to the flow of the river are used in the calculation of mass balance of river flow. A positive value is entered for additions such as return flows or precipitation, and a negative value is entered for deletions such as diversions or evaporation. A value for flow outside the groundwater flow model, QRO, should be entered as a positive value if there is flow into the simulated area from an upstream river reach outside the modeled area. Flow from outside the groundwater flow model should be entered for a river reach such as reach #1 in Figure 2.

River Geometry and Flux Input Variables

HRIV - river stage [L]
 RBOT - elevation of river channel bottom [L]
 BWID - bottom width of channel [L]
 SIDE - slope of the side of the channel [L/L]
 AN - Manning roughness coefficient [dimensionless]
 RLNG - length of river [L]
 SHY - vertical hydraulic conductivity of silt layer [L/T] (optional)
 THS - thickness of silt layer [L] (optional)
 SGHY - vertical hydraulic conductivity of silt layer - gaining river [L/T] (optional)
 THSG - thickness of silt layer - gaining river [L] (optional)
 HNEG - negative air entry pressure [L] (optional)
 RSLP - energy gradient in river [dimensionless] enter only if no upstream or downstream reaches
 RSPDST - horizontal seepage distance between river and groundwater aquifer [L] (optional)
 enter only if IRVTYP = 0 or NOAL = 1
 QRDVR - river diversions [L³/T] (optional)
 QRRF - return flow [L³/T] (optional)
 RPRCP - precipitation falling on river reach [L/T] (optional)
 REVAP - evaporation of river water [L/T] (optional)
 QRO - river flow entering the channel from outside the groundwater model [L³/T] (optional)

Alluvium Geometry and Flux Input

Alluvium is modeled as a rectangle (Figure 6). Although alluvium may be irregular in shape, an equivalent rectangle will provide reasonable results in the seepage calculations. Bottom elevation of the alluvium, ABOT, should be an average elevation for the bottom of the alluvium, and the width, WIDA, should be an average width. Initial head in the alluvium, HAL, should be a reasonable estimate of the current head.

Length of the alluvial reach may be less than the length of the river due to the sinuosity of rivers (Figure 7). However, if the length of the alluvium is approximately equal to the length of the river, the value may be omitted from the input and the length of the alluvium will default to the length of the river.

Hydraulic conductivity, AHY, is the average hydraulic conductivity for the alluvium in the grid cell. Specific yield, SYA, is the average specific yield for the alluvium in the grid cell.

ASPDST is an estimate of the horizontal distance of seepage of ground water between the alluvium and the grid cell. ASPDST can be estimated in the same way as RSPDST. The width of the alluvium must be taken into account when estimating ASPDST. Seepage distance should be determined as illustrated in Figures 8a and 8b. The decision on whether to extend the seepage distance into the alluvium depends on the nature of the hydraulic system in the field. If the alluvium has a high hydraulic conductivity relative to the surrounding bedrock, such that the head in the alluvium is essentially constant across its width, then ASPDST should be measured outward from the edge of the alluvium. If there is substantial difference in the head across the alluvium, perpendicular to the river, then the midpoint between the river and the edge of the alluvium is roughly the point where the average head in the alluvium prevails and should be used to

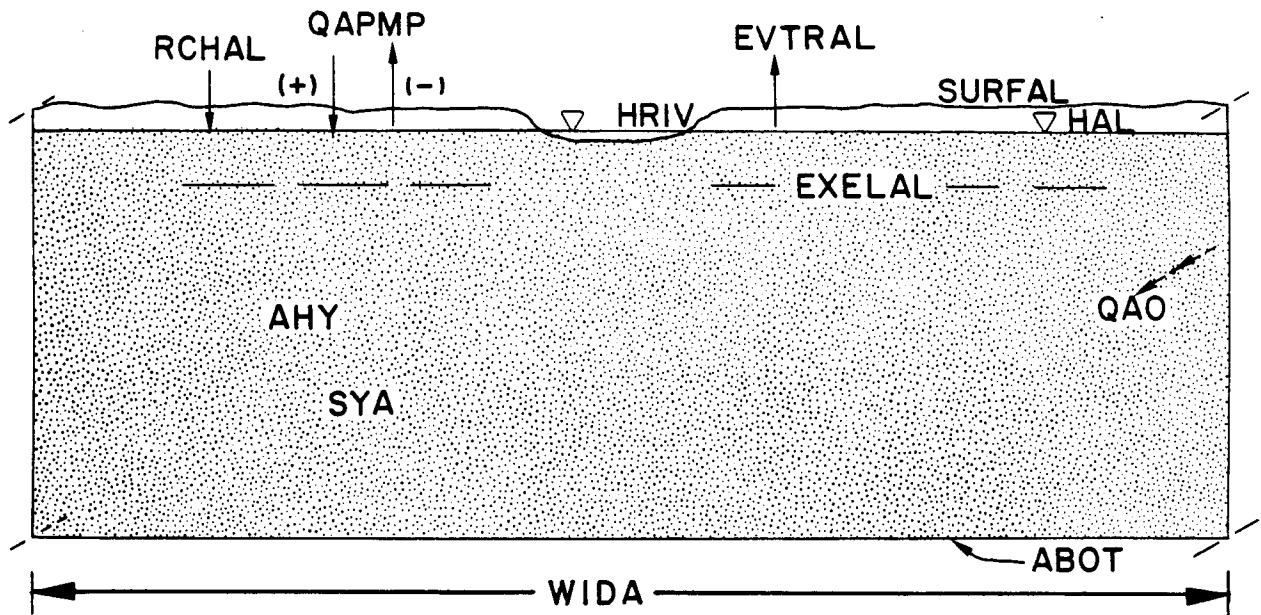

- HAL - Head in alluvium [L]
 - ABOT - Bottom elevation of alluvium [L]
 - WIDA - Width of alluvium [L]
 - AHY - Hydraulic conductivity of alluvium [L/T]
 - SYA - Specific yield of alluvium []
 - * RCHAL - Recharge [L/T]
 - * EVTRAL - Evapotranspiration rate [L/T]
 - * SURFAL - Land surface elevation [L]
 - * EXELAL - Extinction elevation for evapotranspiration [L]
 - * QAPMP - Withdrawal (-) or injection (+) [L³/T]
 - * QAO - Flux from upstream alluvial segment outside of model [L³/T]
- * Optional input variable
- Calculated by code

Figure 6. Alluvium parameters

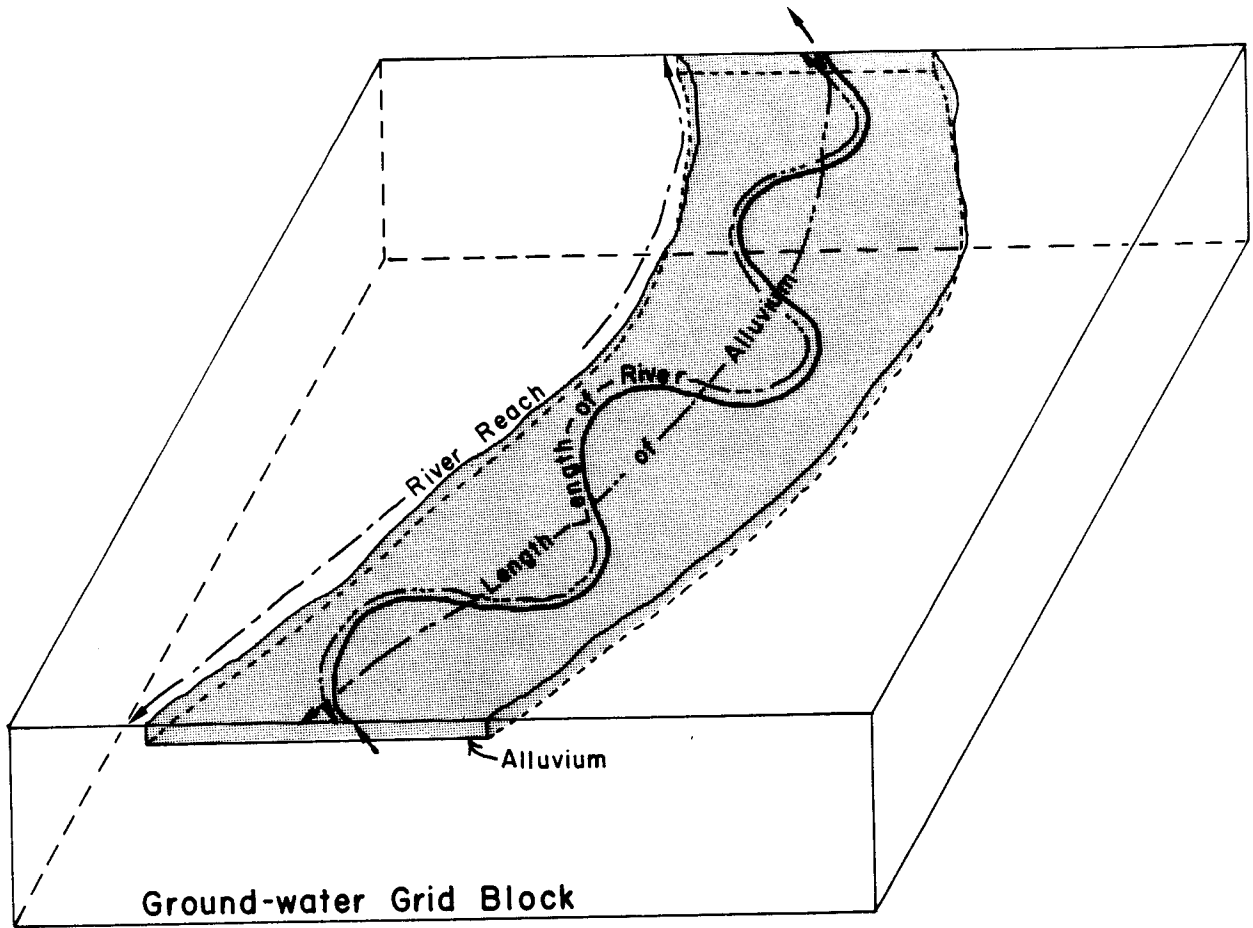
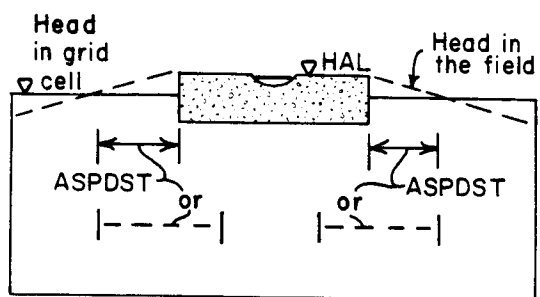
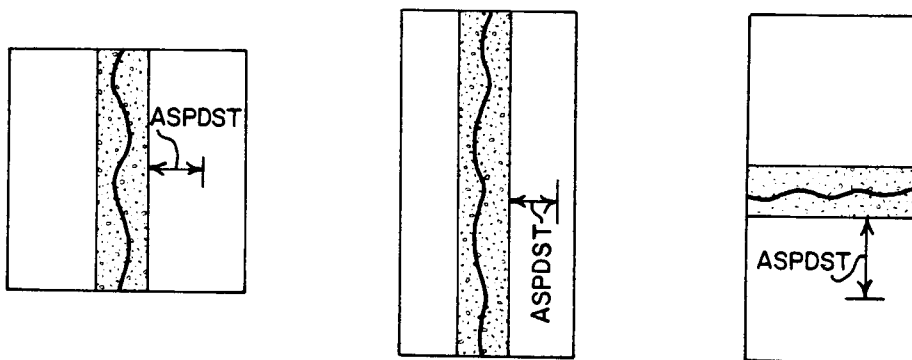

Figure 7. Length of river and alluvial reaches



a. Cross-sectional view of grid cell with alluvium and alternative horizontal seepage distances.



b. Plan views of grid cells and estimation of horizontal seepage distance.

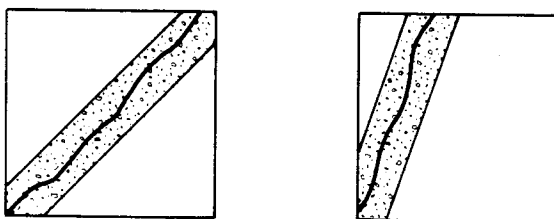

c. Plan views of grid cells and possible alluvium positions. User must make a reasonable estimate of horizontal seepage distance.

Figure 8. Horizontal seepage distance between alluvium and grid cell

determine ASPDST. Figure 8c illustrates special situations in which the users will have to make a reasonable estimation of alluvium seepage distance based on their knowledge of the system being simulated.

Vertical seepage between the alluvium and the bedrock will be calculated by the program if the user does not enter a value for ASPDST. The vertical seepage distance is the distance from the center of the saturated thickness of the alluvium to half the distance between the bottom of the alluvium to the bottom of the grid cell (Figure 9).

Gradient of the alluvium, ASLP, is entered only for alluvium reaches that do not have both a downstream and upstream alluvial reach (LUP1=0 and LDN=0), for example reach #7 in Figure 2. If a value is not entered for a reach for which there is no upstream reach and downstream reach, an error message will be printed and the program terminated. Gradient in the alluvium is calculated for river reaches by the RIVINT program for all other reaches.

Other optional input includes recharge rate and information on evapotranspiration. Evapotranspiration is assumed to be at the rate specified for EVTRAL when the head is at the ground surface and declines linearly to zero at EXELAL, the extinction elevation for evapotranspiration. Evapotranspiration is calculated in the same way as described in the evapotranspiration chapter of the MODFLOW user's manual (McDonald and Harbaugh, 1988).

Alluvium Geometry and Flux Input Variables

HAL - head in alluvium [L]
 ABOT - bottom elevation of alluvium [L]
 WIDA - width of alluvium [L]
 AHY - horizontal hydraulic conductivity of alluvium [L/T]
 ALNG - length of alluvium [L] (optional)
 SYA - specific yield of alluvium [dimensionless]
 ASPDST - horizontal seepage distance between river and groundwater aquifer [L] (optional)
 ASLP - gradient of alluvium - enter only if no upstream and downstream reaches [L/L]
 RCHAL - recharge to alluvium [L/T] (optional)
 EVTRAL - maximum evapotranspiration rate for alluvium [L/T]
 SURFAL - evapotranspiration surface elevation [L]
 EXELAL - extinction elevation [L]
 QAPMP - net withdrawal (-) or injection (+) into alluvium [L³/T] (optional)

COMPUTATION OF RIVER AND ALLUVIUM CONDUCTANCE AND SEEPAGE RATES

The third subroutine, RINT2FM, calculates a conductance term which is sent back to the main program and used in the calculation of head in the grid cell. An explanation of how this conductance term is incorporated into the MODFLOW program is explained in the chapter on cell centered flow and the chapter explaining the river module in McDonald and Harbaugh (1988). If the reach contains only a river, then the conductance between the river and the grid cell is calculated. If the reach contains alluvium, then the conductance between the alluvium and the grid cell is calculated.

The hydraulic conductance between the river and grid cell, CRIV, or between the alluvium and grid cell, CAL, is equal to:

$$K \times L \times W / M$$

where:

K = hydraulic conductivity

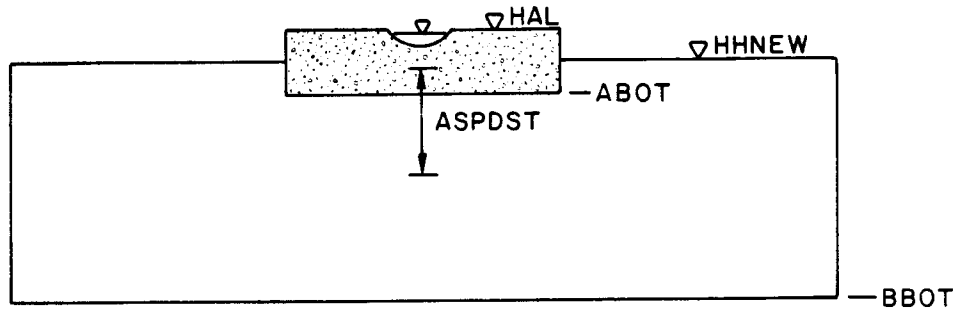

$$ASPDST = 0.5 * (HAL - BBOT)$$

Figure 9. Vertical seepage distance between alluvium and grid cell

L = length of reach
 W = width of river
 M = distance over which seepage takes place

Flow between the river and grid cell, or between the alluvium and grid cell (where saturation is continuous between the river and grid cell or alluvium and grid cell), is calculated by multiplying the conductance term by the difference in head between the two. In the case of a disconnected system, the conductance term is multiplied by the river depth or saturated thickness of the alluvium. Length of the reach corresponds to the variable RLNG for rivers or ALNG for alluvium. Width of the river is the projection of the wetted perimeter of the river on a horizontal plane (Figure 10), or for alluvium, the variable WIDA which is the width of the alluvium. Seepage distance is RSPDST for rivers or ASPDST for alluvium. Hydraulic conductivity depends on conditions in the river or alluvium and the relationship between head in the grid cell and head in the river or alluvium. This is explained further in the following sections.

Conductance Between River and Grid Cell

Four different conditions between the river and grid cell are possible; 1) the river is gaining, 2) the river is losing and is connected to the groundwater table by a saturated zone, 3) the river is losing but is perched above the groundwater table, or 4) the river is dry and the water table is below the bottom of the river so there is no seepage (Figure 11). In each case, a silt layer may or may not be present, as determined by the user. If a silt layer is present and saturated conditions prevail, an equivalent hydraulic conductivity between the two is calculated as:

$$\text{Equivalent } K = d / (d_1 / K_1 + d_2 / K_2)$$

where:

d = total thickness of silt layer and underlying grid cell
 d₁ = thickness of silt layer
 K₁ = hydraulic conductivity of silt layer
 d₂ = thickness of grid cell below river bottom
 K₂ = hydraulic conductivity of grid cell

Figure 12 illustrates how this equation is translated in the RIVINT code for a losing or a gaining river with a silt layer. For a losing river, the equation for equivalent vertical hydraulic conductivity of the river bed and the grid cell, SBEQVK [L/T], is:

$$\text{SBEQVK} = (\text{RIVBOT} - \text{BBOT}) / ((\text{THS} / \text{SHY}) + (\text{RBOT} - \text{BBOT}) / \text{BHY})$$

where:

RIVBOT - elevation of the channel bottom (top of silt layer) [L]

RIVBOT = RBOT + THS (or THSG as appropriate)

For a gaining river:

$$\text{SBEQVK} = (\text{RIVBOT} - \text{BBOT}) / ((\text{THSG} / \text{SGHY}) + (\text{RBOT} - \text{BBOT}) / \text{BHY})$$

A gaining river may or may not have a silt layer. If a silt layer is present, the conductance term, CRIV [L²/T], is calculated as (Figure 13):

$$\text{CRIV} = \text{SBEQVK} * \text{projection of wetted perimeter} * \text{length of reach} / \text{seepage distance}$$

or:

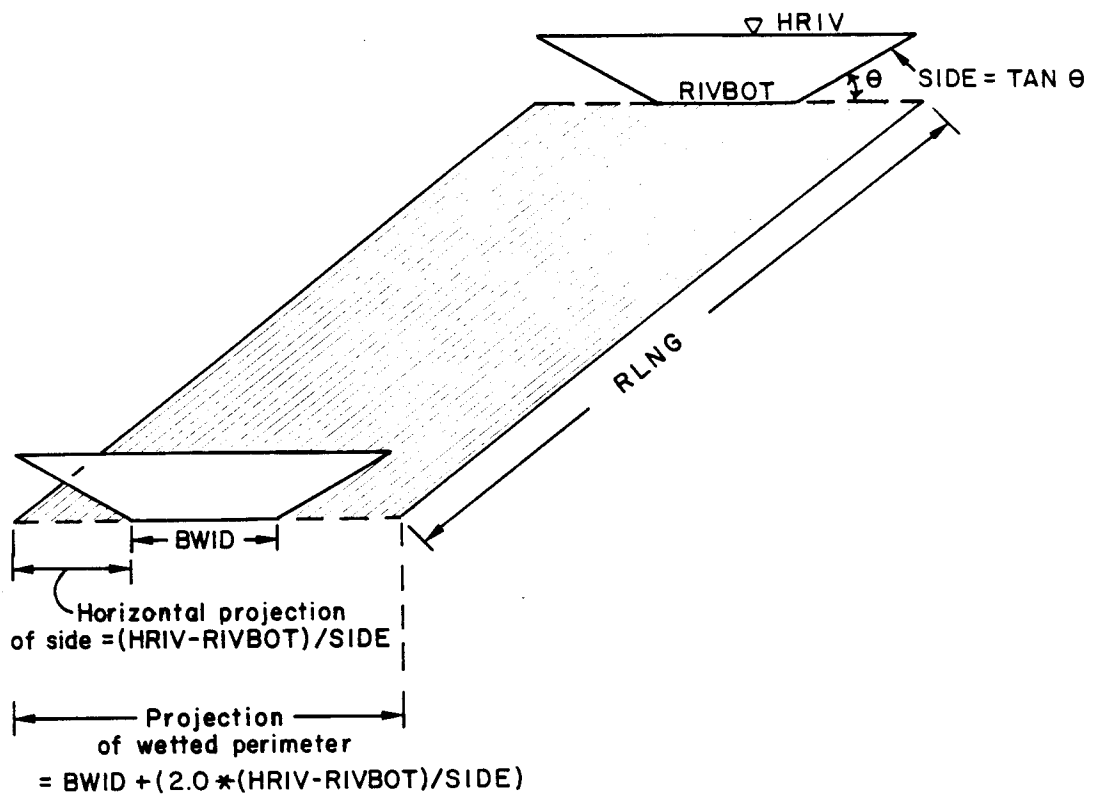

Figure 10. Area of river seepage

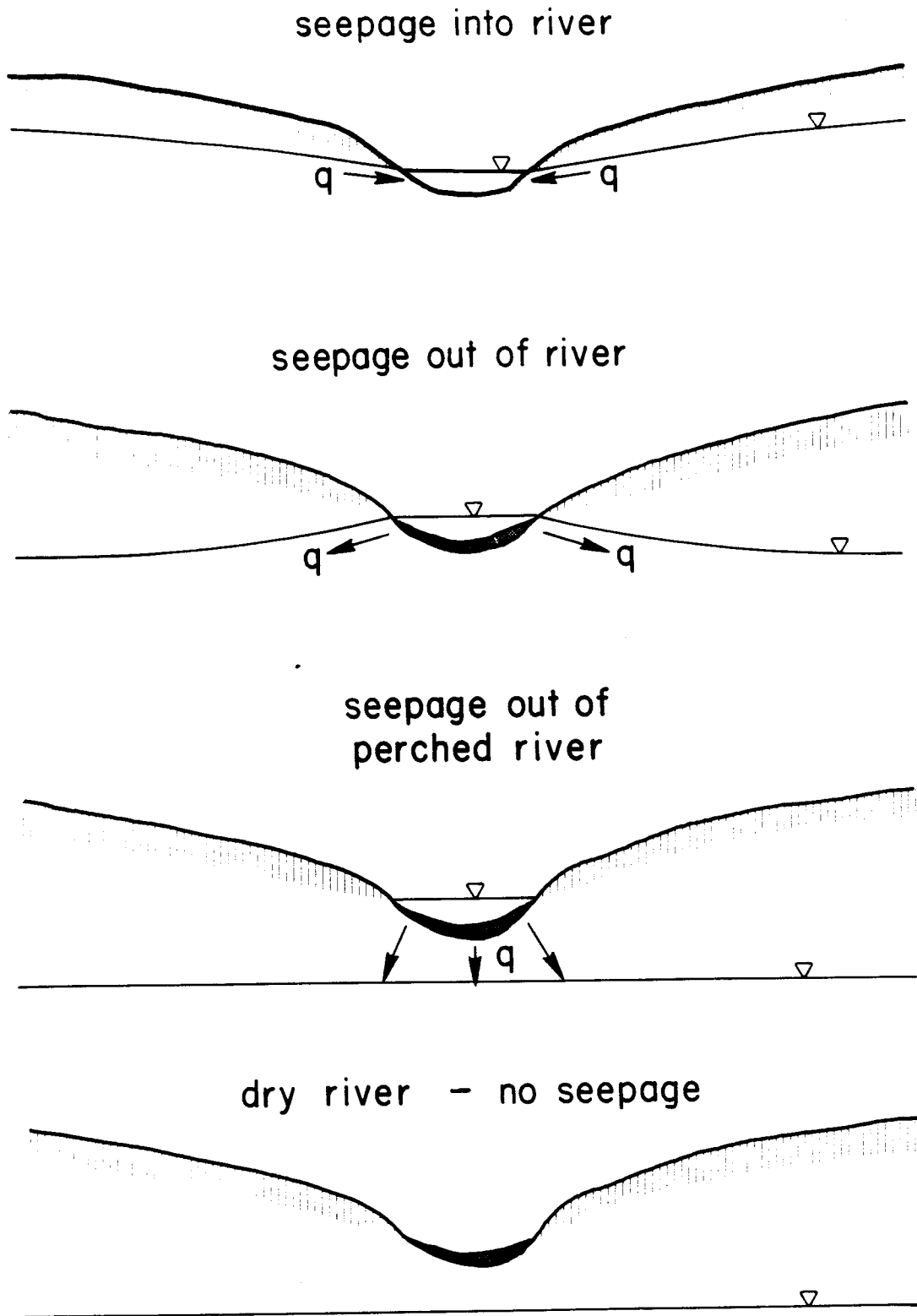
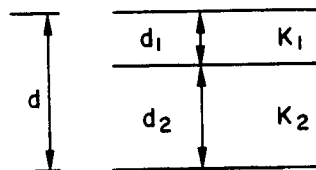
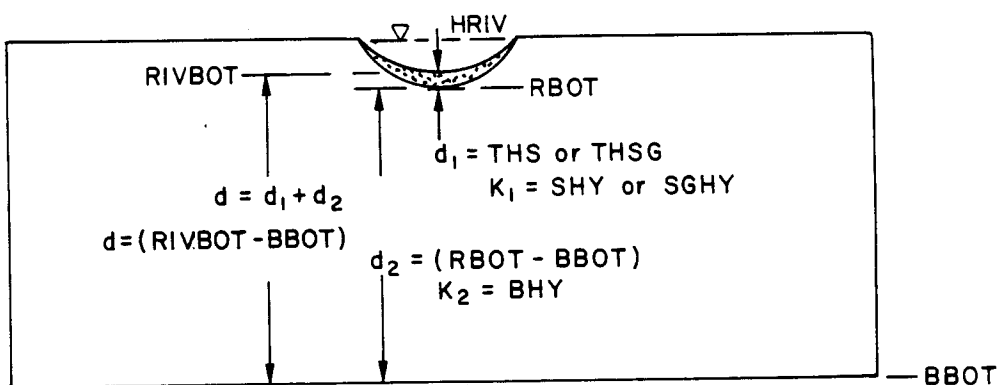

Figure 11. Conditions of river seepage

$$K = \frac{d}{\sum_{i=1}^n \frac{d_i}{K_i}}$$



$$\text{Equivalent } K = \frac{d}{\frac{d_1}{K_1} + \frac{d_2}{K_2}}$$



Losing river with silt layer

$$\text{SBEQVK} = (\text{RIVBOT} - \text{BBOT}) / ((\text{THS} / \text{SHY}) + (\text{RBOT} - \text{BBOT}) / \text{BHY})$$

Gaining river with silt layer.

$$\text{SBEQVK} = (\text{RIVBOT} - \text{BBOT}) / ((\text{THSG} / \text{SGHY}) + (\text{RBOT} - \text{BBOT}) / \text{BHY})$$

Figure 12. Equivalent hydraulic conductivity between river and grid cell

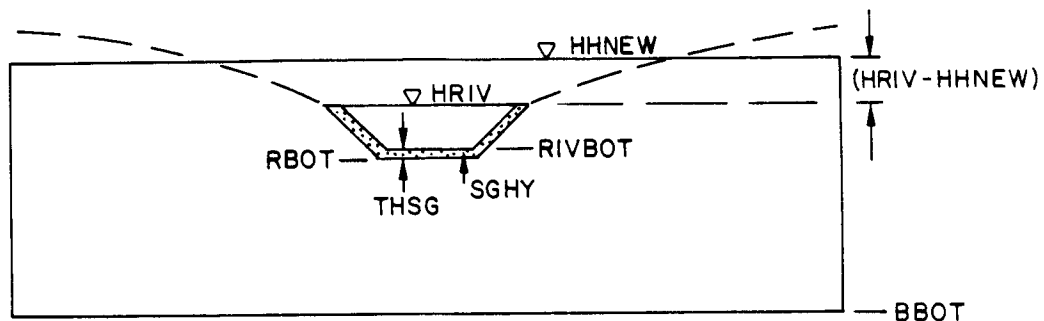

Gaining river with silt layer.

Conductance:

$$CRIV = SBEQVK * (BWID + (2.0 * (HRIV - RIVBOT) / SIDE)) * RLNG / RSPDST$$

Seepage rate:

$$QRB = CRIV * (HRIV - HHNEW)$$

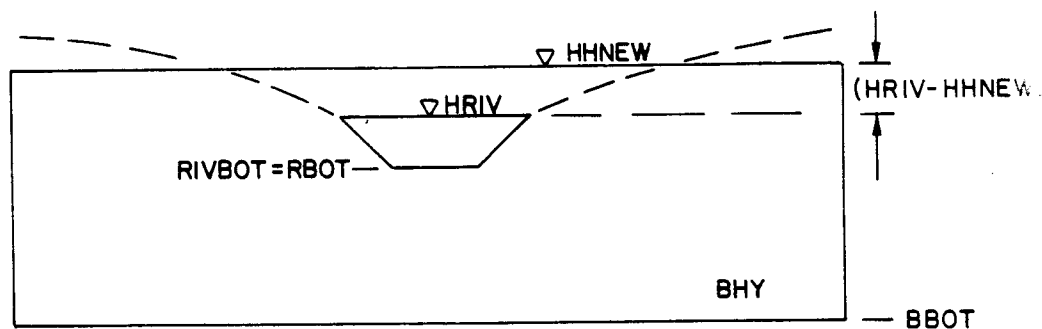

Gaining river without silt layer.

Conductance:

$$CRIV = BHY * (BWID + (2.0 * (HRIV - RIVBOT) / SIDE)) * RLNG / RSPDST$$

Seepage rate:

$$QRB = CRIV * (HRIV - HHNEW)$$

Figure 13. Conductance and seepage for a gaining river

$$CRIV = SBEQVK * (BWID + (2.0 * (HRIV - RIVBOT) / SIDE)) * RLNG / RSPDST$$

If a gaining river does not have a silt layer, the hydraulic conductivity of the grid cell is used in place of the equivalent hydraulic conductivity and the equation becomes:

$$CRIV = BHY * (BWID + (2.0 * (HRIV - RIVBOT) / SIDE)) * RLNG / RSPDST$$

Conductance between a losing river with a silt layer, which is connected with the underlying grid cell by a zone of saturation, and a grid cell is calculated in the same way as a gaining river with a silt layer (Figure 14). If a silt layer is not present, the hydraulic conductivity of the grid cell is used in place of the equivalent hydraulic conductivity (Figure 14).

Conductance between a losing, perched river and a grid cell is calculated using the hydraulic conductivity of the silt layer (Figure 15):

$$CRIV = SHY * (BWID + (2.0 * (HRIV - RIVBOT) / SIDE)) * RLNG / THS$$

Conductance between a losing, perched river, without a silt layer and a grid cell is calculated as (Figure 15):

$$CRIV = BHY * (BWID + (2.0 * (HRIV - RIVBOT) / SIDE)) * RLNG / (HRIV - RIVBOT)$$

A river may be dry and the head in the grid cell may be below the bottom of the river. In this case, there is no conductance between the river and the grid cell.

Seepage rate calculations between river and grid cell

Seepage rate between the river and the grid cell is calculated in the fourth subroutine. Seepage is positive when the grid cell is gaining water and negative when it is losing water. For saturated flow, the seepage rate, $QRB [L^3/T]$, is calculated as (Figures 13 and 14):

$$QRB = CRIV * (HRIV - HHNEW)$$

where:

$$HHNEW = \text{new head calculated in this iteration for the grid cell [L]}$$

For a perched river with a silt layer, the seepage rate is dependent on the head in the alluvium and negative air entry pressure and is calculated as (Figure 15):

$$QRB = CRIV * (HRIV - RIVBOT + HNEG)$$

For a perched river without a silt layer, the seepage rate is calculated as (Figure 15):

$$QRB = CRIV * (HRIV - RIVBOT)$$

For situations where the river is dry and the head in the grid cell is below the river bottom, $QRB = 0$.

Conductance Between Alluvium and Grid Cell

Four possible conditions may exist between the alluvium and grid cell. The alluvium and grid cell are connected by a saturated zone (Figure 16a), the alluvium is not dry and the head in the grid cell is below the bottom of the alluvium (Figure 16b), the alluvium is dry and the head in the grid cell is above the

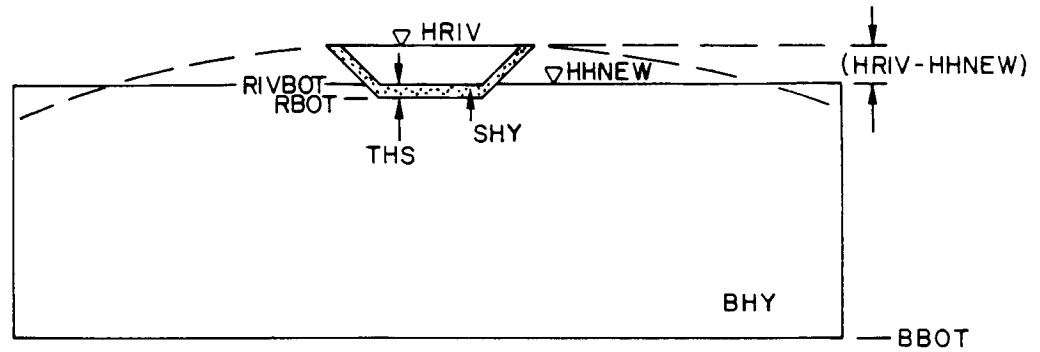

Losing river - with silt layer.

Conductance:

$$CRIV = SBEQVK * (BWID + (2.0 * HRIV - RIVBOT) / SIDE)) * RLNG / RSPDST$$

Seepage rate:

$$QRB = CRIV * (HRIV - HHNEW)$$

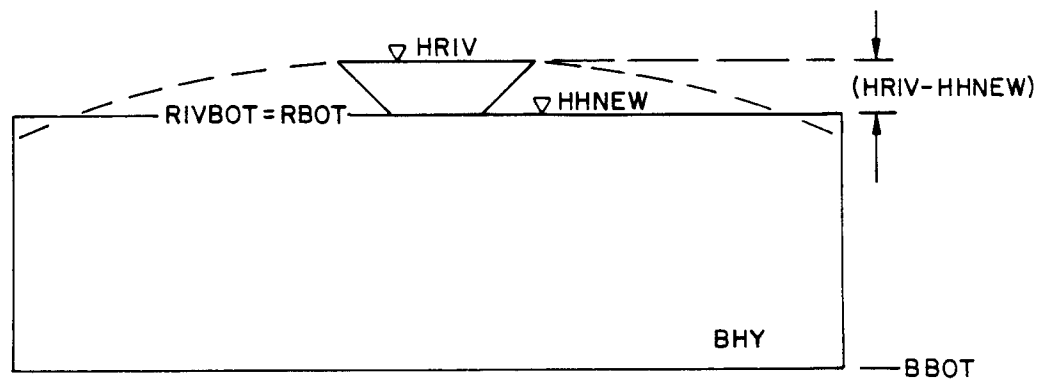

Losing river - without silt layer.

Conductance:

$$CRIV = BHY * (BWID + (2.0 * (HRIV - RIVBOT) / SIDE)) * RLNG / RSPDST$$

Seepage rate:

$$QRB = CRIV * (HRIV - HHNEW)$$

Figure 14. Conductance and seepage for a losing river under fully saturated conditions

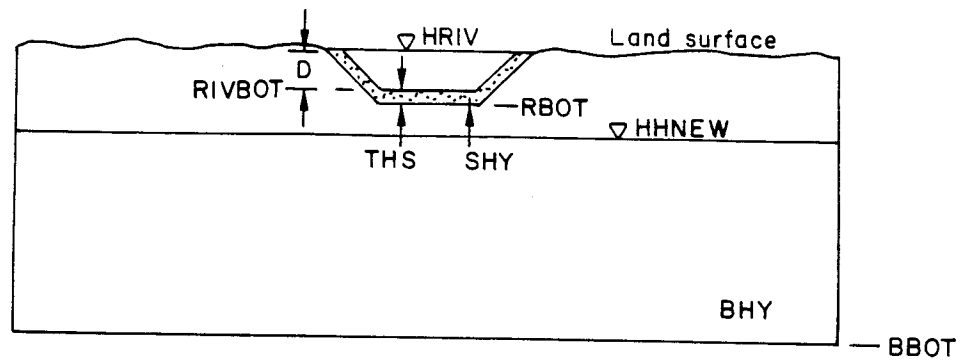

Perched losing river with silt layer.

Conductance:

$$CRIV = SHY * (BWID + (2.0 * (HRIV - RIVBOT) / SIDE)) * RLNG / THS$$

Seepage rate:

$$QRB = CRIV * (D + HNEG) \quad D = (HRIV - RIVBOT)$$

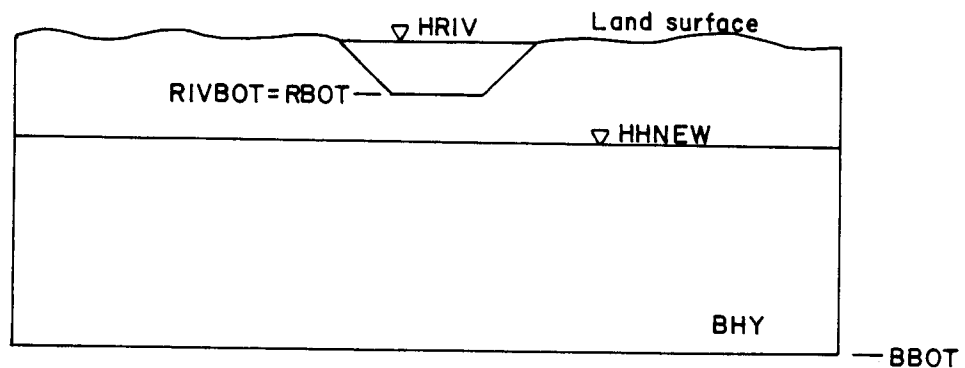

Perched losing river without silt layer.
gradient = 1

Conductance:

$$CRIV = BHY * (BWID + (2.0 * (HRIV - RIVBOT) / SIDE)) * RLNG / (HRIV - RIVBOT)$$

Seepage rate:

$$QRB = CRIV * D \quad D = (HRIV - RIVBOT)$$

Figure 15. Conductance and seepage for a perched river

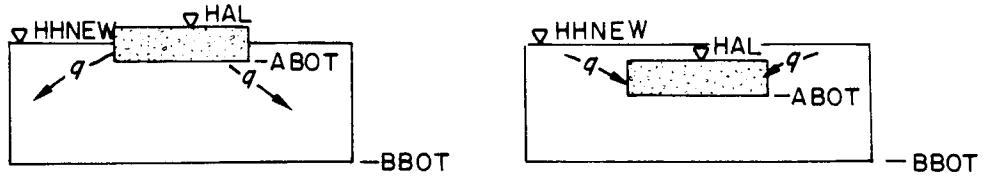

a. Saturated flow between alluvium and bedrock.

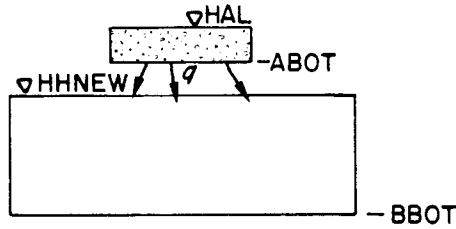

b. Head in bedrock is below head in alluvium - unsaturated flow.

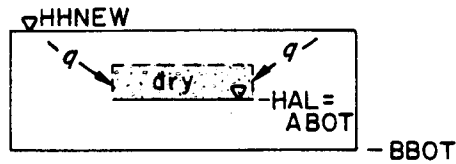

c. Alluvium is dry and head in bedrock is above bottom of alluvium.

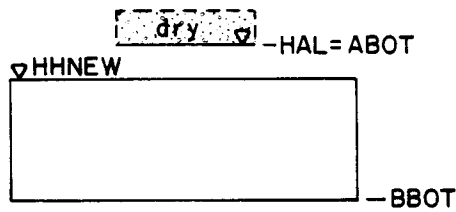

d. Alluvium is dry and head in bedrock is below bottom of alluvium - no seepage.

Figure 16. Conditions of alluvium/grid cell seepage

bottom of the alluvium (Figure 16c), the alluvium is dry and the head in the grid cell is below the bottom of the alluvium (Figure 16d).

If the alluvium is not dry and saturation is continuous between the alluvium and grid cell, equivalent hydraulic conductivity is calculated as (Figure 17):

$$EQVK = (HAL-BBOT)/((HAL-ABOT)/AHY + (HHNEW-BBOT)/BHY)$$

where HHNEW is the head in the grid cell. Conductance between the alluvium and the grid cell, CAL [L²/T] is (Figure 18):

$$CAL = EQVK * WIDA * ALNG / ASPDST$$

If the alluvium is not dry and the head in the grid cell is below the bottom of the alluvium, the flow is unsaturated and the gradient is assumed to be equal to 1. Conductance between the alluvium and the grid cell is (Figure 19):

$$CAL = BHY * WIDA * ALNG / (HAL-ABOT)$$

If the alluvium is dry and the head in the grid cell is above the bottom of the alluvium, the equivalent hydraulic conductivity is calculated as (Figure 17):

$$EQVK2 = (HHNEW - BBOT) / ((HHNEW-ABOT)/AHY + (ABOT-BBOT)/BHY)$$

Then, conductance between the alluvium and the grid cell is (Figure 20):

$$CAL = EQVK2 * WIDA * ALNG / ASPDST$$

Seepage rate calculations between alluvium and grid cell

The seepage rate between the alluvium and grid cell is calculated in the fourth subroutine if alluvium is included as part of the river reach. For saturated flow conditions, the calculation for seepage rate between alluvium and the grid cell, QAB [L³/T], is (Figures 18 and 20):

$$QAB = CAL * (HAL - HHNEW)$$

Seepage rate for perched conditions where the head in the grid cell is below the bottom of the alluvium, but the alluvium is not dry, the seepage rate is dependent on the saturated thickness of the alluvium, and the calculation for seepage rate is (Figure 19):

$$QAB = CAL * (HAL - ABOT)$$

If the alluvium is dry and the head in the grid cell is below the bottom of the alluvium, QAB = 0.

Seepage between river and alluvium

Seepage between river and alluvium is calculated in the fourth subroutine for river reaches containing alluvium. Calculations for seepage between the river and alluvium are essentially the same as described between a river and grid cell, substituting in alluvium parameters instead of grid cell parameters (Figures 21 through 23). The only difference between calculation of river/grid cell seepage and river/alluvium seepage is that vertical seepage is assumed between the river and alluvium. The calculation for vertical seepage distance is the same as described previously in the section on river parameter input.

$$K = \frac{d}{\sum_{i=1}^n \frac{d_i}{K_i}}$$

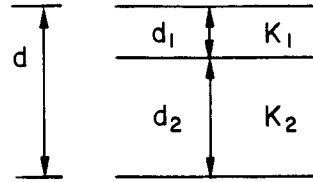

$$\text{Equivalent } K = \frac{d}{\frac{d_1}{K_1} + \frac{d_2}{K_2}}$$

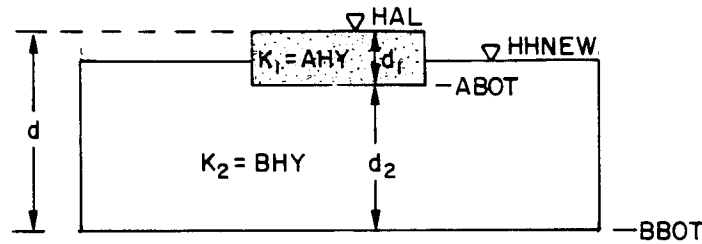

- a. Alluvium and bedrock
 $EQVK = (HAL - BBOT) / ((HAL - ABOT) / AHY + (HHNEW - BBOT) / BHY)$

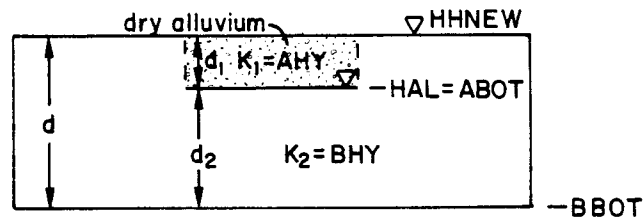

- b. Alluvium is dry - alluvium and bedrock
 $EQVK2 = (HHNEW - BBOT) / ((HHNEW - ABOT) / AHY + (ABOT - BBOT) / BHY)$

Figure 17. Equivalent hydraulic conductivity between alluvium and grid cell

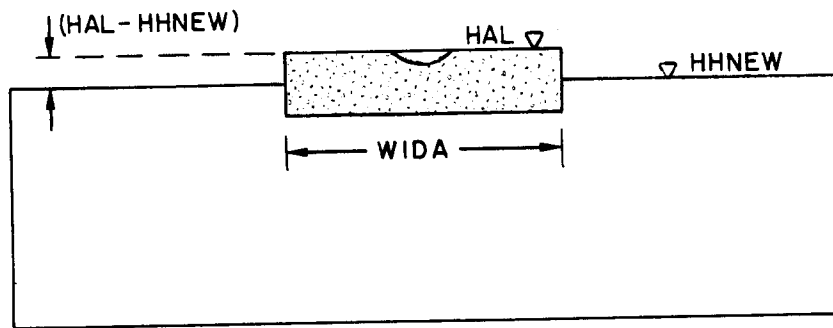

Alluvium and bedrock

Conductance:

$$CAL = EQVK * WIDA * ALNG / ASPDST$$

Seepage rate:

$$QAB = CAL * (HAL - HHNEW)$$

Figure 18. Conductance and seepage between saturated alluvium and grid cell

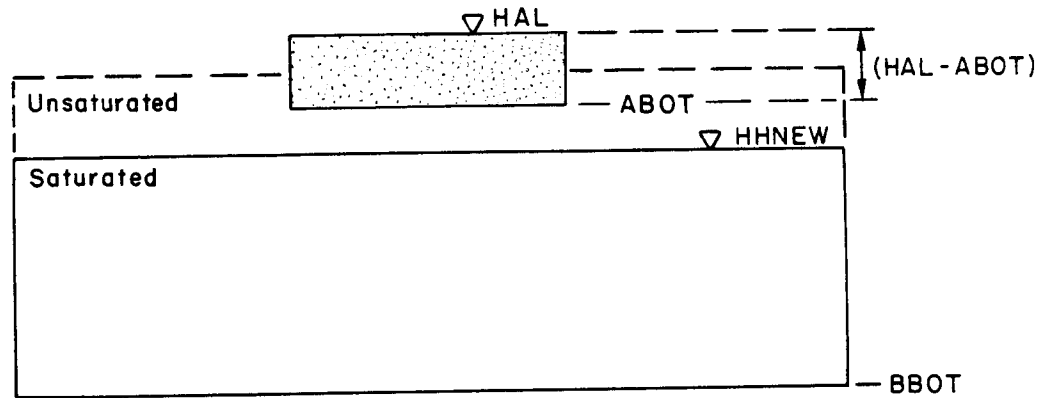

Alluvium and bedrock - perched condition.
 unsaturated flow, gradient (assumed) = 1

Conductance:

$$CAL = BHY * WIDA * ALNG / (HAL - ABOT)$$

Seepage rate:

$$QAB = CAL * (HAL - ABOT)$$

Figure 19. Conductance and seepage between alluvium and unsaturated grid cell

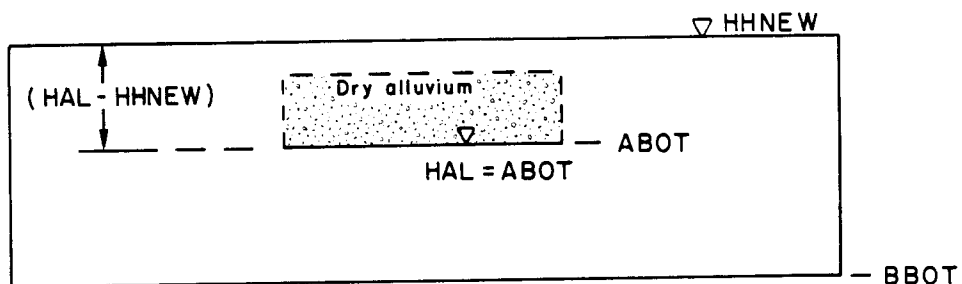

Alluvium is dry - head in bedrock above bottom of alluvium

Conductance:

$$CAL = EQVK2 * WIDA * ALNG / ASPDST$$

Seepage rate:

$$QAB = CAL * (HAL - HHNEW)$$

Figure 20. Conductance and seepage between dry alluvium and saturated grid cell

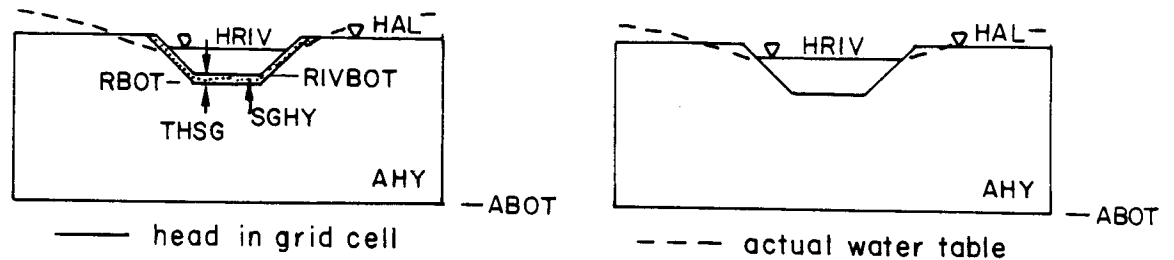

Gaining river with silt layer.

Equivalent hydraulic conductivity:

$$SAEQVK = \frac{(RIBOT - ABOT)}{\frac{THSG}{SGHY} + \frac{RIBOT - ABOT}{AHY}}$$

Seepage rate:

$$QRA = SAEQVK * (HRIV - HAL) / (0.5 * (RIBOT - ABOT) + THSG) * (BWID + (2.0 * (HRIV - RIBOT) / SIDE)) * RLNG$$

Gaining river without silt layer.

Seepage rate:

$$QRA = AHY * (HRIV - HAL) / (0.5 * (RIBOT - ABOT)) * (BWID + (2.0 * (HRIV - RIBOT) / SIDE)) * RLNG$$

Figure 21. Equivalent hydraulic conductivity and seepage between gaining river and alluvium

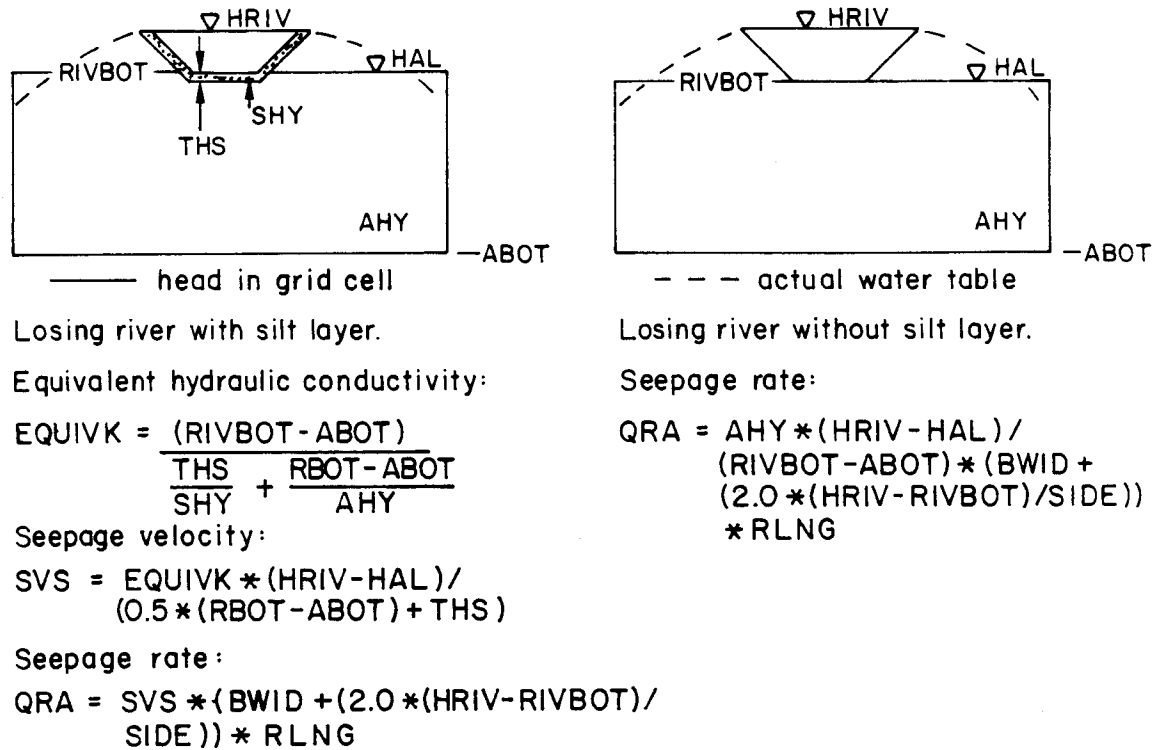
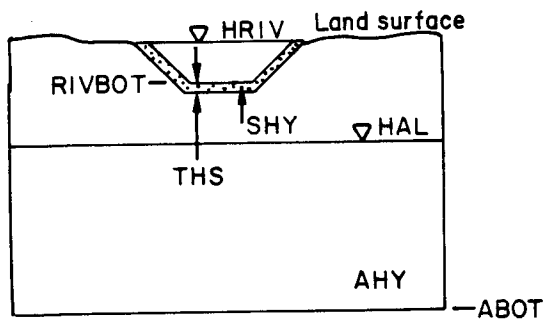

Figure 22. Equivalent hydraulic conductivity and seepage between losing river and alluvium



Perched losing river with silt layer.

Seepage velocity:

$$SVU = SHY * (HRIV - RIVBOT + HNEG) / THS$$

Seepage rate:

$$QRA = SVU * (BWID + (2.0 * (HRIV - RIVBOT) / SIDE)) * RLNG$$

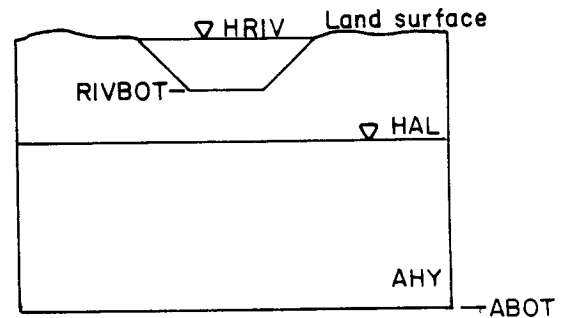

Perched losing river without silt layer.

Seepage rate:

$$QRA = AHY * (BWID + (2.0 * (HRIV - RIVBOT) / SIDE)) * RLNG$$

Figure 23. Seepage form a perched river

CALCULATION OF ENERGY GRADIENT OF RIVER AND ALLUVIUM

Energy gradient of a river reach is used in Manning's equation to calculate river depth. Gradient of the alluvium is used in the calculation of seepage from the alluvium reach into the downstream alluvium reach. Energy gradient is the slope of the energy line of a body of flowing water. Calculation of energy gradient in river reaches and in alluvium, if alluvium is modeled, is included in the program because the head in the river or the head in the alluvium may change with each time step or iteration, and therefore, the energy gradient will also change.

Energy gradient must be input for river and alluvium reaches that are modeled without an upstream reach and a downstream reach such as the river reach #7 in Figure 2. If the energy gradient is not entered for rivers or alluvium reaches without an upstream and a downstream reach, an error message is printed, and the program is terminated. The energy gradient for all other reaches is calculated in the fourth subroutine, RINT1BD.

Calculation of energy gradient of rivers

Energy gradient is calculated as the change in head divided by the distance over which the change in head occurs. Energy gradient for river reaches with a downstream reach and one or more upstream reaches is calculated by first averaging head in the upstream reaches, then subtracting head in the downstream reach, and dividing this head difference by the length of the river reach plus one half the average length of the upstream reaches and one half the length of the downstream reach (Figure 24).

RIVINT tests to determine how many upstream reaches are associated with a river reach. The average head is then calculated for the upstream reach(es), HRAVUP [L], as:

one upstream reach: $HRAVUP = HRVUP1$

two upstream reaches: $HRAVUP = (HRVUP1 + HRVUP2) / 2.0$

three upstream reaches: $HRAVUP = (HRVUP1 + HRVUP2 + HRVUP3) / 3.0$

where:

HRVUP1 = head in the first upstream reach [L]

HRVUP2 = head in the second upstream reach [L]

HRVUP3 = head in the third upstream reach [L]

Average length, DRAVUP [L], is calculated for the upstream reach(es) based on the number of upstream reaches as:

one upstream reach: $DRAVUP = RLNUP1$

two upstream reaches: $DRAVUP = (RLNUP1 + RLNUP2) / 2.0$

three upstream reaches: $DRAVUP = (RLNUP1 + RLNUP2 + RLNUP3) / 3.0$

where:

RLNUP1 = length of the first upstream reach [L]

RLNUP2 = length of the second upstream reach [L]

RLNUP3 = length of the third upstream reach [L]

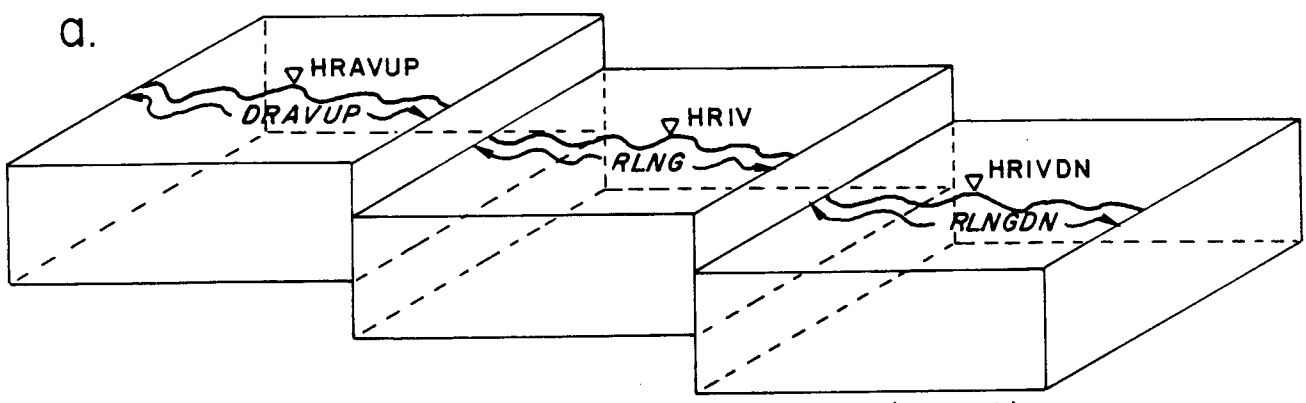

$$RSLP = (HRAVUP - HRIVDN) / (0.5 * (DRAVUP + RLNGDN) + RLNG)$$

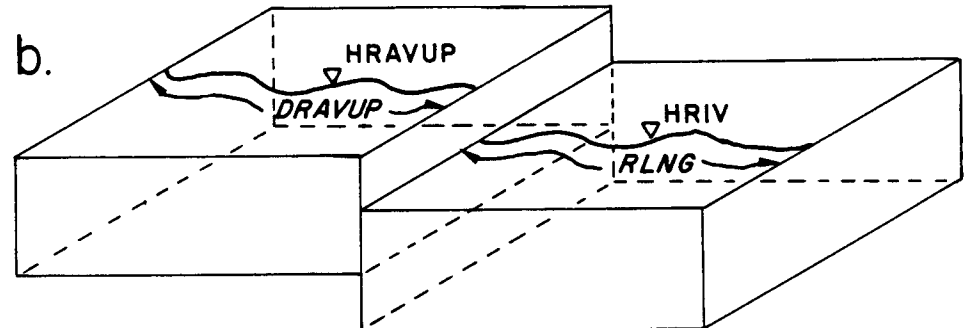

$$RSLP = (HRAVUP - HRIV) / (0.5 * (DRAVUP - RLNG))$$

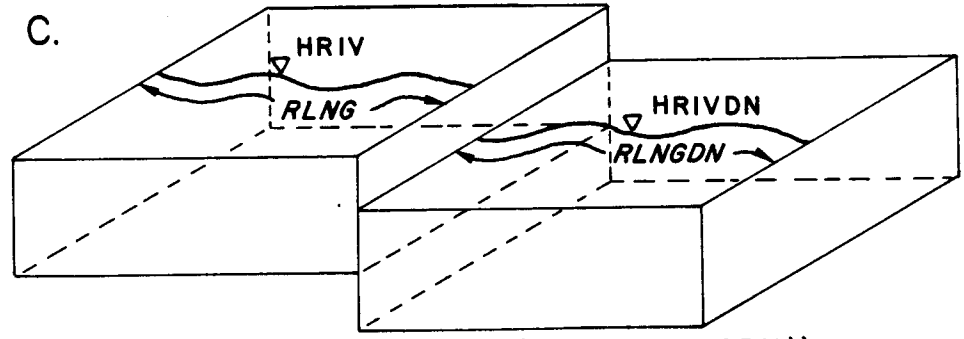

$$RSLP = (HRIV - HRIVDN) / (0.5 * (RLNG + RLNGDN))$$

Figure 24. Gradient in a river reach

Calculation of energy gradient, RSLP [], for a river reach with one or more upstream reaches and a downstream reach is:

$$RSLP = (HRAVUP - HRIVDN) / (0.5*(DRAVUP + RLNGDN) + RLNG)$$

where:

HRIVDN = head in the river in the downstream reach [L]

RLNGDN = length of the downstream river reach [L]

Energy gradient for river reaches that have one or more upstream reaches and no downstream reach, is calculated by subtracting the head difference between the average head in upstream reach(es) and the river reach of interest, and dividing by the one half the average length of the upstream reach(es) plus one half the length of the river reach (Figure 24):

$$RSLP = (HRAVUP - HRIV) / (0.5*(DRAVUP - RLNG))$$

Energy gradient for river reaches that have a downstream reach but no upstream reach is calculated by subtracting the head difference between the river reach and the downstream reach and dividing by one half the length of the river reach plus one half the length of the downstream reach (Figure 24):

$$RSLP = (HRIV - HRIVDN) / (0.5*(RLNG + RLNGDN))$$

Calculation of gradient of alluvium

Gradient for alluvium reaches with a downstream reach and one or more upstream reaches is calculated by dividing the head difference in the alluvium between the average head in the upstream reaches and downstream reach, and dividing this head difference by the length of the alluvium reach plus one half the length of the upstream reach and one half the length of the downstream reach (Figure 25).

RIVINT tests to determine how many upstream reaches are associated with an alluvium reach. The average head, HAAVUP [L], is then calculated for the upstream reach(es) as:

one upstream reach: HAAVUP = HALUP1

two upstream reaches: HAAVUP = (HALUP1 + HALUP2)/2.0

three upstream reaches: HAAVUP = (HALUP1 + HALUP2 + HALUP3)/3.0

where:

HALUP1 = head in the first upstream reach [L]

HALUP2 = head in the second upstream reach [L]

HALUP3 = head in the third upstream reach [L]

Average length is calculated for the upstream reach(es), DAAVUP [L], as:

one upstream reach: DAAVUP = ALNUP1

two upstream reaches: DAAVUP = (ALNUP1 + ALNUP2)/2.0

three upstream reaches: DAAVUP = (ALNUP1 + ALNUP2 + ALNUP3)/3.0

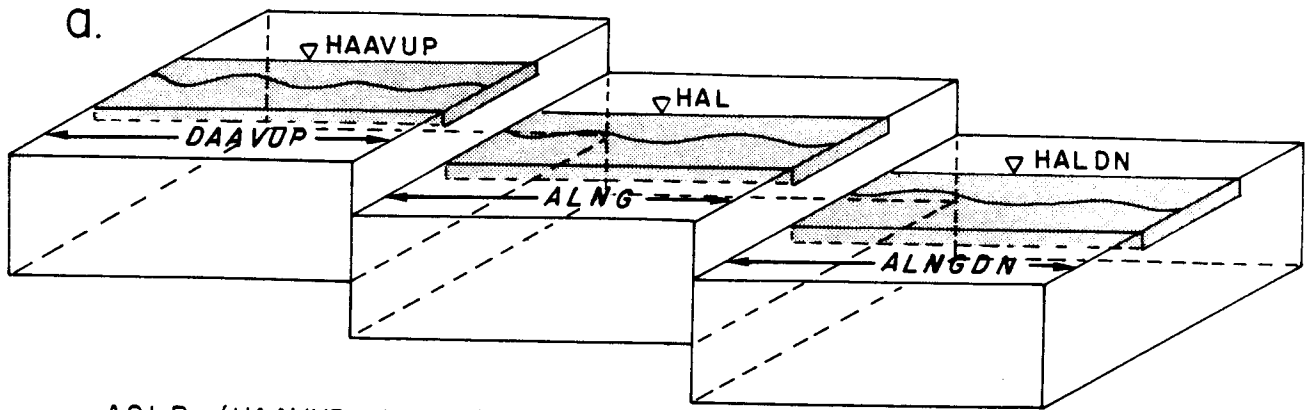

$$ASLP = (HAAVUP - HALDN) / (0.5 * (DAAVUP + ALNGDN) + ALNG)$$

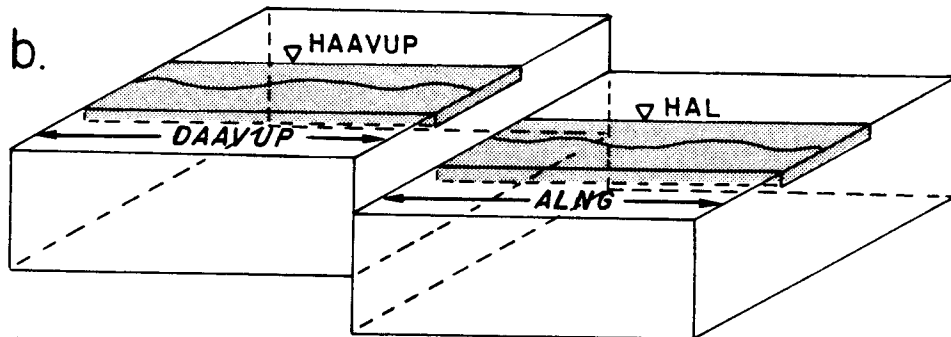

$$ASLP = (HAAVUP - HAL) / (0.5 * (DAAVUP - ALNG))$$

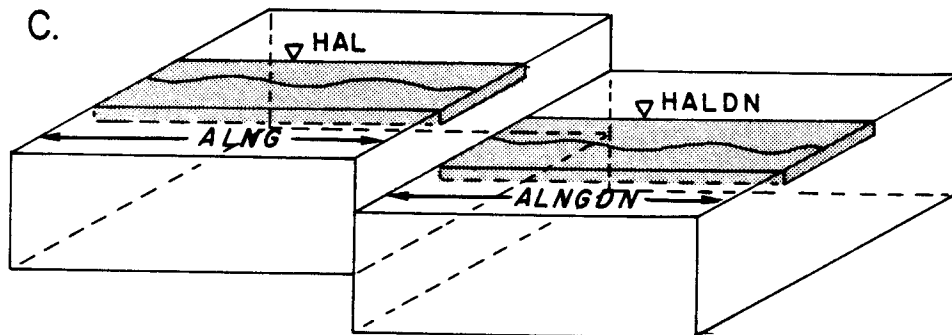

$$ASLP = (HAL - HALDN) / (0.5 * (ALNG + ALNGDN))$$

Figure 25. Gradient in an alluvial reach

where:

ALNUP1 = length of the first upstream reach [L]
 ALNUP2 = length of the second upstream reach [L]
 ALNUP3 = length of the third upstream reach [L]

Calculation for gradient in an alluvium reach, ASLP [], with one or more upstream reaches and a downstream reach is:

$$ASLP = (HAAVUP - HALDN) / (0.5*(DAAVUP + ALNGDN) + ALNG)$$

where:

HALDN = head in the alluvium in the downstream reach [L]
 ALNGDN = length of the downstream alluvium reach [L]

Gradient for alluvium reaches that have one or more upstream reaches and no downstream reach, is calculated by subtracting the head difference between the upstream alluvium reach and the alluvium reach, and dividing by the one half the average length of the upstream reach(es) plus one half the length of the alluvium reach (Figure 25):

$$ASLP = (HAAVUP - HAL) / (0.5*(DAAVUP - ALNG))$$

Gradient for alluvium reaches that have a downstream reach but no upstream reaches is calculated by subtracting the head difference between the alluvium reach and the downstream alluvium reach and dividing by one half the length of the alluvium reach plus one half the length of the downstream alluvium reach (Figure 25):

$$ASLP = (HAL - HALDN) / (0.5*(ALNG + ALNGDN))$$

MASS BALANCE OF RIVER FLOW

Mass balance of river flow is calculated by summing flows into the river. Flows into or out of the river may be from seepage between the river and underlying grid cell, or if alluvium is included, between the river and underlying alluvium, and other flows input by the user such as diversions, return flows, precipitation, or evaporation. The program is designed so that a river reach can have up to three upstream reaches. These upstream reaches are identified by their reach number. The total flow out of the upstream reaches are added together and identified by the variable QRUP which is the inflow to the reach of interest. River reach #4 in Figure 2 will have flow entering from reach #2 and #3.

The value of seepage between river and alluvium, QRA, or between the river and grid cell, QRB, is positive if the river loses water and the alluvium or the grid cell gains water. This is consistent with the sign convention in MODFLOW. QRA or QRB is subtracted in the mass balance equation to maintain the proper sign convention. QRA or QRB is calculated in the time units entered for hydraulic conductivity, and the code converts the value to cfs or cms, dividing by the appropriate number of seconds as described in a previous section in this report.

Some river reaches may have upstream reaches that are outside of the model grid area. The flow coming into the river reach from an outside reach is represented by the variable QRO. This variable may also represent flow entering a river from a lake or reservoir. River reach #1 in Figure 2 would likely have a value for QRO. Volume of water gained by direct precipitation, QRPRCP [L^3/T], and lost via evapotranspiration, QREVAP [L^3/T], are calculated by multiplying the precipitation rate (RPRCP) and the evapotranspiration rate (REVAP) by the projected area of the river.

The total river flow for a river reach that does not include alluvium where the river directly overlies a grid cell is:

$$QR = QRUP - (QRB/SEC) + QRDVR + QRRF + QRPRCP + QREVAP + QRO$$

where:

$$QRUP = \text{the sum of the flow into the reach from upstream reach(es)} [L^3/T]$$

$$QRB/SEC = \text{seepage between river and grid cell the reach in cfs or cms} [L^3/T]$$

The total river flow for a river reach that includes alluvium is (Figure 26):

$$QR = QRUP - (QRA/SEC) + QRDVR + QRRF + QRPRCP + QREVAP + QRO$$

where:

$$QRA/SEC = \text{seepage between river and alluvium in cfs or cms} [L^3/T]$$

The program tests the value of QR to see if the river flow is negative. A message is printed stating that the river flow is negative and the negative value is given. QR is then set to zero to indicate a dry river reach.

RIVER DEPTH CALCULATION

Calculation of river depth is as follows:

1. River flow (calculated previously by mass balance) is used in the simplified Manning's formula to estimate a new river depth.
2. Using the estimated depth, a cross-sectional area, XA, of the trapezoidal river channel is calculated.
3. Using the estimated depth, a wetted perimeter, P, of the trapezoidal river channel is calculated.
4. The cross-sectional area and wetted perimeter values are used in Manning's formula for open channel flow in a trapezoidal channel to calculate an estimated river flow, QREST.
5. The estimated river flow is compared to the beginning river flow to determine if the depth estimate is correct within a set tolerance level, DTOLD. If the river flow is correct within the set tolerance, the depth is acceptable and the loop is exited.
6. If the river flow is too low, the depth is increased by the value, DTOLD, or too high, the depth is decreased by the value, DTOLD, and the program returns to step number 2 and proceeds through the loop again.
7. A counter is incremented each time through the loop. When the maximum number of iterations has been reached, the loop is exited, and an error message is printed including the calculated depth and the last estimate depth.

Flow in an open channel can be calculated from the Manning formula:

$$Q = C/n R^{2/3} S^{1/2} A$$

where:

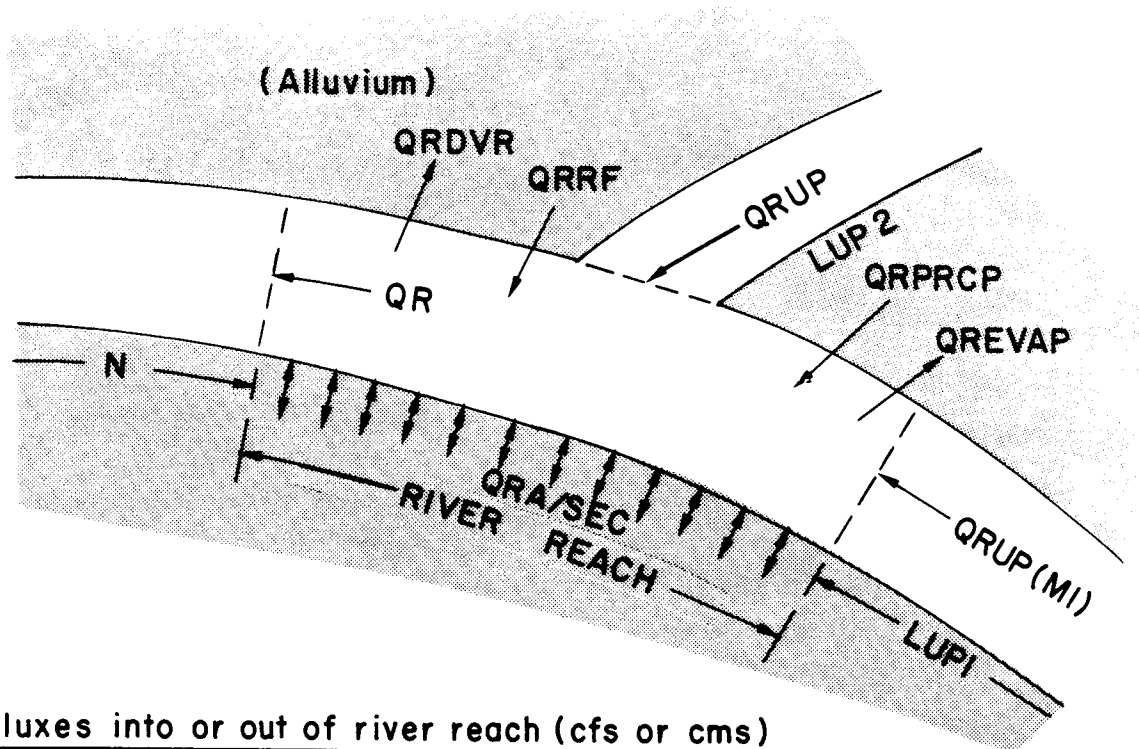

Fluxes into or out of river reach (cfs or cms)

- QRO - Flow from outside the groundwater model (not shown)
- QRDVR - River flow diversions
- QRRF - Return flows to river
- QRPRCP - Precipitation into river
- QREVAP - Evaporation of river water
- QRUP - Inflows from upstream reaches (accumulated)
- QRA/SEC - Seepage to or from alluvium
- QR - Total river flow in reach L

Mass balance

$$QR = QRUP + QRDVR + QRRF + QRPRCP + QREVAP + QRO - (QRA/SEC)$$

Figure 26. Mass balance in a river reach

Q = average discharge, in cubic meters per second in metric units, or cubic feet per second in English units

C = Manning coefficient, C = 1.0 in metric units and C = 1.49 in English units

n = Manning roughness coefficient

R = hydraulic radius of the channel = the cross-sectional area divided by the wetted perimeter of the channel (A/P)

S = energy gradient of the river

A = cross-sectional area of the channel

A simplified version of Manning's formula for open channel flow is used to make an initial estimate of river depth. The simplified Manning's formula assumes that the river width is much greater than the river depth. Thus, the equation can be simplified by ignoring the depth in calculation of the wetted perimeter and ignoring the slope of the sides in calculation of the area. Therefore, the wetted perimeter of the channel is the width of the channel, and the cross-sectional area is the width multiplied by the depth. Manning's equation for open channel flow can be expressed as:

$$Q = C/n (A/P)^{2/3} S^{1/2} A$$

Substituting width times depth w x d, for area, and width, w, for the wetted perimeter:

$$Q = C/n ((w d) / w)^{2/3} S^{1/2} w d$$

Simplifying:

$$Q = C/n d^{5/3} S^{1/2} w$$

Solving for depth, d:

$$d = (Q n) / (C S^{1/2} w)^{0.6}$$

QR represents river discharge in the program, AN the Manning coefficient of friction, BWID is the river bottom width, and RSLP is the energy gradient. Initial river depth is calculated for a river reach by the simplified Manning equation in the program as (Figure 27):

$$D = (QR * AN / (C * (RSLP^{0.5}) * BWID))^{0.6}$$

The estimated value of D is then substituted in Manning's formula for a trapezoidal channel to calculate QREST. The program first calculates the cross-sectional area, XA, of the channel. The length of the side of the channel that extends past the bottom width is calculated by dividing the depth, D, by the slope of the side of the channel, SIDE (Figure 28). The depth multiplied by this length and added to the bottom width multiplied by the depth (D * BWID) is the total cross-sectional area of flow in the channel. The cross-sectional area, XA, for a river reach becomes:

$$XA = D * BWID + (D^{2.0}) / SIDE$$

The wetted perimeter is calculated by adding the bottom width (BWID) of the channel to the length of the sloping side of the channel multiplied by two for both sides. The length of the sloping side is determined by the Pythagorean theorem, as:

$$\text{length of sloping side} = d (1 + (1/\tan^2 \theta))$$

Tangent θ is represented by SIDE in the program, and the equation for the length of the sloping side in the program is:

Manning Equation for Open Channel Flow Rectangular Channel

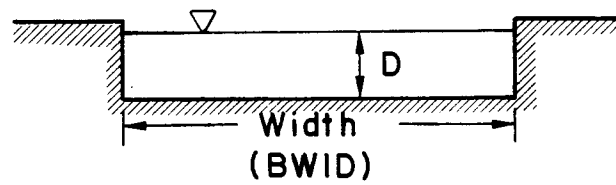

Assumption: width much greater than depth

$$QR = C/AN * D^{5/3} * RSLP^{1/2} * BWID$$

$$D = (QR * AN / (C * (RSLP ** 0.5) * BWID)) ** 0.6$$

Figure 27. Simplified Manning Equation

Manning Equation for Open Channel Flow Trapezoidal Channel

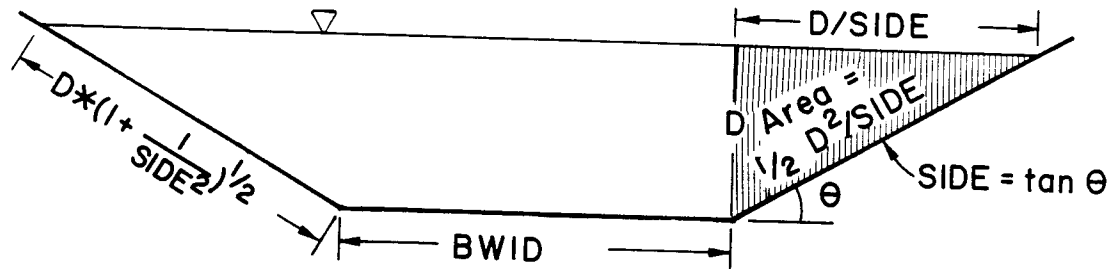

$$Q_{REST} = C / AN * (XA/P)^{2/3} * RSLP^{1/2} * XA \text{ (cms or cfs)}$$

- C - Manning Coefficient, 1.0 if metric units, 1.49 if english units
- AN - Manning Coefficient of roughness
- RSLP - Energy gradient of river
- XA - Cross sectional area of channel
 $XA = D * (BWID) + D^2/SIDE$
- P - Wetted perimeter
 $P = D * (1 + \frac{1}{SIDE^2}) * 2 + BWID$

Figure 28. Manning's Equation for a trapezoidal channel

$$D * \text{SQRT}(1.0 + (1.0 / (\text{SIDE}^{**2.0})))$$

The equation for the wetted perimeter, P, for a river reach is:

$$P = \text{BWID} + (2.0 * D * \text{SQRT}(1.0 + (1.0 / \text{SIDE}^{**2.0})))$$

Substituting XA and P into the Manning formula for open channel flow in a trapezoidal channel, the equation for the estimated discharge becomes (Figure 28):

$$\text{QREST} = C / \text{AN} * ((\text{XA} / \text{P})^{**2/3}) * (\text{RSLP}^{**0.5}) * \text{XA}$$

The user may specify the tolerance criteria to be used in the depth calculation. The program will default to a value of 0.1 (10%) for DTOLD if the user does not enter a value. A value of 0.1 specifies that the river depth estimate must produce a value of QREST that will be plus or minus 10% of the calculated value, QR. If the value of river flow is not within that range, the depth estimate will be increased or decreased by 10% of its value. For example, if a river depth produces a value of QREST that is too high, the depth will be decreased by 10% for the next time through the loop. If the river depth produces a value of QREST that is too low, the depth will be increased by 10% for the next time through the loop. The loop will continue until QREST is within the tolerance range, or the maximum number of iterations is reached. The number of iterations, ITRD, can be specified by the user in the input. Otherwise, the value of ITRD defaults to 20 iterations.

The new depth calculation loop may reach the maximum number of iterations before a satisfactory value of depth is calculated. If this occurs, an error message will be printed stating the value of QR, and the last values of D and QREST calculated, the tolerance criteria for the loop, and the number of iterations. The program will continue using the last calculated value of D for the river reach.

MASS BALANCE OF FLOW IN ALLUVIUM

Net inflow and outflow to the alluvium determines the change in storage in the alluvium for a given time step. These fluxes include seepage between the alluvium and bedrock, QBA, seepage between the alluvium and river, QRA, recharge, evapotranspiration, withdrawal or injection from pumping, QAPMP, flow into the alluvium from a reach which may be outside of the groundwater model area, QAO, flow into the alluvium from upstream reaches, QAUP. If the alluvium goes dry during a simulation, the pumping rate is set to zero.

Recharge is in units of length over time and the volume of recharge per unit time is calculated by multiplying the rate of recharge times the area of the alluvium:

$$\text{QARCH} = \text{RCHAL} * \text{ALNG} * \text{WIDA}$$

Evapotranspiration (ET) is assigned the maximum ET rate when the head is at the ground surface and decreases linearly to a user specified to an extinction depth. Required input includes: surface elevation, SURFAL, extinction elevation, EXELAL, and the maximum ET rate in units of L/T, EVTRAL. If the head in the alluvium is greater than or equal to the surface elevation, the ET rate is the maximum ET rate. If the head in the alluvium is below the ET extinction elevation, the ET rate is zero. If the head in the alluvium falls somewhere between these two elevations, the ET rate is calculated as:

$$\text{QAET} = \text{EVTRAL} * (\text{HAL} - \text{EXELAL}) / (\text{SURFAL} - \text{EXELAL})$$

Seepage into the alluvium from an upstream reach, QAUP, and seepage out of the alluvium at the downstream end, QADN, are calculated in the program using Darcy's law:

$$Q = K i A$$

where:

Q = average flow

K = the equivalent hydraulic conductivity of the adjoining reaches

i = gradient of flow into the alluvium

A = cross-sectional area of flow of the alluvium

Cross-sectional area of the alluvium is a function of the head in the alluvium in the last time step. Saturated thickness is (HAL-ABOT), and is multiplied by the width of the alluvium, WIDA, to determine the area of seepage (Figure 29).

Values for K, i, and A, for flow from the first upstream reach is (Figure 29):

$$K = (ALNUP1 + ALNG) / (ALNUP1/AHYUP1 + ALNG/AHY)$$

where:

ALNUP1 = length of the upstream reach [L]

AHYUP1 = hydraulic conductivity of upstream reach [L]

i = ASLUP1

where:

ASLUP1 = gradient of the upstream alluvium reach [L/L]

A = (HALUP1-ABTUP1) * WDUP1

where:

HALUP1 = head in the upstream alluvium [L]

ABTUP1 = bottom elevation of the upstream alluvium [L]

WDUP1 = width of the upstream alluvium [L]

Flow entering the reach from the first upstream reach is:

$$QAUP1 = (ALNUP1+ALNG) / (ALNUP1/AHYUP1 + ALNG/AHY) * ASLUP1 * (HALUP1-ABTUP1) * WDAUP1$$

If there is more than one upstream reach, the program will calculate QAUP2 and QAUP3 for LUP2 and LUP3. If there are no other upstream reaches, these values will be zero. QAUP1, QAUP2, and QAUP3 are accumulated into one value, QAUP. This value is added in to the mass balance for the alluvium.

Values for K, i, and A for flow from the alluvium into the downstream reach are (Figure 29):

$$K = (ALNGDN + ALNG) / (ALNGDN /AHYDN + ALNG/AHY)$$

where:

ALNGDN = length of the downstream reach [L]

AHYDN = hydraulic conductivity of downstream reach [L/T]

i = ASLP

where:

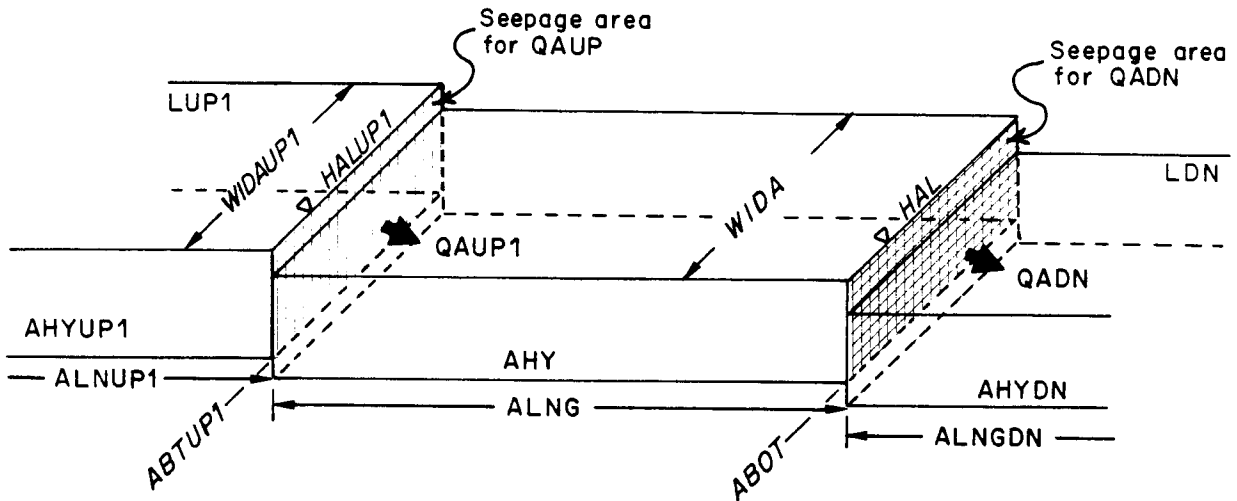

Flow from upstream reach:

$$QAUP1 = (ALNUP1 + ALNG) / (ALNUP1/AHYUP1 + ALNG/AHY) \\ * ASLUP1 * (HALUP1 - ABTUP1) * WDAUP1$$

Flow into downstream reach:

$$QADN = (ALNGDN + ALNG) / (ALNGDN/AHYDN + ALNG/AHY) \\ * ASLP * (HAL - ABOT) * WIDA$$

Figure 29. Discharge through alluvium

ASLP = gradient of the alluvium reach [L/L]

$$A = (HAL-ABOT) * WIDA$$

where:

HAL = head in the alluvium [L]

ABOT = bottom elevation of the alluvium [L]

WIDA = width of the alluvium [L]

Average flow leaving the alluvium reach is:

$$QADN = \frac{(ALNGDN + ALNG)}{WIDA} * \frac{(ALNGDN/AHYDN + ALNG/AHY)}{ASLP} * (HAL-ABOT)$$

QADN is subtracted from the mass balance equation for the alluvium.

Change in flow in the alluvium is calculated by summing all flows into and out of the alluvium for a given time step:

$$DQA = QRA - QAB + QAUP - QADN + QARCH + QAET + QAPMP + QAO$$

A new head in the alluvium is calculated as:

$$HALNEW = SYA * DQA * DELT / (WIDA * ALNG) + HAL$$

where:

SYA = specific yield of the alluvium [dimensionless]

DELT = length of the time step [T]

If the head in the alluvium is less than the bottom elevation of the alluvium, an error message is printed, and the head in the alluvium is set to the bottom elevation of the alluvium. The new head is reassigned to the variable HAL at the end of each simulation.

OUTPUT

Output for reaches containing only rivers includes location of the reach in the groundwater grid, river discharge, stage, and seepage rate. Output for reaches simulating river and alluvium include reach location, river discharge, stage, and seepage rate between the river and the alluvium, head in the alluvium and rate of seepage between the alluvium and the bedrock.

PART II PRELIMINARY RIVINT APPLICATION

APPLICATION OF RIVINT TO A PRELIMINARY MODEL OF THE DENVER BASIN

Development of this river module (RIVINT) to enhance the capabilities of the widely used and accepted U.S. Geological Survey code MODFLOW was inspired by the need for improved modeling of groundwater/surface water interaction in the Denver Basin is driven by legislation. Passage of Senate Bill 5 (1984-1985 session of the Colorado State Legislature) has presented a major challenge to the technical community faced with the tasks of implementing and enforcing the law. The purposes of Senate Bill 5 were to establish a formal definition of non-tributary ground water and clarify requirements for obtaining permits for non-tributary wells.

Special provisions were written into the Bill for defining non-tributary water in the Denver Basin. A substantial amount of development has occurred in the Denver Basin over the last few decades resulting in significant stress on the effectively non-renewable, bedrock water supply. The Denver Basin is a layered bedrock aquifer system. In all but the uppermost aquifer, artesian conditions presently prevail, except near the outcrops and in isolated areas of heavy pumping. However, one of the special provisions of Senate Bill 5 requires that for the purposes of determining areas of non-tributary ground water in the Denver Basin, water table conditions be assumed throughout each aquifer.

These special provisions present a problem to the technical community because the legal hydrologic description prescribed by the Bill does not match the actual hydrologic system in the Basin. Since the bedrock aquifer geometry is concave upward, if one assumes water table conditions, heads would be such that ground water will flow toward the center of the Basin and equilibrium cannot be established. In order to cope with this, the state hydrologists were forced to use a false geometry where the top of each aquifer is flat. Hence, the management tool for determining non-tributary wells is very different than the hydrologic system being modeled. In addition to this deformed geometry, other simplifications were incorporated into the model. For example, each aquifer was modeled as an independent two dimensional flow system and the rivers and streams were simulated as having fixed stage. Such a configuration limits evaluation of mass balance for flow in the streams and inhibits calibration. The state engineer's office had to make these simplifications to abide by Senate Bill 5 as well as to alleviate both labor and computer time involved in the project. However, the resulting delineation of non-tributary areas are based on unrealistic representations. Some of the simplifications will result in underestimates of stream depletion and others will result in overestimates. The direction of error will vary in space depending on the relevant setting and stresses, so it cannot be argued that the sum of the simplifications lead to a conservative result. The computed non-tributary area boundaries are continually challenged by current and potential groundwater users.

Development of the RIVINT code and the Denver Basin model are a first step in evaluating the short comings of the current non-tributary area delineation. Detailed analysis of the tributary areas must be conducted, but is beyond the scope of this project. Availability of a more realistic model of groundwater flow and surface water/groundwater interaction in the Denver Basin will not only improve delineation of non-tributary areas, but will also be a valuable tool in predicting the impacts of alternative management schemes.

The preliminary simulation of the Denver Basin presented herein is based on the model developed by Banta (1989). Banta's grid, material properties, and boundary conditions were used as a basis for this simulation and alluvium and rivers were added to the grid. Only minor modifications of Banta's data set were required to obtain an operable model of the basin once the rivers were simulated in more detail. However, numerous problems were encountered with calibration of the model and an improved model should be developed and calibrated before application to water management problems in the Denver Basin. In general the solution to these problems includes: 1) closer calibration of the bedrock flow system originally presented by Banta (1989) because river flows are substantially impacted by discrepancies between bedrock and field heads which in some areas are as great as 300 feet, 2) refinement of the original grid to allow more detailed simulation of river areas; 3) field measurement of parameters pertinent to surface water-

groundwater interactions (e.g. channel geometry, river bed properties, and streamflows); and 4) thorough calibration of the model given the refined grid and improved data. These activities are beyond the scope of the current project.

Magnetic disks included with this document provide the MODFLOW code, a new MODMAIN module which dimensions the X array to cope with the Denver Basin model, the RIVINT module (Appendix B), and the data files for the preliminary simulation of the Denver Basin. For this study the code was compiled both on a 386PC using NDP which allows code to extend beyond the typical 640K limit of PC's and on an IBM AIX RS 6000 work station. An executable version of the code is included which was compiled with Microsoft fortran but the X array is dimensioned to 100000 and will not incorporate the Denver Basin model. However, this smaller code can be used to simulate rivers and their alluvium in smaller groundwater models. Description of how to run the simulations presented herein, assuming a sufficiently large executable version of the code is being used, are included in Appendix C. Use of the work station was advantageous with regard to speed of computation and accommodation of large output files for transient simulations, as well as the multi-tasking features.

CONCEPTUAL MODEL

The Denver groundwater basin is located east of the Front Range of the Rocky Mountains in Colorado and encompasses an area of approximately 6700 square miles (Figure 30). The Denver groundwater basin is part of a larger structural basin which extends into parts of western Kansas and Nebraska and portions of eastern Wyoming. Elevations in the Basin range from 4500 feet above sea level in the area east of Fort Morgan to the northeast, to 7500 feet above sea level in the area west of Colorado Springs. The climate is semi-arid averaging 11 to 18 inches of precipitation per year (Figure 31).

Five bedrock formations which supply potable water in the basin are the Dawson Arkose of Tertiary age, Denver Formation of Late Cretaceous to early Tertiary age, and the Arapahoe Formation, Laramie Formation and Fox Hills Sandstone, all of Late Cretaceous age. Some water supplies are obtained from alluvial aquifers. The bedrock formations are comprised of alternating layers of high and low hydraulic conductivity. Four principle bedrock aquifers are defined from these formations, the aquifer being that part of the formation which is water bearing. These aquifers are the Dawson aquifer, Denver aquifer, Arapahoe aquifer and Laramie-Fox Hills aquifer (Figure 32). In some places the upper 100 to 200 feet of the Pierre Shale contain water bearing units. These units are included as part of the Laramie-Fox Hills aquifer (Banta, 1989). The low hydraulic conductivity layers form confining units within the formations. The formations occur in a sequence which resembles a series of asymmetric nested bowls (Figure 33). These units are described in more detail by Banta (1989). Maps showing the geologic structure, hydrology and hydraulic characteristics of these aquifers have been published (Robson, 1981; Robson and Romero, 1981a,b; Robson and others, 1981a,b; and Robson, 1983). Geologic structure of the aquifers has been updated by Banta (1989).

Outcrops of the aquifers are the physical boundaries that define the extent of the flow system. Assuming negligible leakage from the underlying formations, the hydrologic system within the four major aquifers and the overlying alluvium can be considered a closed system. Flow is assumed to be primarily horizontal in the aquifers and vertical in the aquitards. Inflow is in the form of surface infiltration and water introduced as streamflow from the border of the basin. Inflows to the groundwater system also occur by seepage from reservoirs filled by water which is imported into the Basin. Outflow is via well withdrawals and discharge to streams and springs. Flow is generally radially outward from the southwestern area of the Basin where precipitation, topography, and hence heads, are high. Heads in the bedrock aquifers are presented in Figures 34, 35, 36, and 37. Areas in the Denver, Arapahoe and Laramie-Fox Hills aquifers where there is insufficient data to map potentiometric heads are shown as shaded areas on the maps. Alluvial aquifers serve as drains for the groundwater system (Figure 38).

The South Platte River, which originates in the mountains to the west, is the major river in the basin. The major tributaries to the South Platte originate outside of the Denver Basin. Most of the smaller

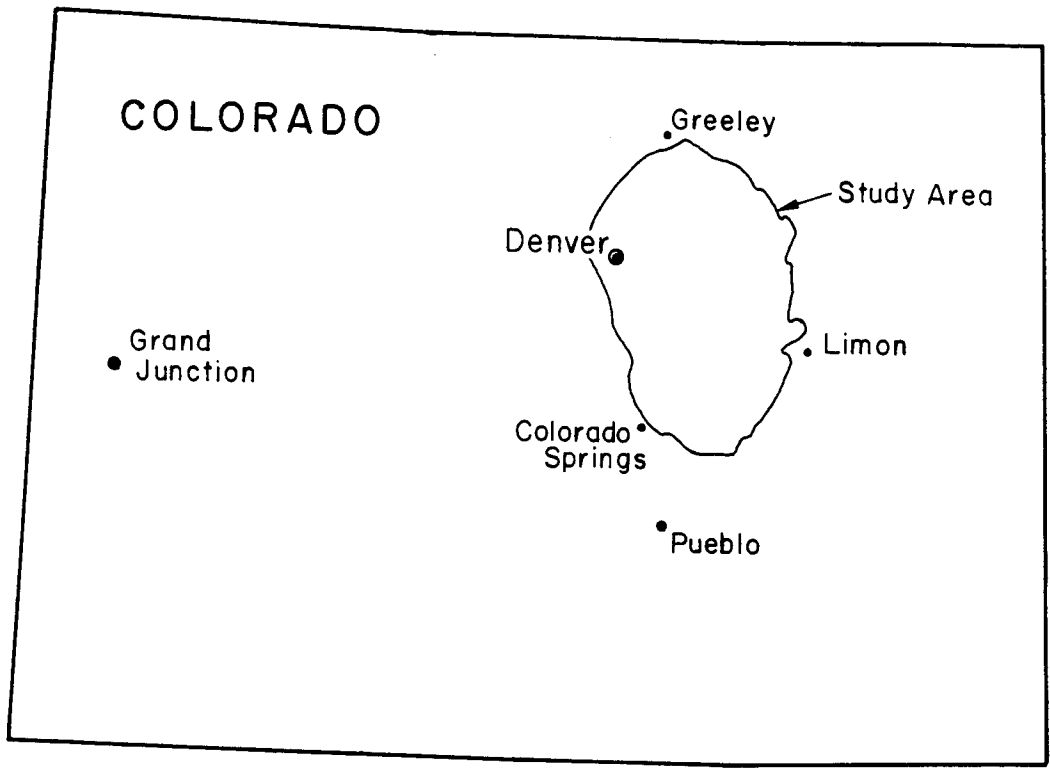

Figure 30. Denver Basin Location (after Robson, 1987)

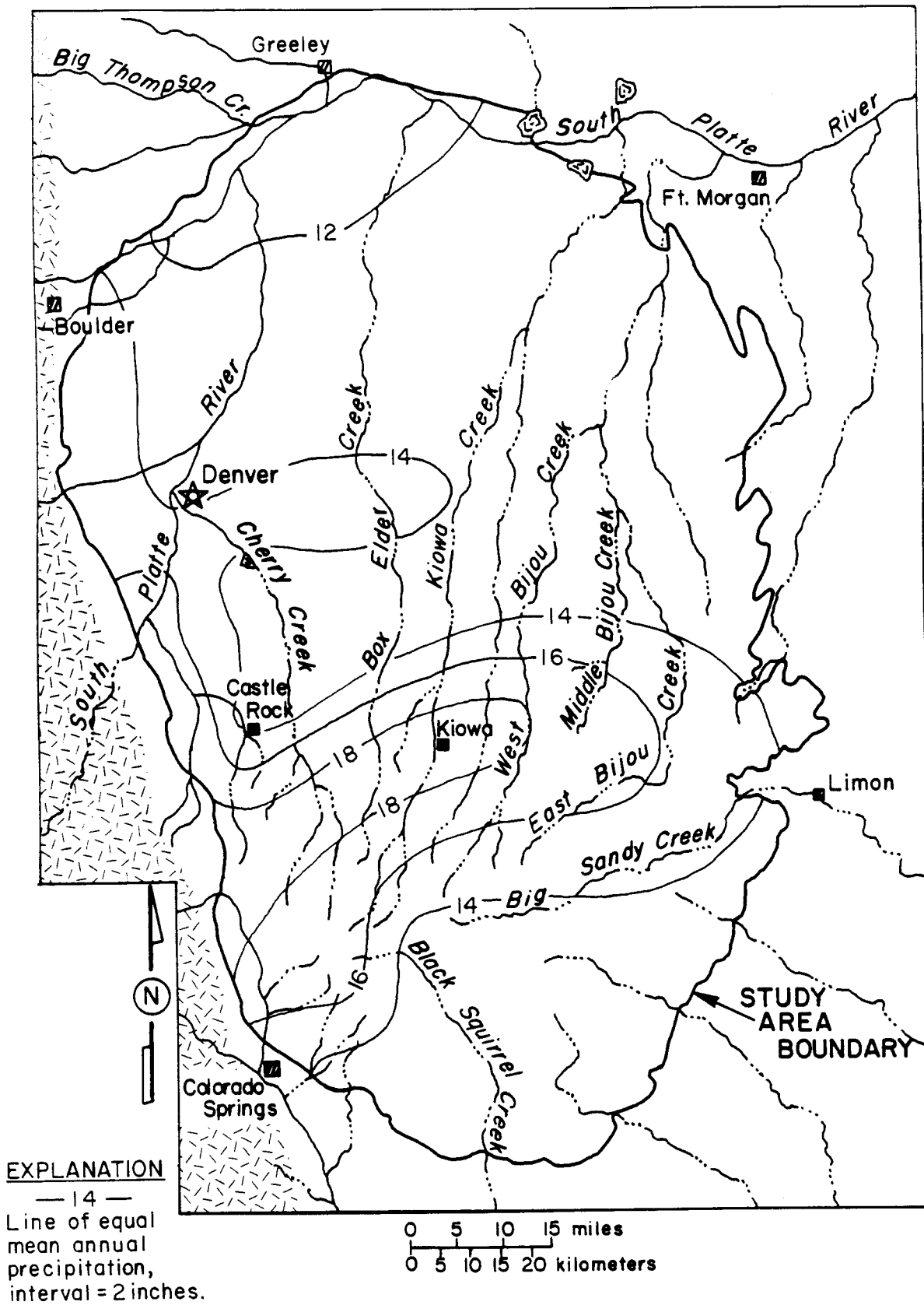

Figure 31. Distribution of precipitation (after Robson, 1987)

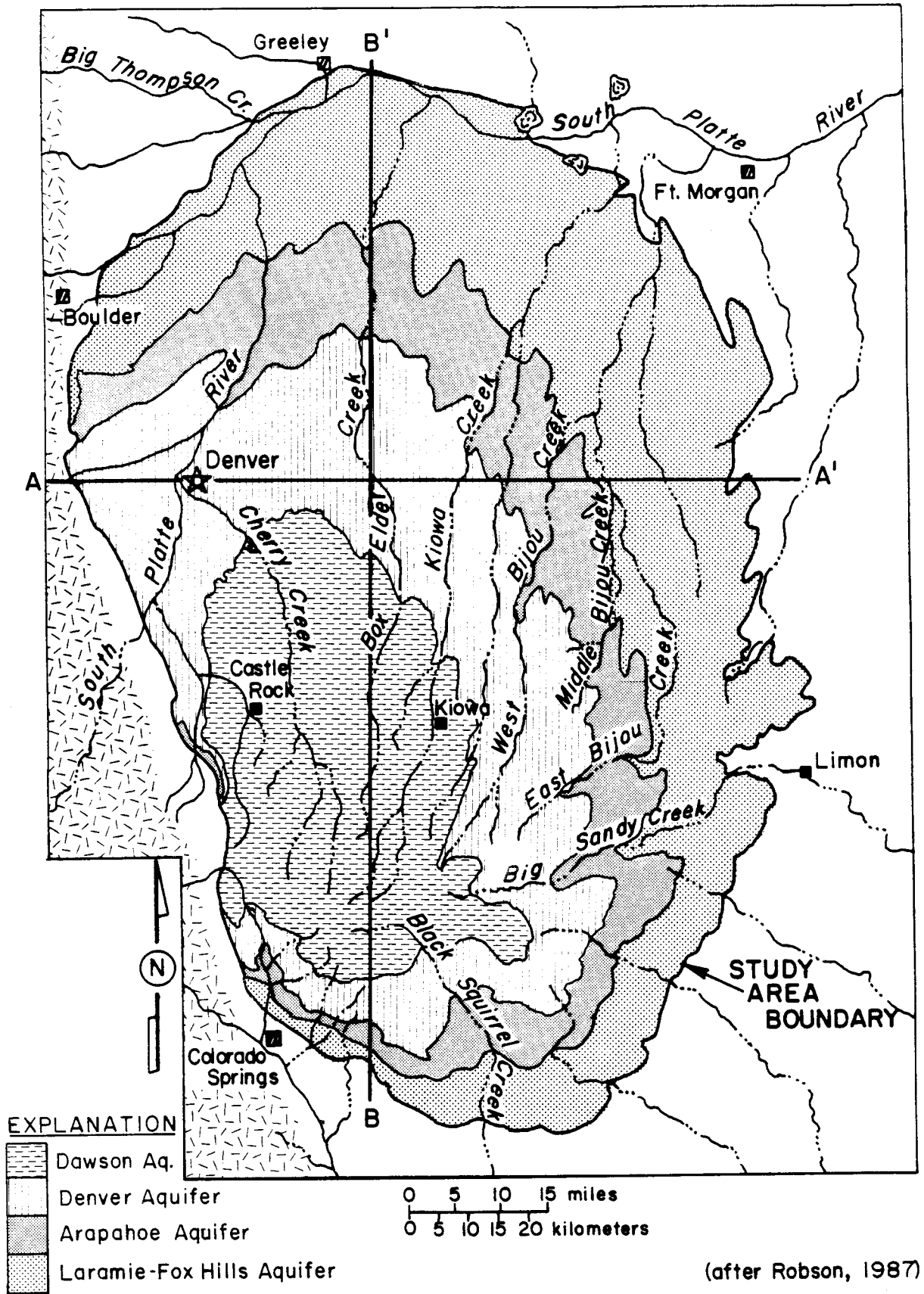

Figure 32. Principal aquifers in the Denver Basin

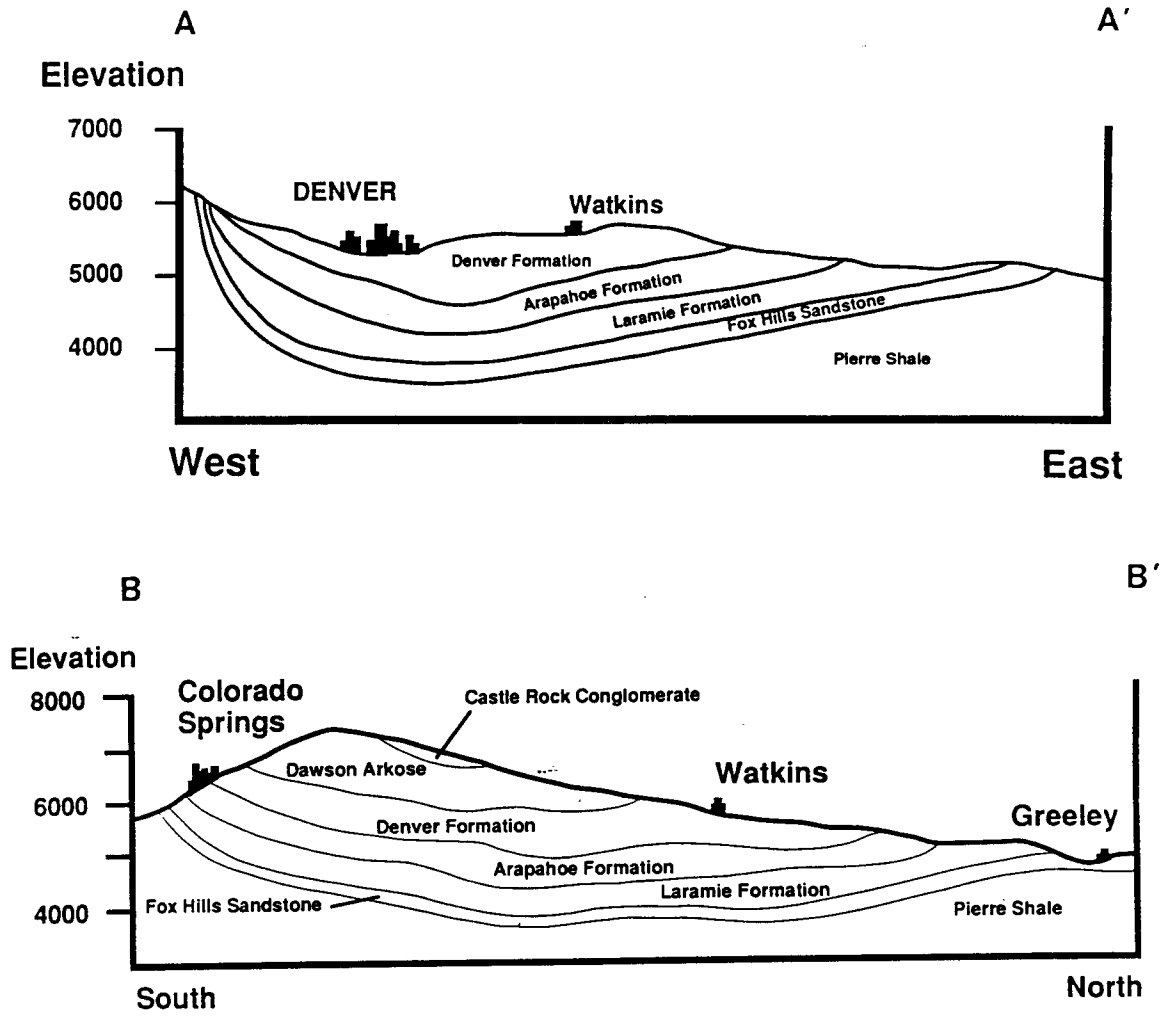

Figure 33. Schematic cross sections of the Denver Basin (after Robson, 1987)

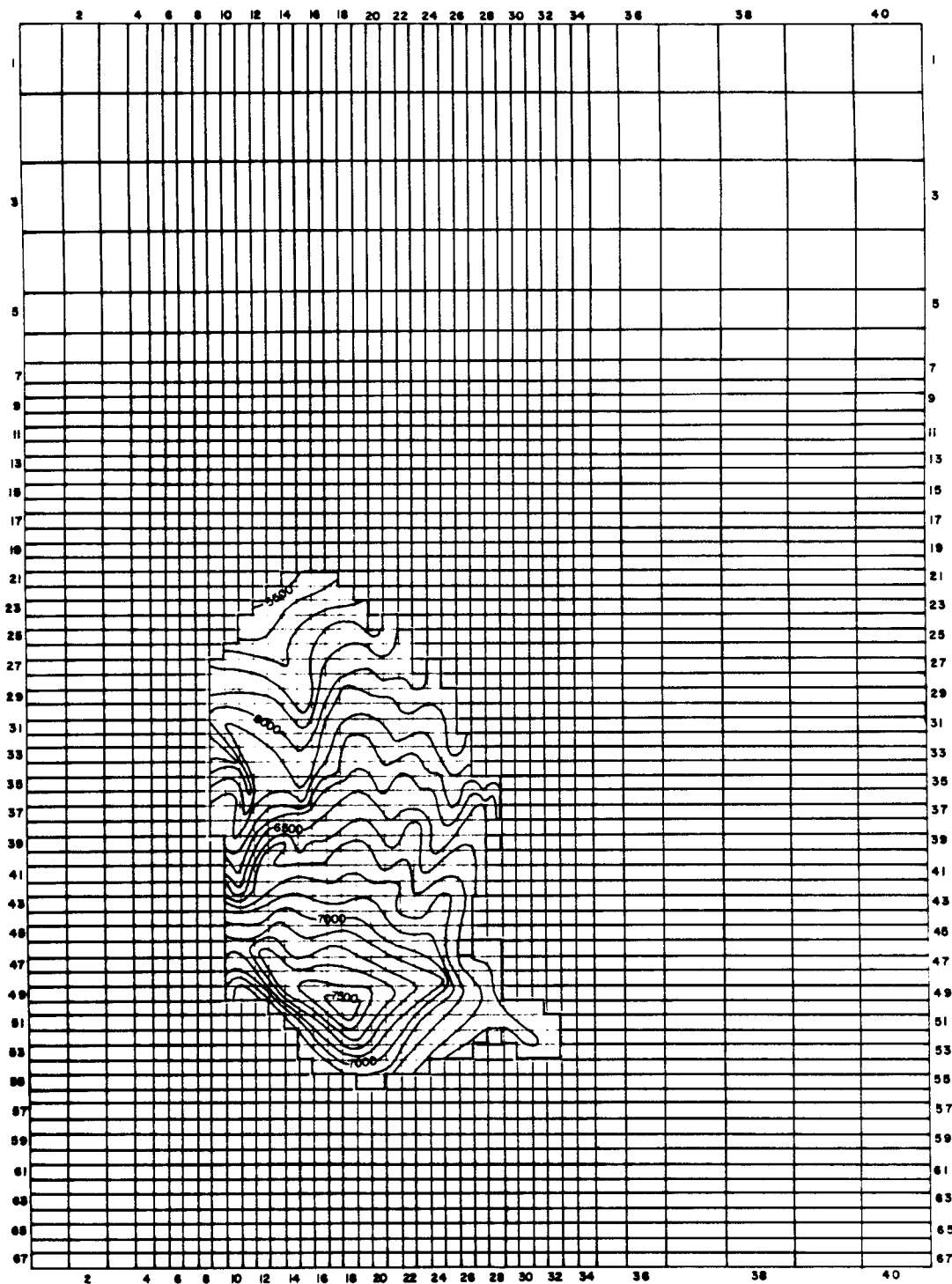

Figure 34. Measured 1978 potentiometric surface in the Dawson aquifer (after Robson, 1987)

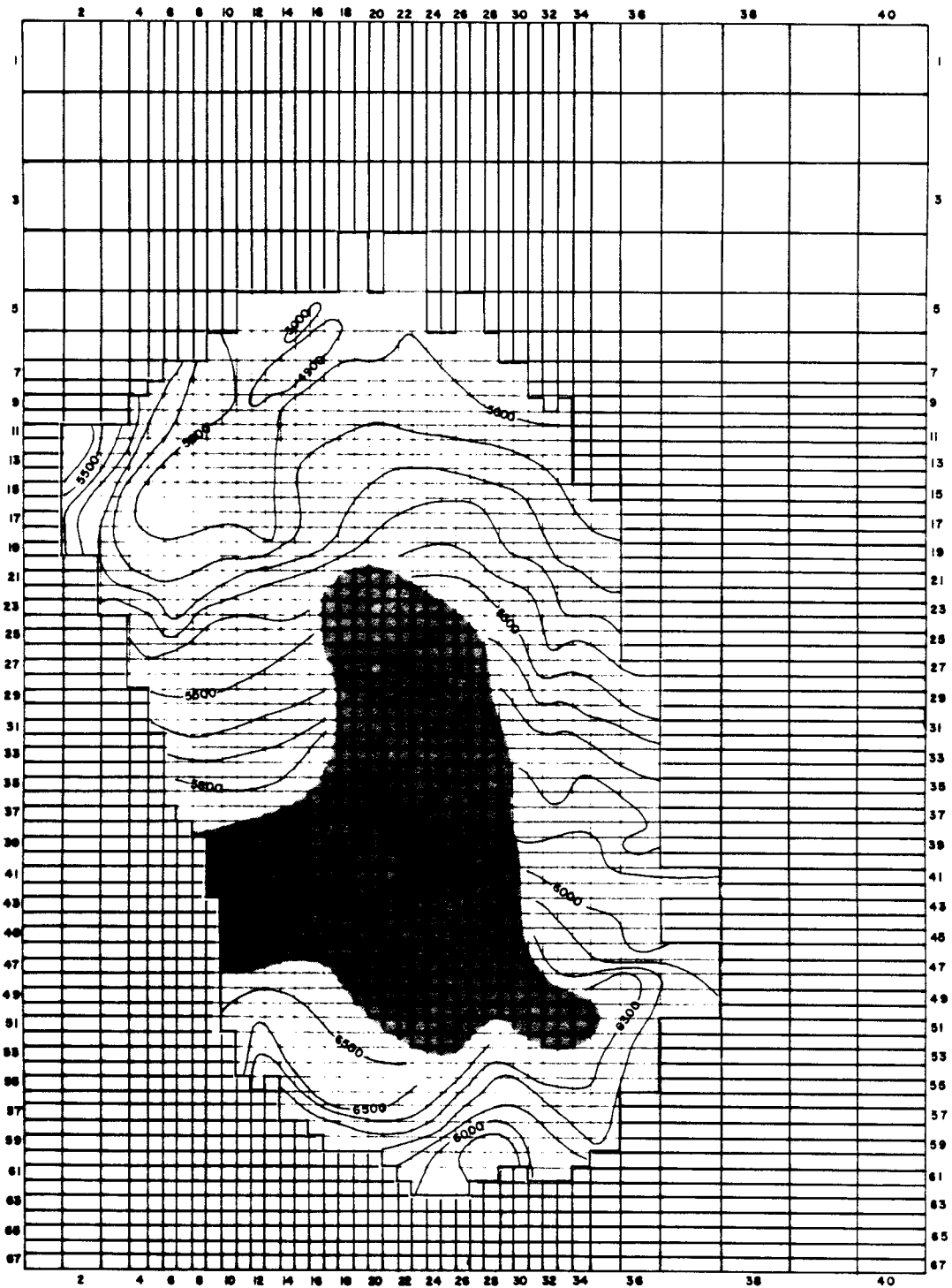

Figure 36. Measured 1978 potentiometric surface in the Arapahoe aquifer (after Robson, 1987)

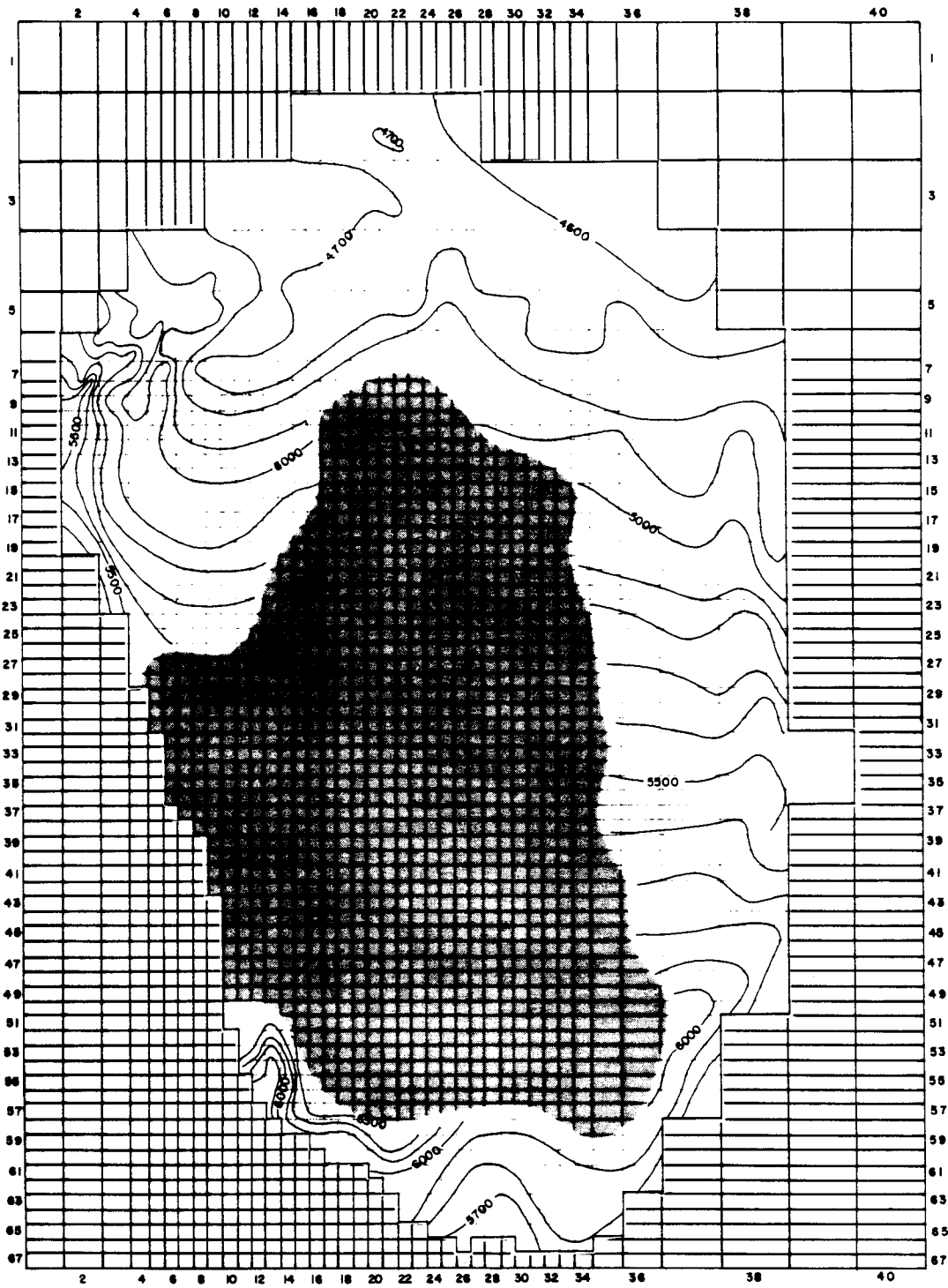

Figure 37. Measured 1978 potentiometric surface in the Laramie-Fox Hills aquifer (after Robson, 1987)

WATER LEVEL ELEVATIONS IN ALLUVIUM

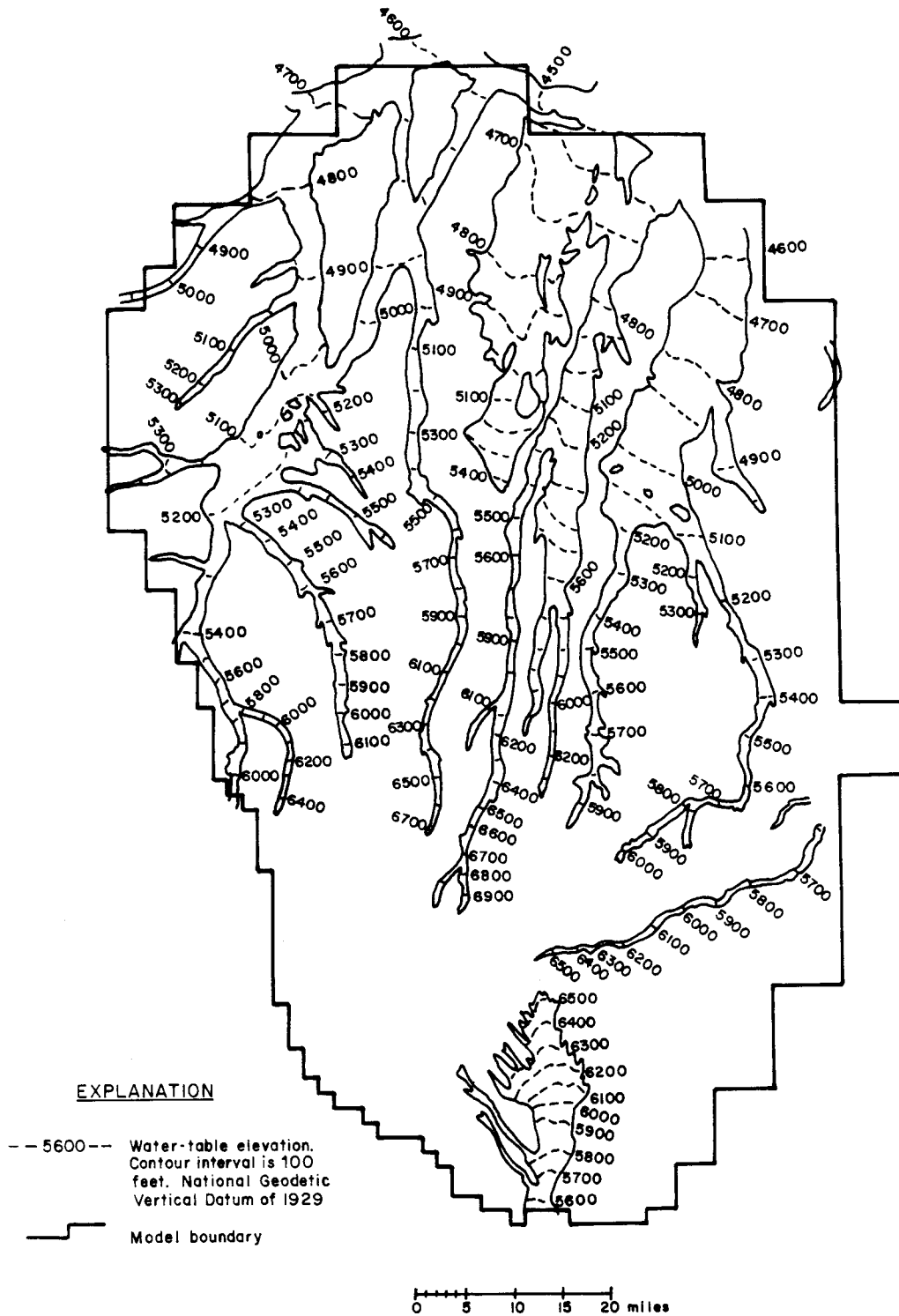

Figure 38. Measured 1978 potentiometric surface in the Alluvial aquifers (after Norris et. al., 1985)

tributaries which originate in the Denver Basin are ephemeral streams (Norris, Robson, and Parker, 1985). In the southwestern portion of the Basin, the Palmer Divide separates the northern and southern portions of the basin. Streams north of the divide flow northward into the South Platte River. Streams south of the divide flow south or southeast into the Arkansas River basin.

Data for stream discharge in Plum Creek, Cherry Creek, Kiowa Creek, St. Vrain Creek, Big Thompson River, South Platte River, and Monument Creek (Figure 39) were used in this study (Petsch, 1979; Norris and others, 1985). Data for other streams in the basin are incomplete due to loss of gaging stations during flooding events. Robson (1987) estimated that streams with an average baseflow greater than 1 cubic foot per second (cfs) include: Badger-San Arroyo, Big Sandy, Bijou, Black Squirrel, Box Elder, Cherry, Kiowa, Monument-Fountain, Plum and the South Platte River.

Robson developed a numerical model to represent the conceptual model described in this section using the U.S.G.S. three-dimensional finite-difference code written by Trescott (1975) and Trescott and Larson (1976). Banta (1989) updated Robson's model by refining the grid, and included information which became available subsequent to Robson's work. Banta also used the model by Trescott and Larson. The model grid used in the computer simulation is 40 columns by 67 rows. The conceptual model discussed above is defined in a discrete manner on the grid illustrated in Figure 40. Delineation of individual aquifers, alluvium, and rivers on the grid is shown in Figure 41. The same grid applies to all four layers of the model. The Dawson, Denver, Arapahoe, and Laramie-Fox Hills aquifers are represented by the first, (top), second, third and fourth layers respectively.

MATERIAL PROPERTIES

Input data files to MODFLOW, using RIVINT, for the simulations discussed in this report are included on the disks enclosed in this report. Banta's (1989) data files were obtained and converted to the proper format for input to the U.S.G.S. modular three-dimensional finite-difference groundwater flow code (MODFLOW) by McDonald and Harbaugh (1988). New input was incorporated into the computer data files to represent alluvial aquifers. These data were obtained from existing literature (Buckles and Watts, 1988; Hurr and Schneider, 1972; Hurr, Schneider and others, 1972; Konikow, 1975; Major, 1983).

Alluvium in the Denver Basin consists of unconsolidated sediments that are primarily sands and gravels, and may contain lenses of silt and clay (Norris and others, 1985). No attempt was made to model heterogeneities within alluvial units. Saturated thickness of the alluvial aquifers within the Basin range from less than 10 feet to more than 100 feet. Hydraulic conductivity ranges between 100 and 500 feet per day (Burns, 1980). Alluvial aquifers have high transmissivities with values up to 400 gallons per day per foot in the Greely and Weldona reaches of the South Platte river (Hurr and Schneider, 1972; Hurr, Schneider and others, 1972). The alluvial aquifer adjacent to the Rocky Mountain Arsenal has transmissivities as high as 150,000 gallons per day per foot (Konikow, 1975).

Alluvial aquifer thicknesses in the model range from 20 feet in the upstream reaches to a maximum of 60 feet in the downstream reaches. An average thickness was estimated for alluvial aquifers based on maximum thickness near the center of the alluvium and zero thickness near the edges. In areas where little or no information is available on alluvial aquifers, the saturated thickness of the alluvium was assumed to be similar to that of alluvium in similar settings in the basin. Hydraulic conductivities range from 50 ft/day to 100 ft/day. Transmissivity of alluvium modeled with grid cells is the product of thickness and hydraulic conductivity. In areas where alluvium was smaller in size than the grid cell, an estimate was made of the percentage of area occupied by alluvium. Transmissivity of the grid cell was adjusted by multiplying the estimated value by the fraction of area occupied by alluvium. Recharge for alluvium modeled as part of the model grid is generally 25% of the precipitation rate. Recharge was also adjusted by the percent of areal coverage of alluvium in the grid cell. Specific yield was assumed to be 0.1 for all alluvium.

Some of the alluvium in the Basin was simulated explicitly using the RIVINT module and some was implicitly simulated by assigning properties representing alluvium to grid cells. Alluvium in the upper

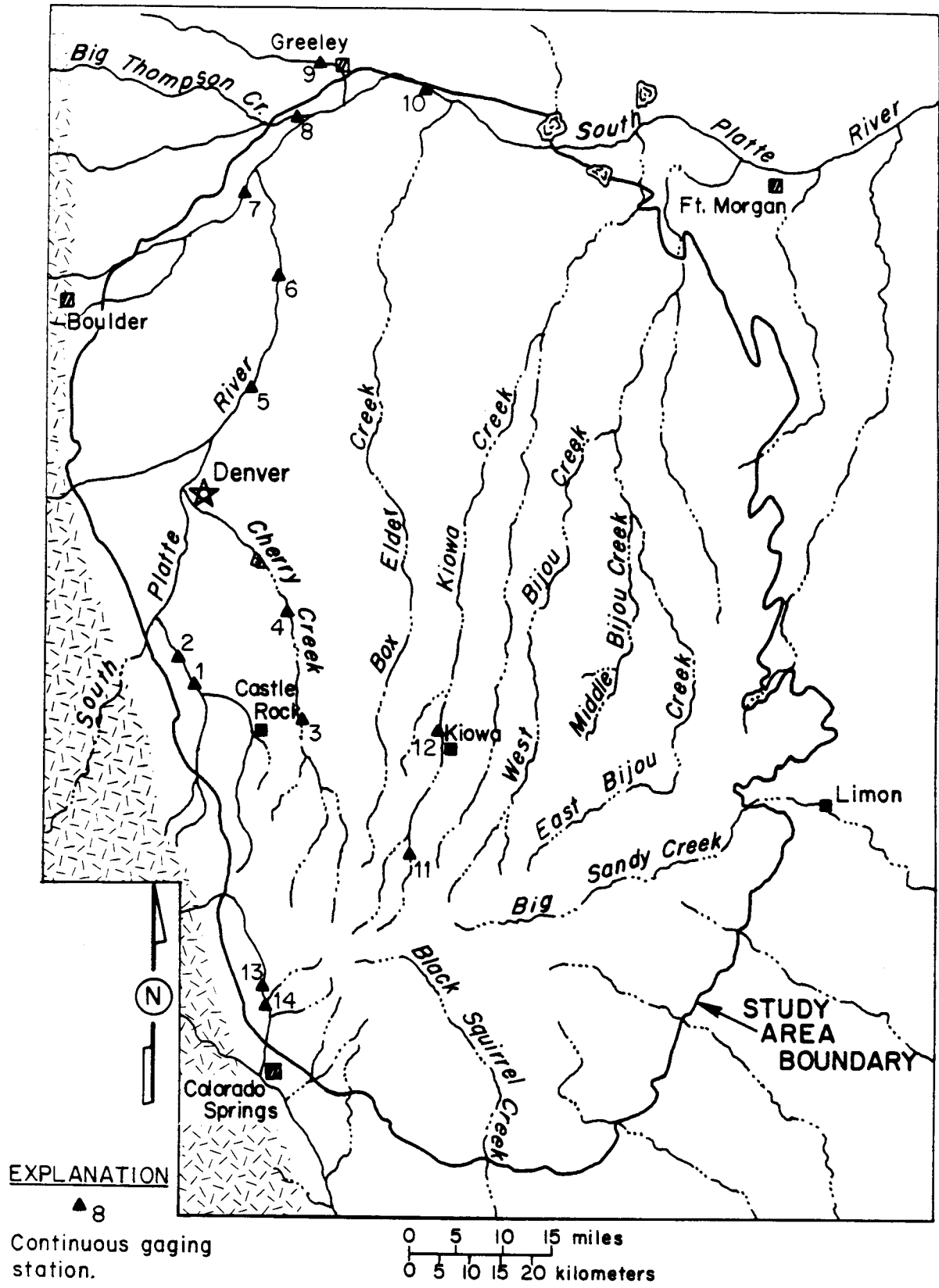

(after Robson, 1987)

Figure 39. Measured stream discharges

FINITE DIFFERENCE GRID

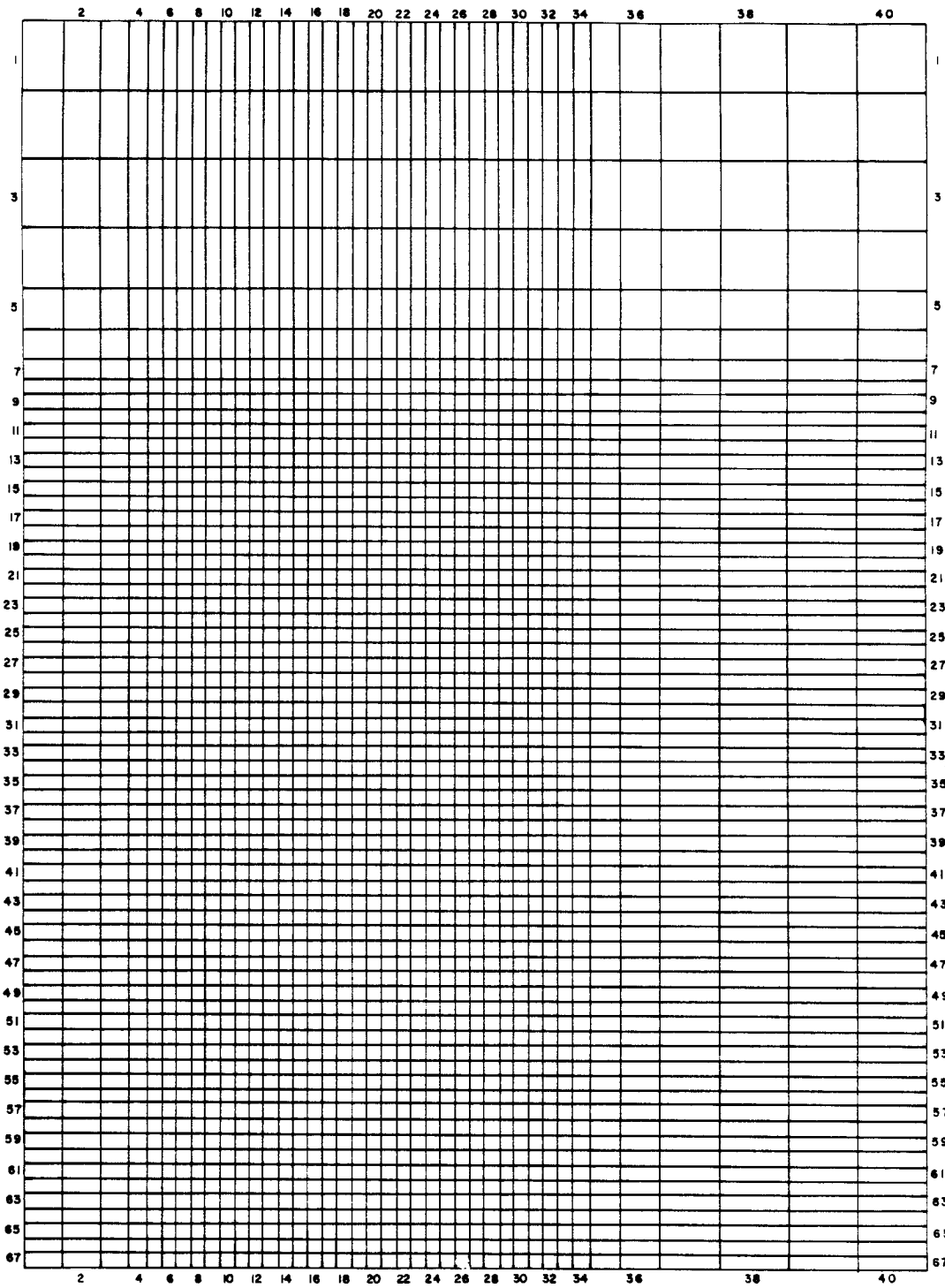

Figure 40. Finite difference grid

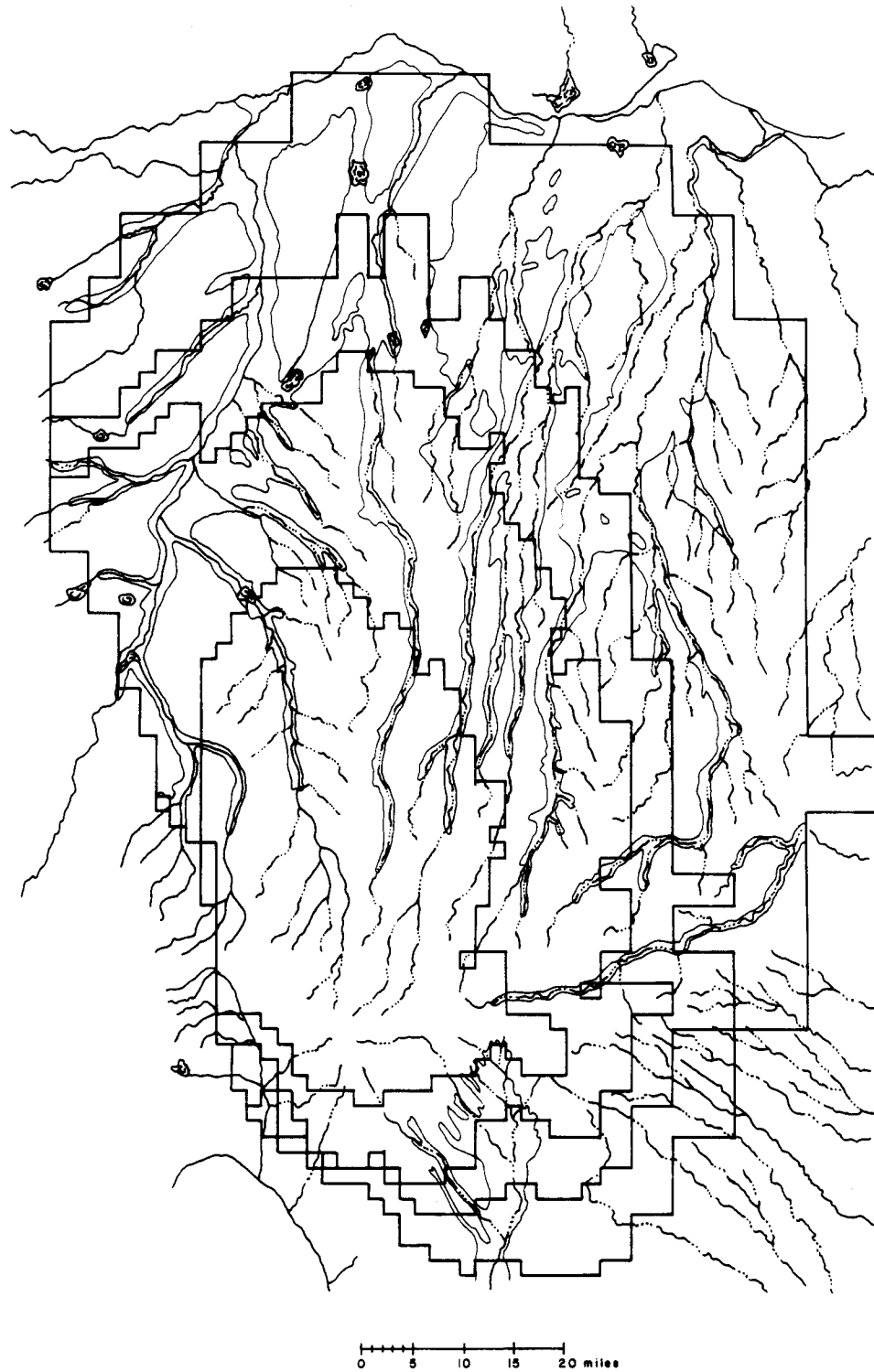

Figure 41. Geohydrologic features of grid area

reaches of Box Elder and Kiowa creeks, where they flow over the Dawson Formation, and alluvium of Big Sandy creek, where it flows over the Denver and Arapahoe Formations was explicitly modeled using the RIVINT module. In other areas, alluvium was modeled as part of the model grid either by replacing bedrock grid cell parameters with alluvial parameters within the layer representing the bedrock formation, or by adding grid cells from an overlying layer (where the younger formation does not occur) to the grid. For example, alluvium overlying the Arapahoe bedrock aquifer (which is the 3rd layer from the top in the grid) would be modeled as an additional layer 2 grid cell. Where alluvium crosses a contact between two formations, there is vertical overlap of alluvial grid cells to provide continuity in the alluvium. For example, if alluvium crosses the contact of the Arapahoe, layer 3, and the Laramie Fox-Hills, layer 4, a layer 2 alluvium grid cell is overlying a layer 3 alluvium grid cell which sits on top of a layer 4 bedrock aquifer grid cell (Figure 42). This allows continuous flow through the alluvium. Alluvium that overlies the Denver aquifer was modeled by replacing layer 2 (Denver) grid cell parameters. This was done because of mathematical instability that occurred when these alluvial cells were modeled as layer 1 grid cells. Alluvium that was not modeled includes alluvium of East Plum Creek and the upper reaches of Cherry Creek.

MODFLOW allows the user to choose from four layer types. Layer-type 3 was used for the Dawson aquifer (layer 1), and layer-type 2 was used for the Denver, Arapahoe and Laramie - Fox Hills aquifers (layers 2, 3 and 4). Layer-type 3 is for situations in which the thickness of the layer may vary significantly during a simulation. Transmissivities are recalculated at each iteration using the updated heads, hydraulic conductivities and layer bottom elevations for layer-type 3. A primary and secondary storage term is entered for each active grid cell. The primary storage coefficient is used until the head in the aquifer falls below the top elevation of the aquifer. When the head falls below the top of the aquifer, the secondary coefficient, or specific yield, is used. Therefore, for layer-type 3, the user must enter information for hydraulic conductivity, layer bottom elevation, confined storage coefficient, specific yield, vertical conductance and layer top elevation. The user has the option of using one global value for each of these parameters throughout the layer or assigning a value to each active grid cell in the layer.

Layer-type 2 is used where conditions may vary between confined and unconfined conditions, but the saturated thickness of the aquifer remains a high percentage of the total layer thickness of the aquifer throughout a simulation. The transmissivity is therefore assumed to be constant and transmissivities are not calculated with each iteration. A primary and secondary storage term is entered for each active grid cell for the same reason it is entered for layer-type 3 as described previously. For layer-type 2, the user must enter information for transmissivities, confined storage coefficients, specific yield, vertical conductance and layer top elevation.

Banta's model did not require data for the top elevation of all active grid cells in each layer because the Trescott code did not need top elevation for unconfined grid cells. Therefore, it was necessary to estimate the average top elevation for active grid cells in each layer that did not have this parameter. This was done by using Colorado county maps with a scale of 1:50,000 and overlaying a grid corresponding to the location of grid cells in the model grid. An average elevation was estimated and used as top elevation for the corresponding grid in the model.

A map of the distribution of hydraulic conductivity values for the Dawson aquifer is illustrated in Figure 43 and alluvium in Figure 44. Maps of the distribution of transmissivities of the Denver, Arapahoe, and Laramie-Fox Hills aquifers are illustrated in Figures 45, 46, and 47 respectively.

Distribution of storage coefficient for each layer is illustrated in Figures 48, 49, 50, and 51. Specific yield is used for unconfined conditions, or where the head in the aquifer falls below the top elevation of the aquifer. Values for specific yield average 0.18 for the Dawson aquifer, 0.16 for the Denver aquifer, 0.18 for the Arapahoe aquifer, and 0.20 for the Laramie-Fox Hills aquifer. A more detailed discussion of use of primary and secondary storage coefficients in MODFLOW can be found in McDonald and Harbaugh (1988).

Aquifers in the Denver basin receive recharge from infiltration where the aquifers are exposed at the surface, and from vertical leakage from overlying aquifers. Vertical leakage is relatively small compared to the horizontal flow in the aquifers. However, the large area over which vertical leakage takes place makes this an important source of inflow to deeper aquifers (Robson, 1987). VCONT is the parameter name for the term which describes conductance between layers in MODFLOW. Vertical conductance is the vertical hydraulic conductivity of an aquitard divided by its thickness. When discrete aquitards do not exist, this term

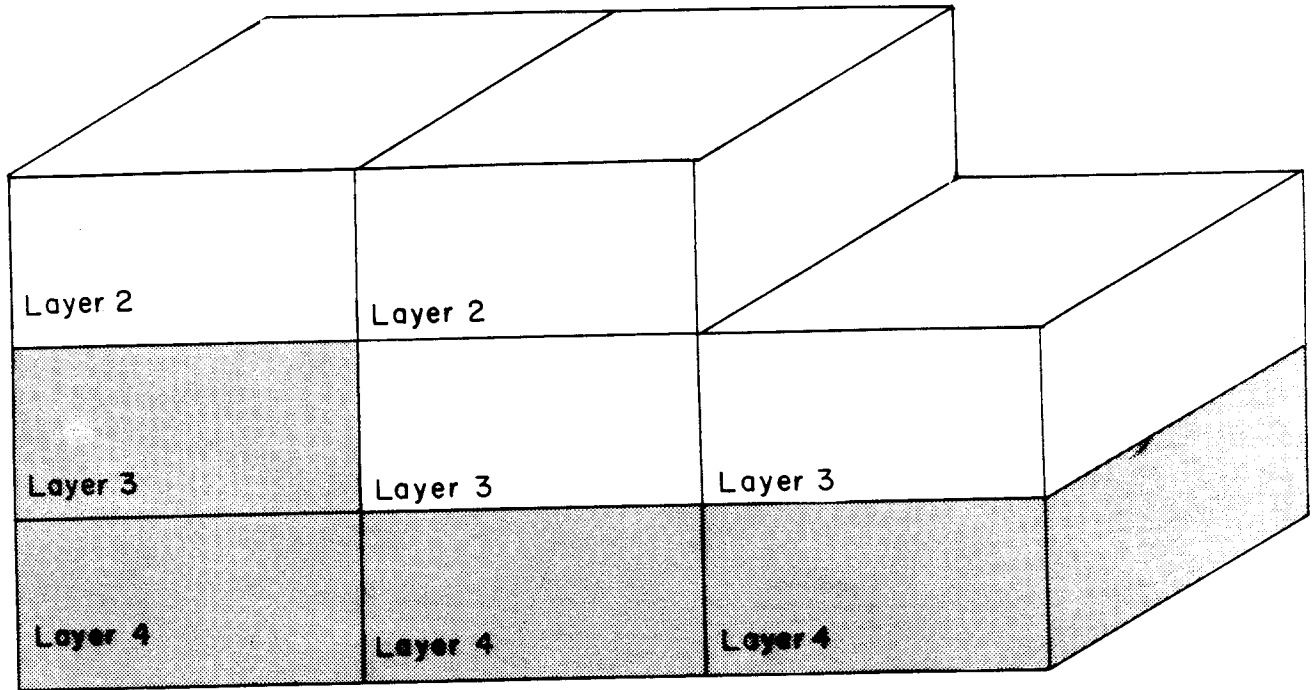



-  Grid block added as alluvium
-  Original grid block

Figure 42. Configuration of alluvium simulated as grid cells across formation contacts

HYDRAULIC CONDUCTIVITIES OF THE DAWSON AQUIFER

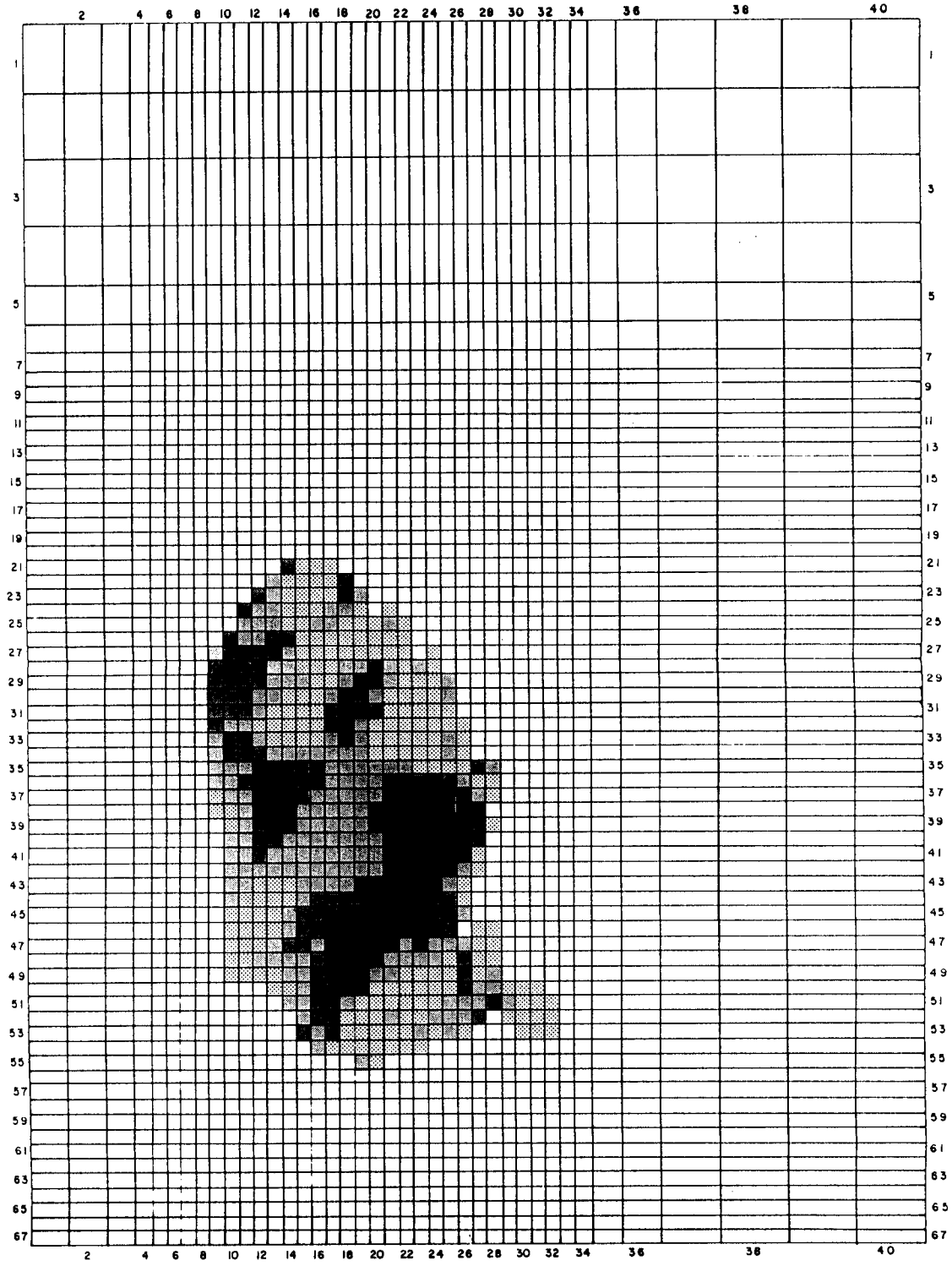

EXPLANATION

- | | |
|--|--|
| <p> $7 \times 10^{-2} \leq K < 5 \times 10^{-1}$ ft/day</p> <p> $5 \times 10^{-1} \leq K < 1 \times 10^0$ ft/day</p> <p> $1 \times 10^0 \leq K < 3 \times 10^0$ ft/day</p> | <p> $3 \times 10^1 \leq K < 1 \times 10^2$ ft/day</p> <p> $1 \times 10^2 \leq K$ ft/day</p> |
|--|--|

Figure 43. Hydraulic conductivity of the Dawson aquifer

HYDRAULIC CONDUCTIVITIES OF ALLUVIUM

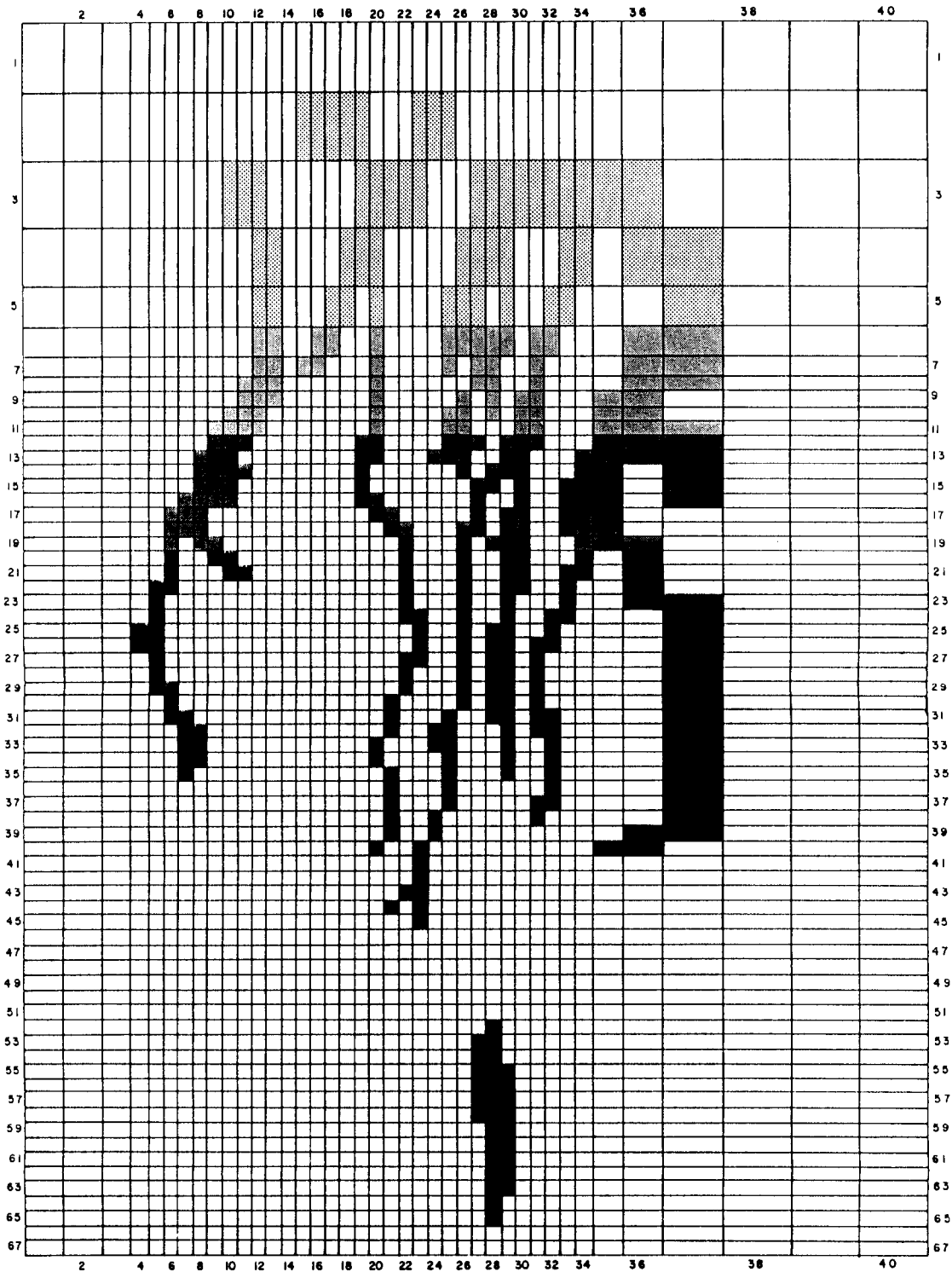

EXPLANATION

- | | |
|---|--|
| <p> 70 ft/day</p> <p> 80 ft/day</p> <p> 90 ft/day</p> | <p> 50 ft/day</p> <p> 100 - 113 ft/day</p> |
|---|--|

Figure 44. Hydraulic conductivity of the Alluvial aquifers

TRANSMISSIVITIES OF THE DENVER AQUIFER

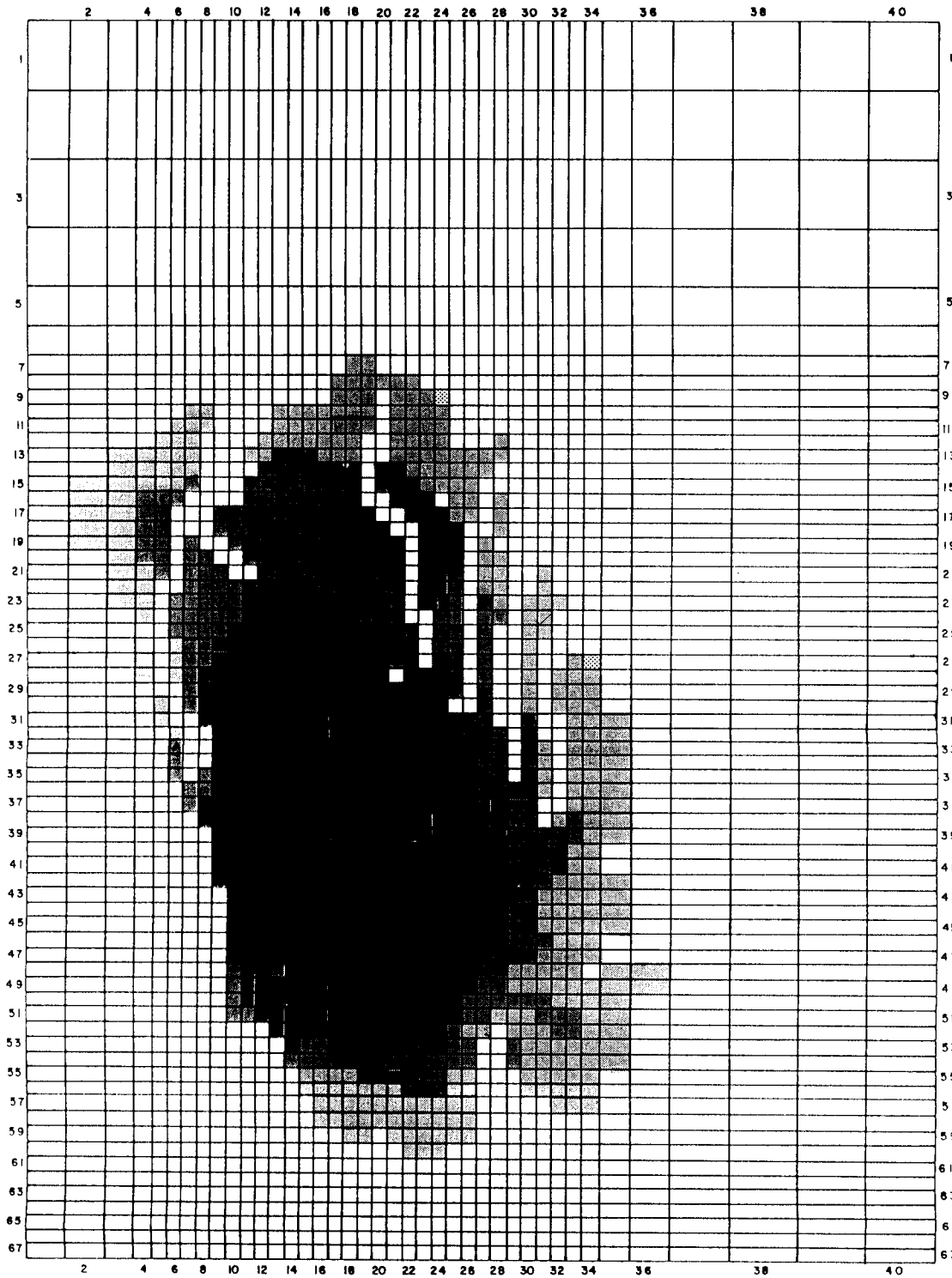

EXPLANATION

- | | |
|--|--|
| <p> $3 \leq T < 10 \text{ ft}^2/\text{day}$</p> <p> $10 \leq T < 50 \text{ ft}^2/\text{day}$</p> <p> $50 \leq T < 100 \text{ ft}^2/\text{day}$</p> | <p> $100 \leq T < 200 \text{ ft}^2/\text{day}$</p> <p> $200 < T \text{ ft}^2/\text{day}$</p> |
|--|--|

Figure 45. Transmissivities of the Denver aquifer

TRANSMISSIVITIES OF THE ARAPAHOE AQUIFER

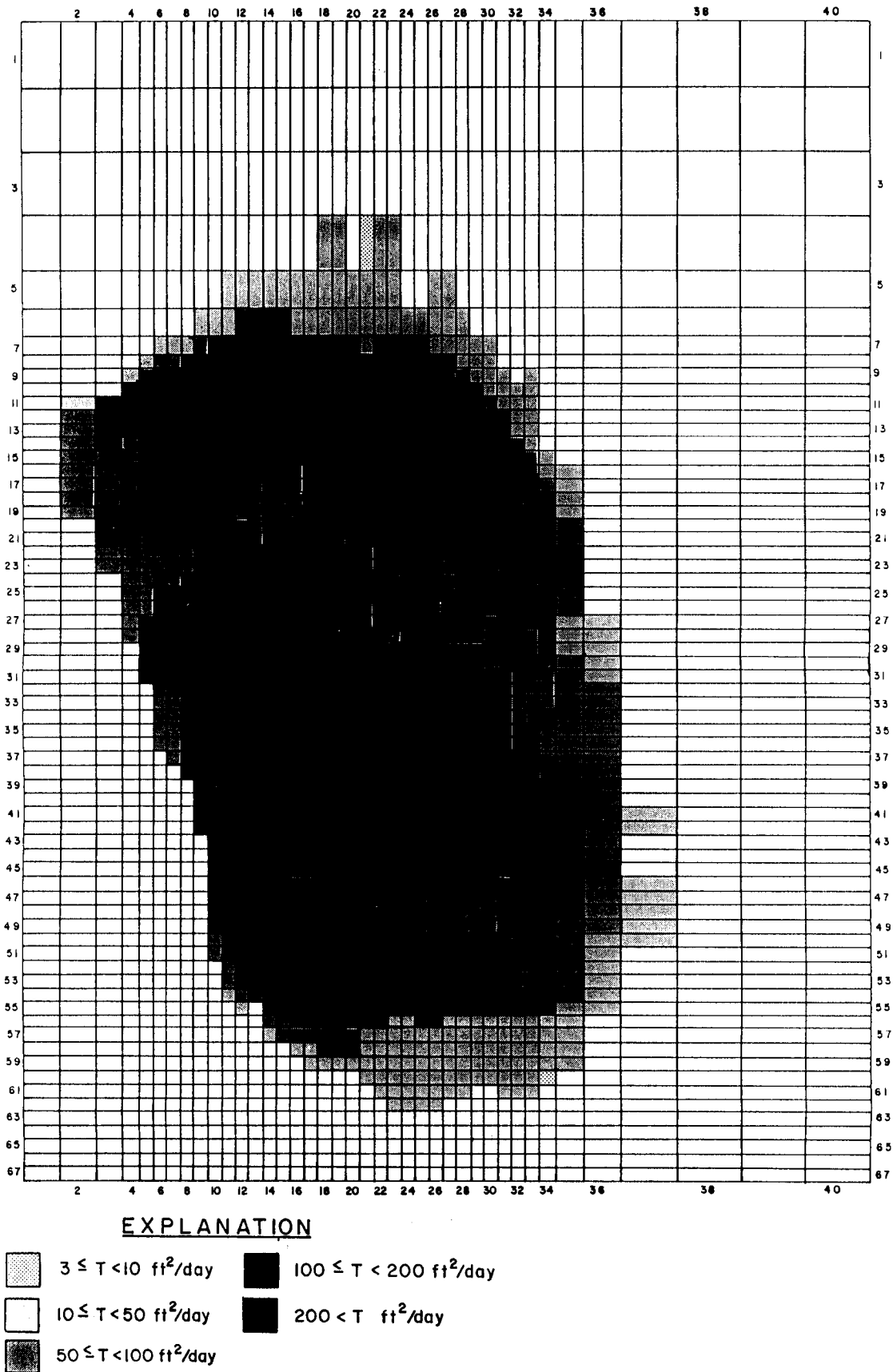
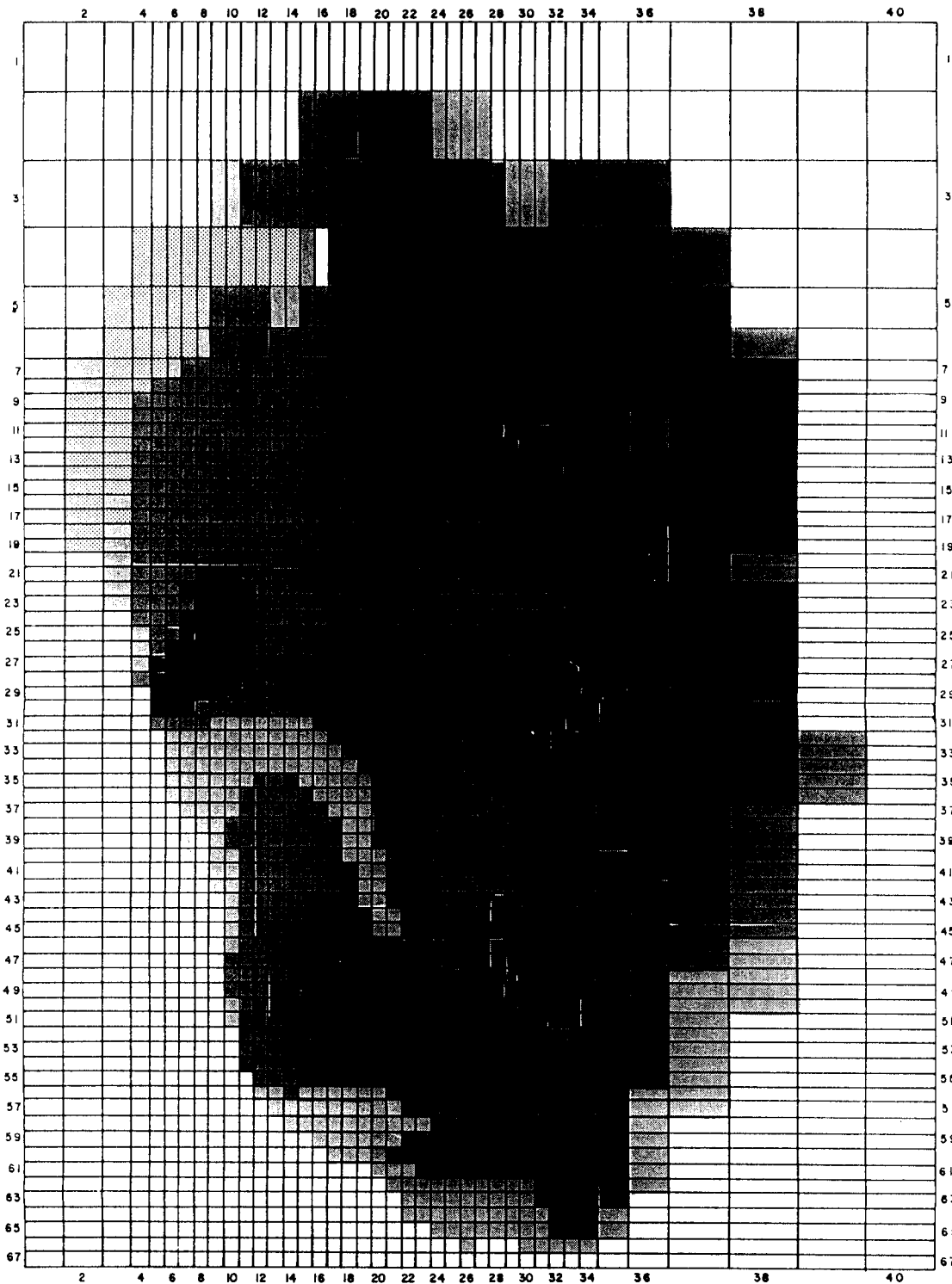

Figure 46. Transmissivities of the Arapahoe aquifer

TRANSMISSIVITIES OF THE LARAMIE-FOX HILLS AQUIFER



EXPLANATION





- | | |
|---|--|
| <p> $3 \leq T < 10 \text{ ft}^2/\text{day}$</p> <p> $10 \leq T < 50 \text{ ft}^2/\text{day}$</p> <p> $50 \leq T < 100 \text{ ft}^2/\text{day}$</p> | <p> $100 \leq T < 200 \text{ ft}^2/\text{day}$</p> <p> $200 < T \text{ ft}^2/\text{day}$</p> |
|---|--|

Figure 47. Transmissivities of the Laramie-Fox Hills aquifer

STORAGE COEFFICIENTS OF THE DAWSON AQUIFER

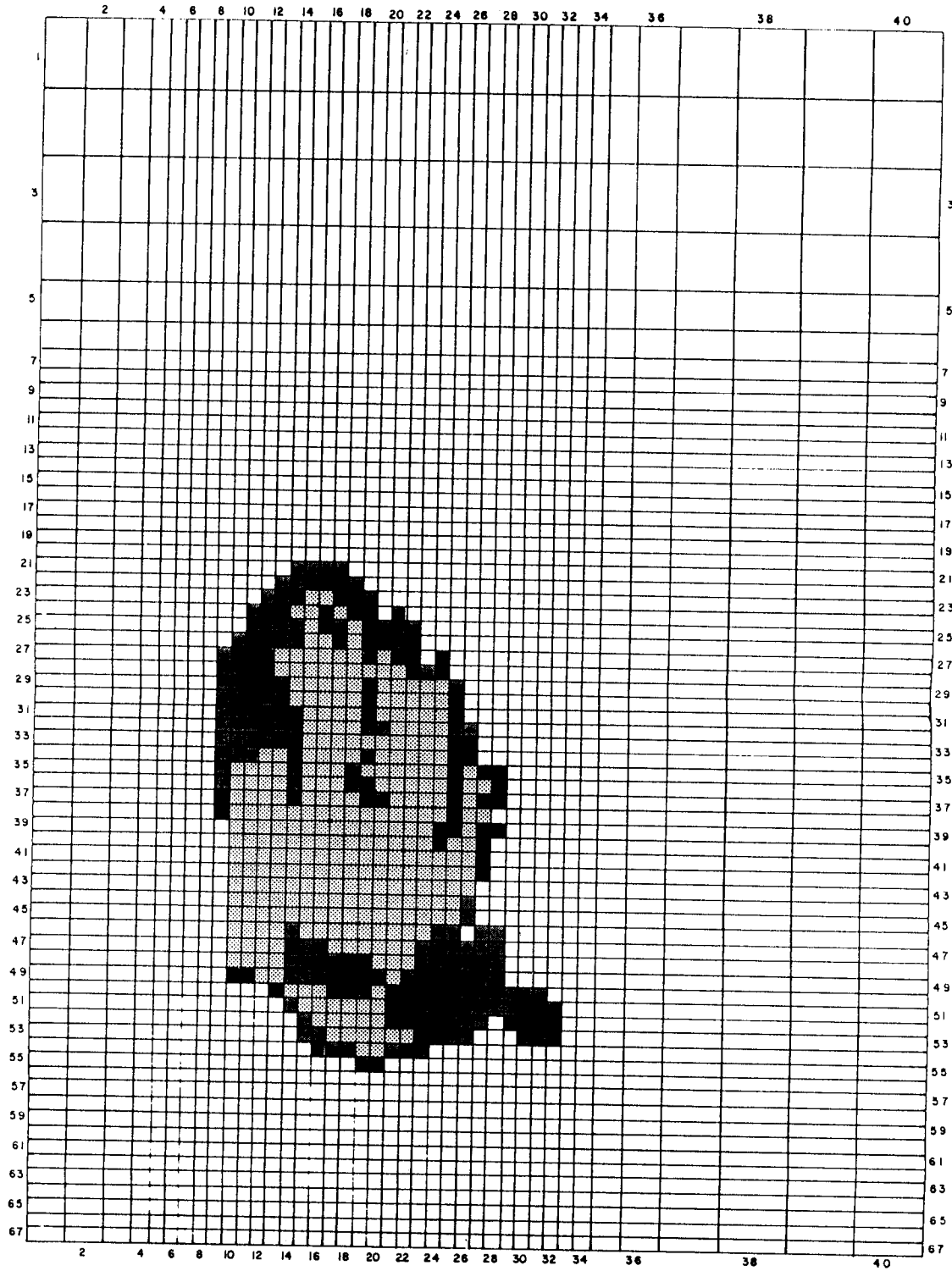

EXPLANATION

- $1 \times 10^{-4} \leq s < 1 \times 10^{-3}$
- $1 \times 10^{-2} \leq s < 1 \times 10^{-1}$
- $1 \times 10^{-1} \leq s$

Figure 48. Storage Coefficient of the Dawson aquifer

STORAGE COEFFICIENTS OF THE DENVER AQUIFER

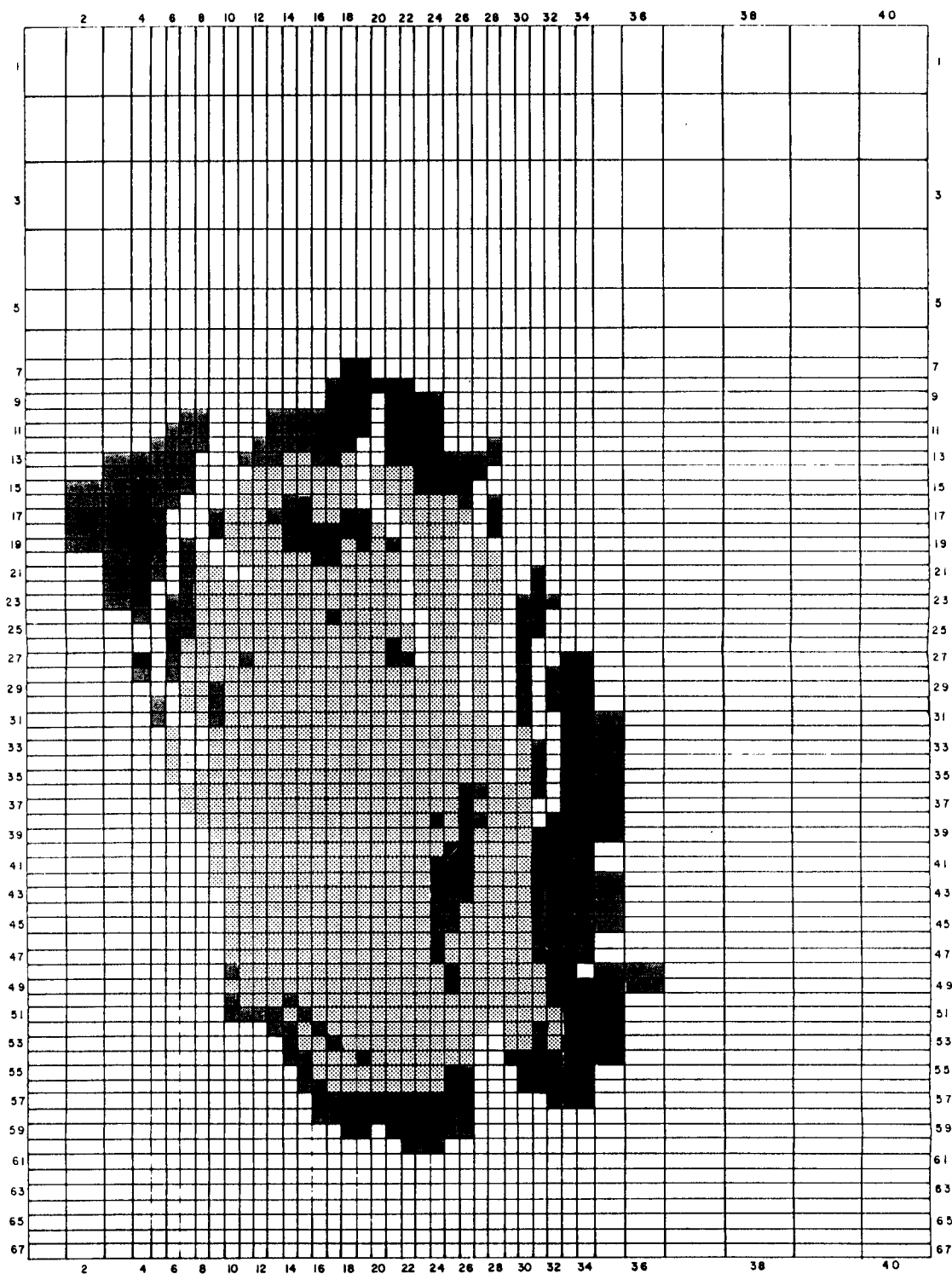

EXPLANATION

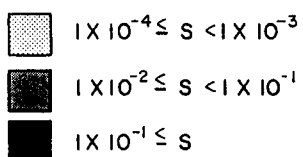
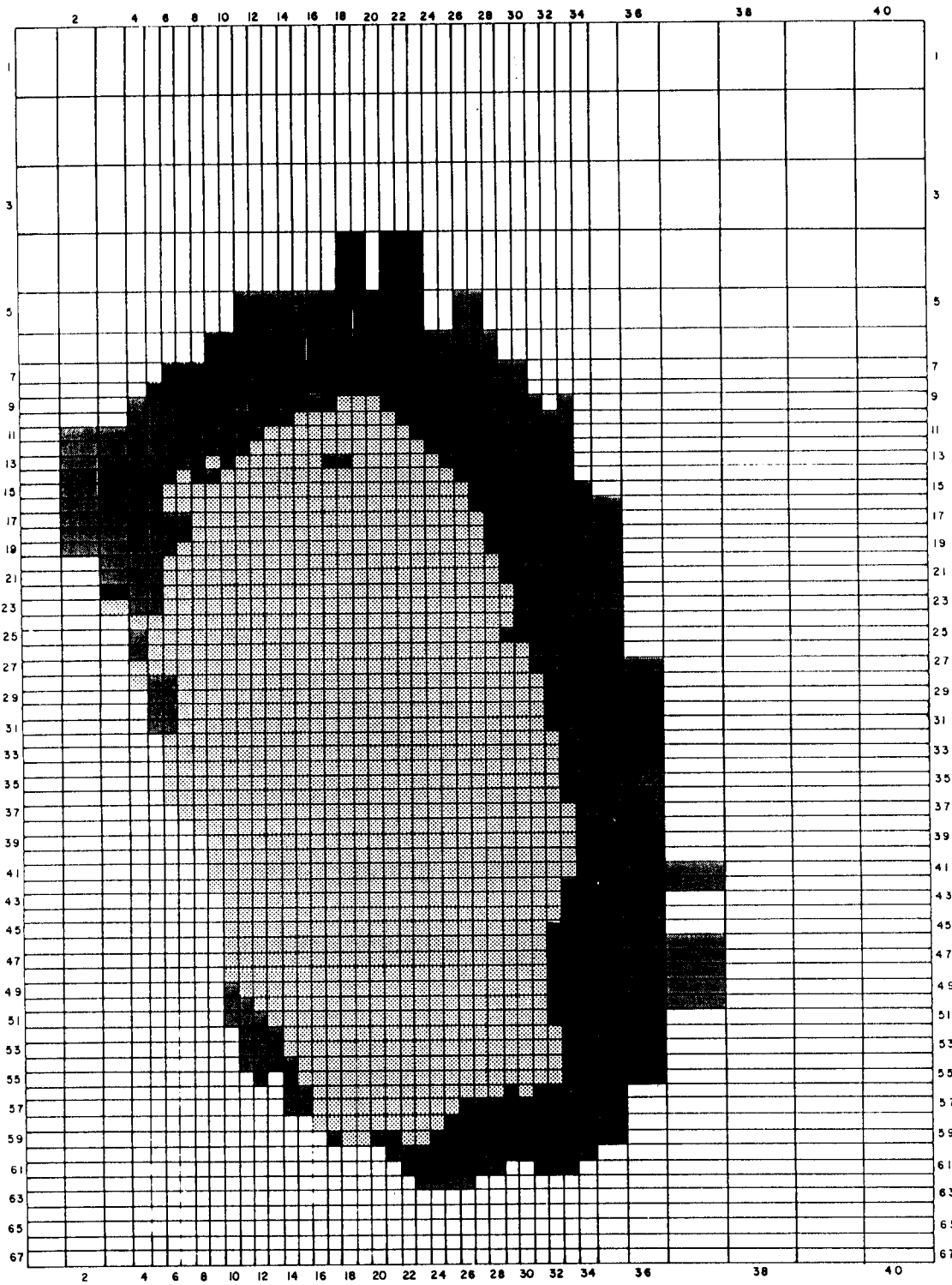

Figure 49. Storage Coefficient of the Denver aquifer

STORAGE COEFFICIENTS OF THE ARAPAHOE AQUIFER



EXPLANATION

- $1 \times 10^{-4} \leq s < 1 \times 10^{-3}$
- $1 \times 10^{-2} \leq s < 1 \times 10^{-1}$
- $1 \times 10^{-1} \leq s$

Figure 50. Storage Coefficient of the Arapahoe aquifer

STORAGE COEFFICIENTS OF THE LARAMIE-FOX HILLS AQUIFER

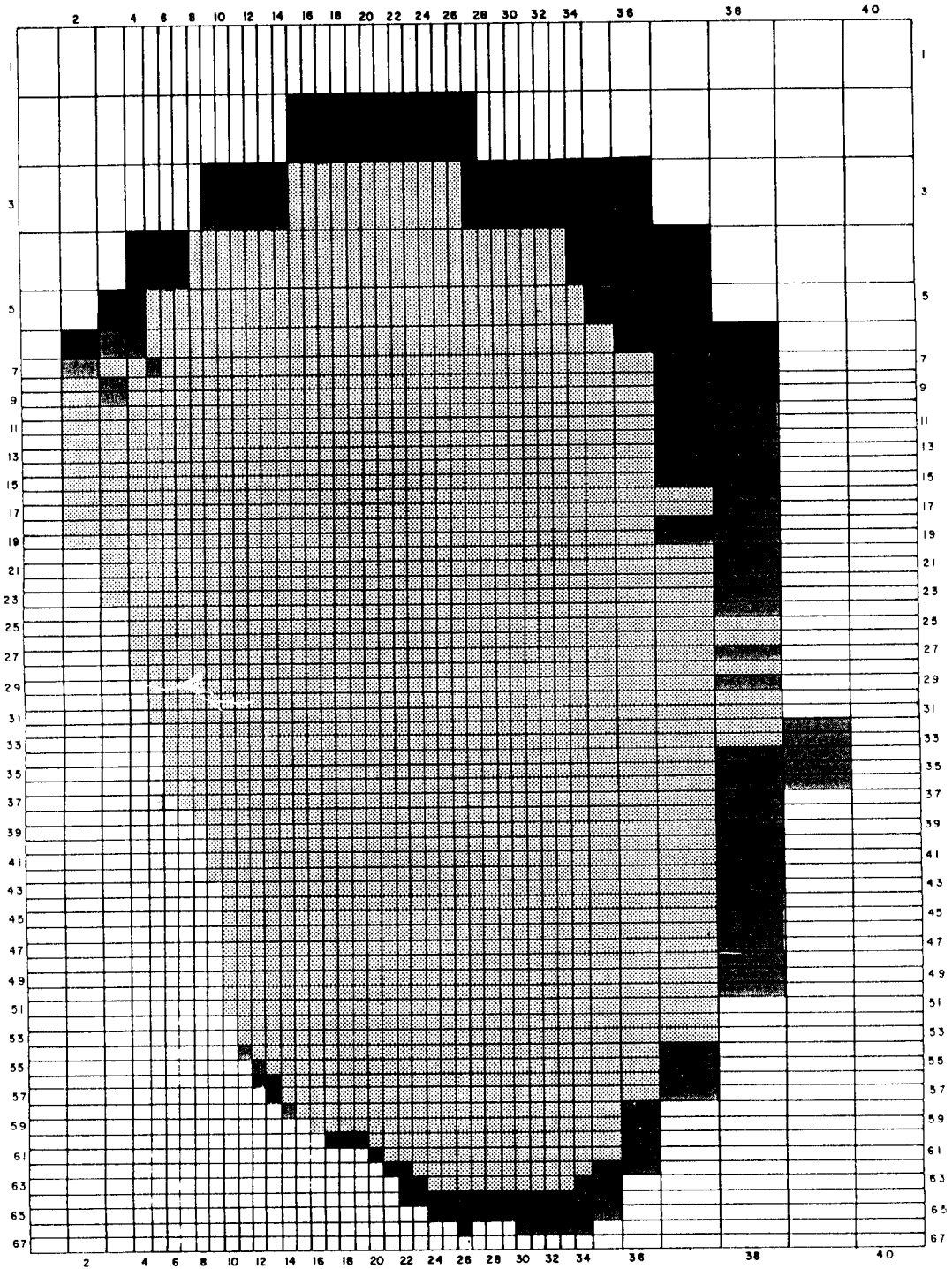

EXPLANATION

- $1 \times 10^{-4} \leq S < 1 \times 10^{-3}$
- $1 \times 10^{-2} \leq S < 1 \times 10^{-1}$
- $1 \times 10^{-1} \leq S$

Figure 51. Storage Coefficient of the Laramie-Fox Hills aquifer

represents the equivalent hydraulic resistance between layers. VCONT has units of T^{-1} . A more detailed description of VCONT is given in McDonald and Harbaugh (1988). Robson (1987) and Banta (1989) varied VCONT as part of model calibration. Distribution of VCONT between the Dawson and Denver aquifers, Denver and Arapahoe aquifers, and Arapahoe and Laramie-Fox Hills aquifers is illustrated in Figures 52, 53, and 54.

BOUNDARY CONDITIONS

Recharge simulates water that percolates down into the groundwater system. In this model, recharge is the net infiltration which results from the combined processes of precipitation, runoff, and evapotranspiration. Figure 55 shows the distribution of recharge in the model. Precipitation ranges from 11 to 18 inches per year in the basin, or 2.9×10^{-8} to 4.76×10^{-8} feet per second. Recharge ranges from 1.0×10^{-11} to 5.4×10^{-9} feet per second in the bedrock and alluvial aquifers (0.02% to 25% of precipitation). Fixed head grid cells are specified to maintain a constant head during a simulation. The model computes the volume of water which must flow in, or out, of the model at that location to maintain that head. Constant head nodes may represent springs or rivers. Many of the fixed head locations used by Banta (1989) were not used in this model because the features were simulated with the river package. Locations of fixed head grid cells are presented in Figure 56.

Most of the rivers were modeled using the RIVINT module (Figure 57). These rivers include Squirrel Creek, Monument Creek, Big Sandy Creek, Plum Creek, Cherry Creek, Coal Creek, Box Elder Creek, Kiowa Creek, Commanche Creek, Bear Creek, Clear Creek, Ralston Creek, Big Dry Creek, and the South Platte River. Box Elder, Kiowa, and Commanche Creeks were modeled where they flow over the Dawson, but were not continued beyond that due to their intermittent character. Bijou Creek and Lost Creek were represented by constant head nodes except in the upper reaches of West Bijou Creek which were simulated with RIVINT features.

Although many of the stream beds are wide, during low flow, the streams in the basin only occupy a small area of the stream bed. Therefore, most of the streams were modeled with a bottom width of one to two feet, and a gently sloping side of 5 to 10 degrees. The length of the stream was determined using county maps on a scale of 1:50,000 so that the sinuosity of the stream was taken into account. Horizontal seepage distance was calculated as described in the section on input parameters for the RIVINT code. Head in the river was estimated from county maps and the map of head in alluvium included in the publication by Norris and others (1985), (Figure 38).

Limited information is available for streamflow in the basin. Figure 39 shows the location of gaging stations from which information was used in this study. These stations are located on Cherry Creek, Plum Creek, Kiowa Creek, Monument Creek, St Vrain Creek, Big Thompson River, Cache la Poudre River, and South Platte River (Table 1). Streamflow from outside the model area occurs where streams enter the modeled area. Streams receiving flow from outside the model area are West Monument Creek, Monument Creek, West Plum Creek, South Platte River, Bear Creek, Clear Creek, Ralston Creek, Big Dry Creek, Coal Creek and St. Vrain Creek. Values for these flows were estimated from flow rates at downstream gage stations. For example, the increased flow in the South Platte river between gaging stations was assumed to be due to flow from tributaries, diversions and return flows, and seepage gains and losses. The portion of flow from tributary reaches was estimated and input as an external inflow (Figure 57). Inflow from reservoirs located along modeled rivers in the basin were also included. In many cases these reservoirs are small and the average annual discharge is small.

VERTICAL CONDUCTANCES BETWEEN THE DAWSON AND DENVER AQUIFERS

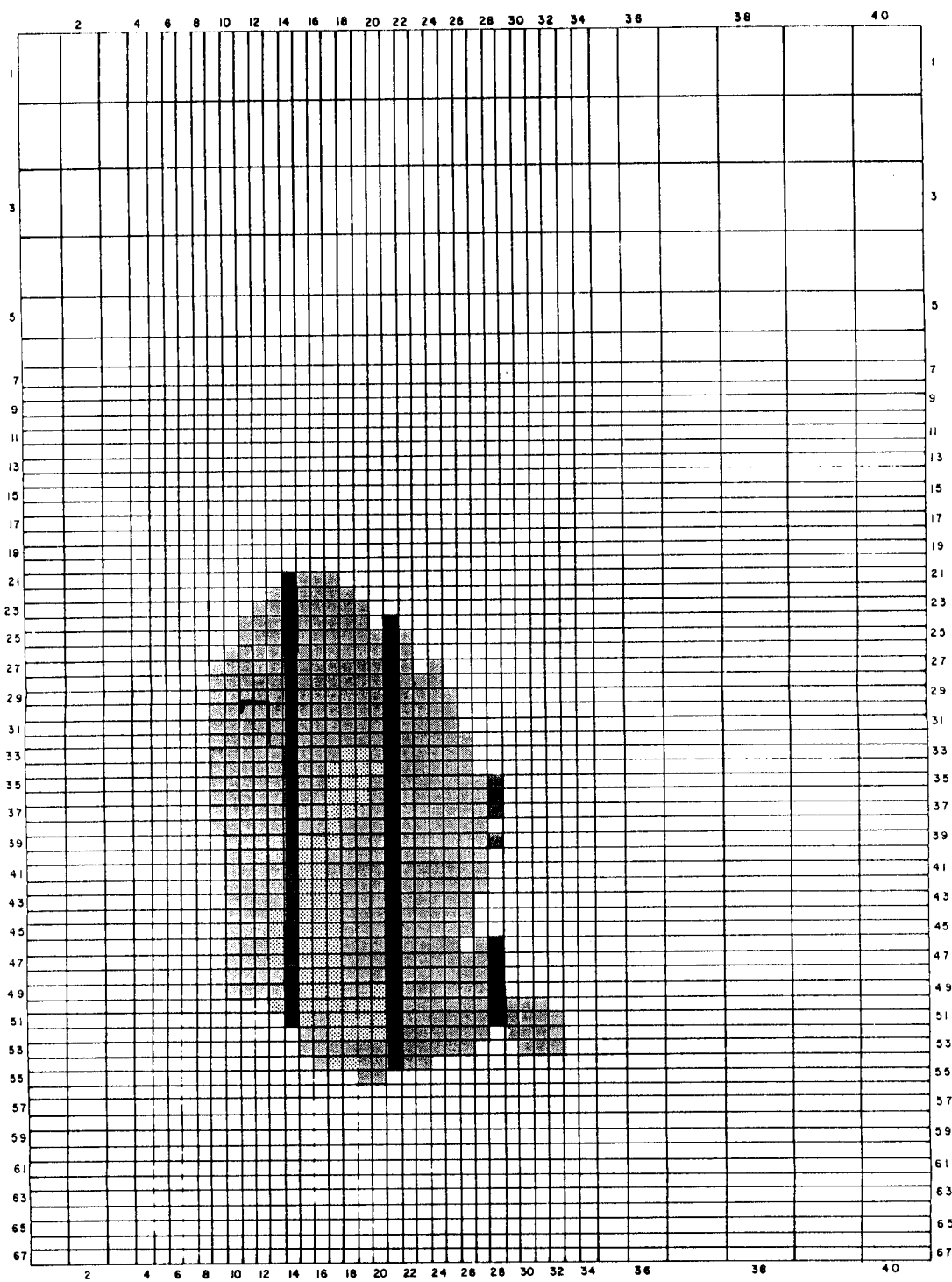

EXPLANATION

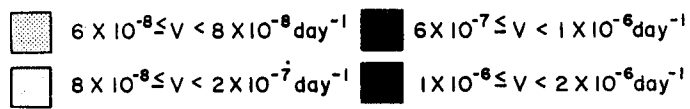
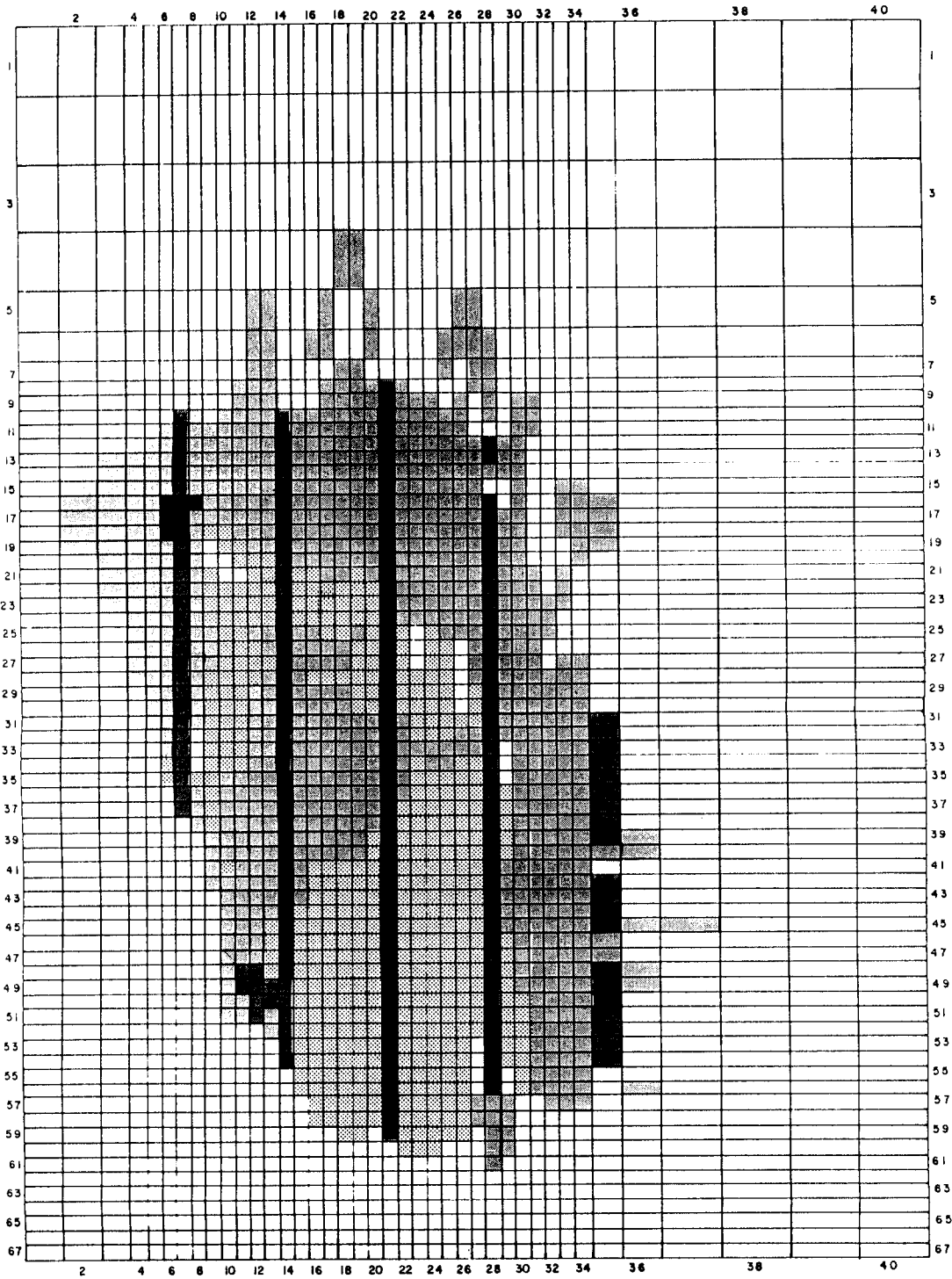

Figure 52. Vertical conductance between the Dawson and Denver aquifers

VERTICAL CONDUCTANCES BETWEEN THE DENVER AND ARAPAHOE AQUIFERS



EXPLANATION

- | | |
|---|--|
| <p> $5 \times 10^{-9} \leq V < 3 \times 10^{-8} \text{ day}^{-1}$</p> <p> $3 \times 10^{-8} \leq V < 1 \times 10^{-7} \text{ day}^{-1}$</p> <p> $1 \times 10^{-7} \leq V < 4 \times 10^{-7} \text{ day}^{-1}$</p> | <p> $4 \times 10^{-7} \leq V < 9 \times 10^{-7} \text{ day}^{-1}$</p> <p> $V = 4 \times 10^{-6} \text{ day}^{-1}$</p> |
|---|--|

Figure 53. Vertical conductance between the Denver and Arapahoe aquifers

VERTICAL CONDUCTANCES BETWEEN THE ARAPAHOE AND LARAMIE-FOX HILLS AQUIFERS

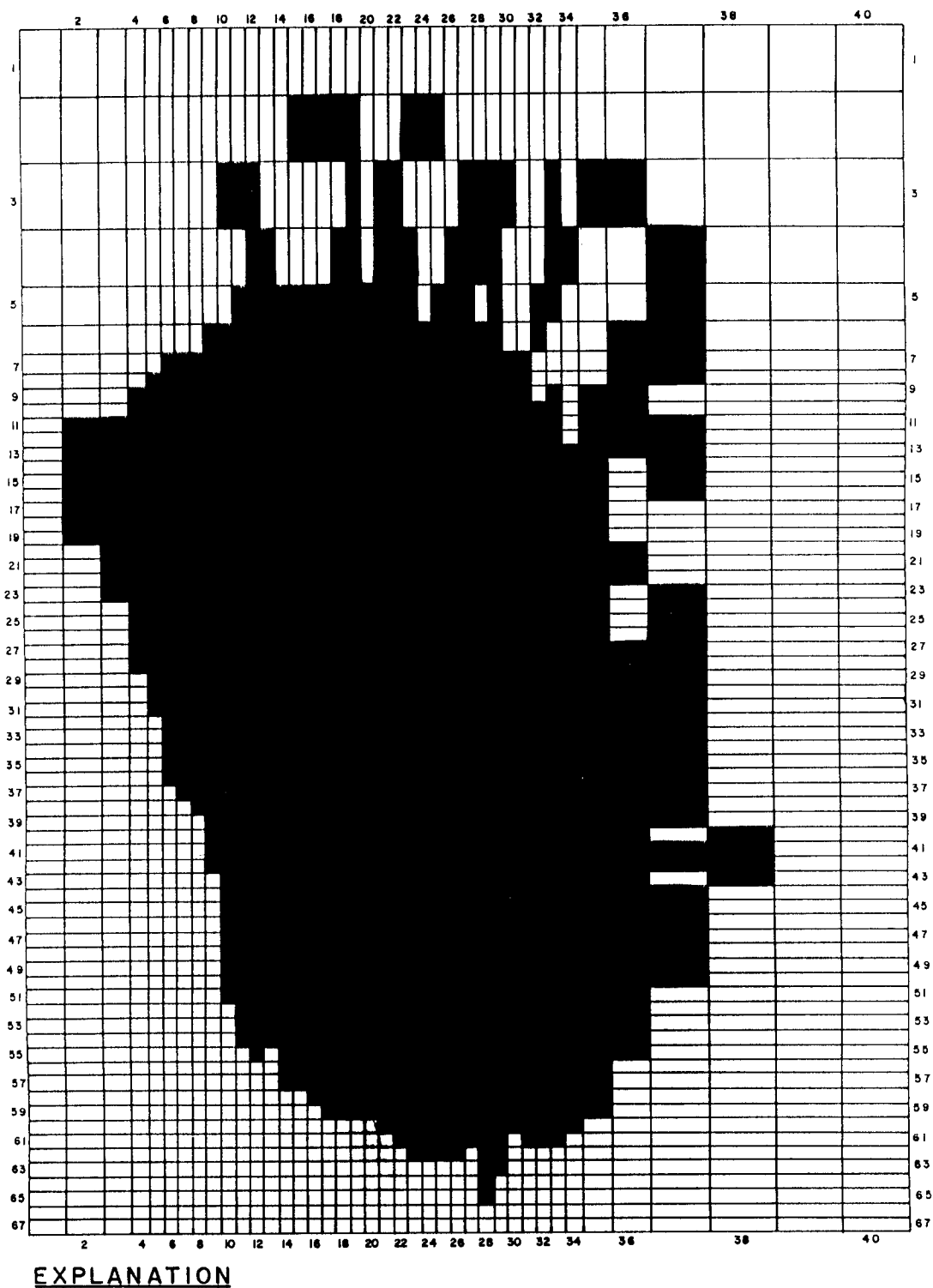

Figure 54. Vertical conductance between the Arapahoe and Laramie-Fox Hills aquifers

RECHARGE RATES TO THE DENVER BASIN

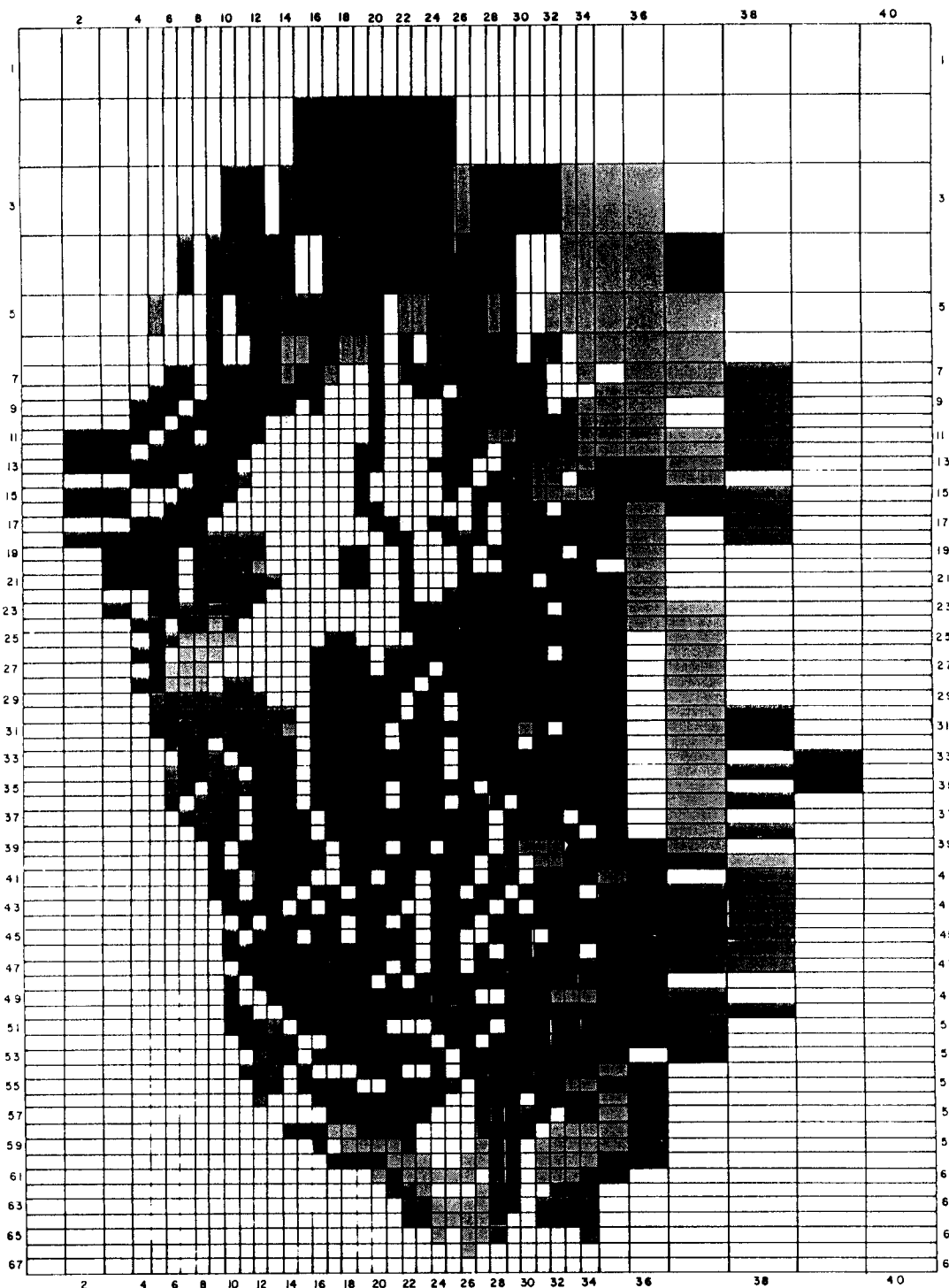

Figure 55. Recharge applied to the Basin

Table 1. Measured and simulated streamflows

station #	gaging station	location on grid (lay,row,col)	measured flow (cfs)	simulated flows		
				pristine	20yr	40yr
1	Plum Creek near Sedalia	2,31,7	32.0	17.1	17.0	16.8
2	Plum Creek near Louviers	2,28,5	28.7	17.2	17.1	17.0
3	Cherry Crk near Franktown	1,32,15	8.6	9.7	9.65	9.57
4	Cherry Creek near Melvin	1,25,13	11.8	10.7	10.6	10.4
5	South Platte at Henderson	2,10,10	367	285.57	285.56	285.54
6	South Platte at Fort Lupton	(not modeled)	345			
7	St Vrain Crk near Platteville	(not modeled)	222.9			
8	Big Thompson near LaSalle	(not modeled)	92.4			
9	Cache la Poudre near Greeley	(not modeled)	122.2			
10	South Platte near Kersey	(not modeled)	850			
11	Kiowa Crk at Elbert	1,43,23	0.9	4.11	4.08	4.05
12	Kiowa Cr at Kiowa	1,33,25	3.8	22.2	22.0	21.9
13	West Monument Creek at U.S. Air Force Academy	4,53,13	2.9	10.99	10.96	10.91
14	West Monument Creek at Pikeview	3,54,12	0.8	4.036	4.035	4.034

SELECTED RIVER LOCATIONS

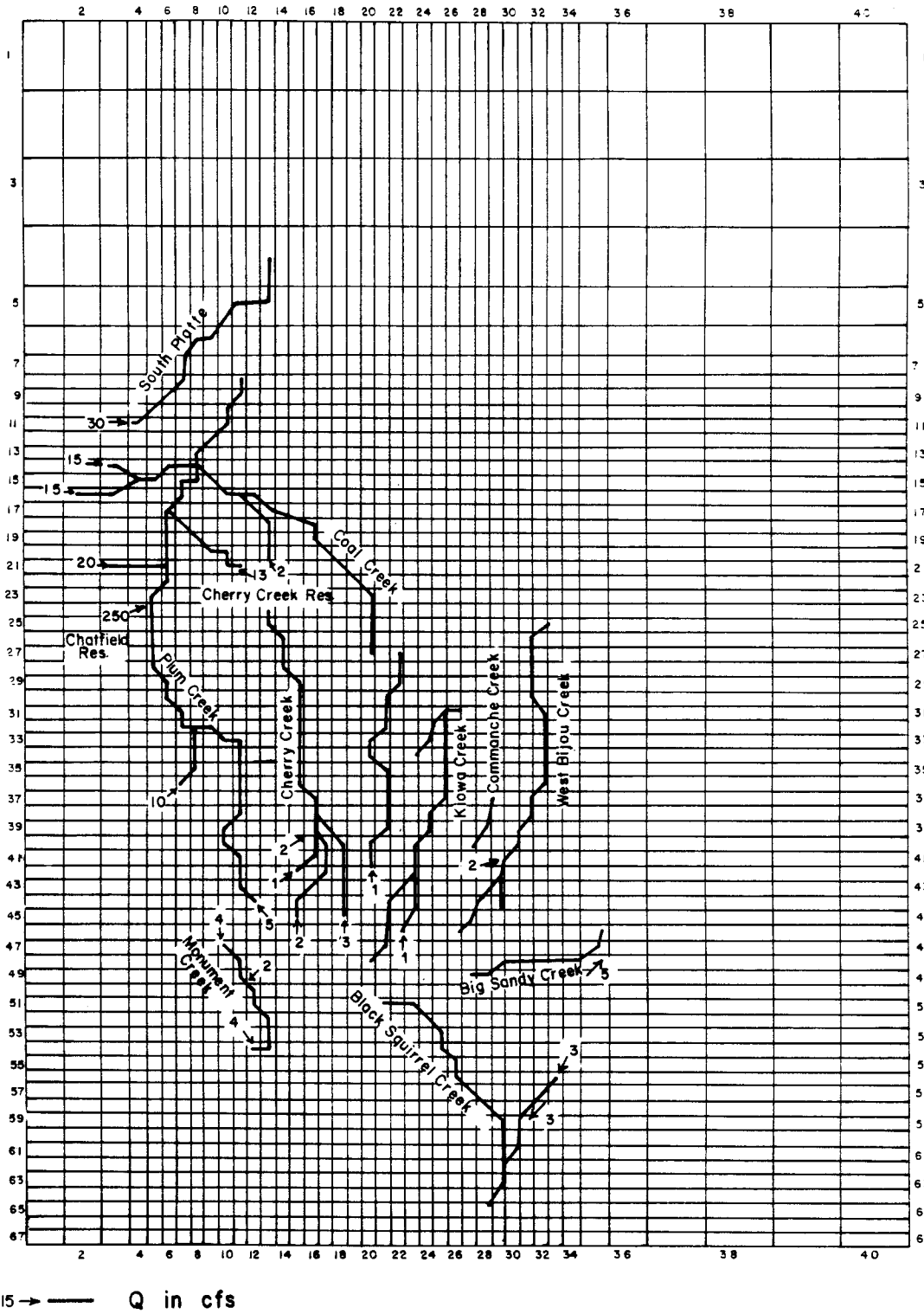

Figure 57. River reaches simulated in the model and external inflows applied to the model

INITIAL CONDITIONS

Before the impact of stresses on the geohydrologic system can be evaluated using the model, an equilibrium initial condition must be established. In the case of the Denver Basin, this initial condition is the average annual condition prevailing in the Basin before development of groundwater resources ("pristine" conditions). Data from "pristine" conditions are not available, therefore post pumping data must be extrapolated into the past for the purpose of calibration. Banta (1989) calibrated the model to these "pristine" conditions by adjusting recharge, vertical conductance between aquifers, and transmissivity using a mean square error calculation to assess the level of agreement between field and modeled heads. A complete explanation of this calibration is given in Banta (1989).

In its current form, the code cannot be executed in steady state mode when alluvium is explicitly simulated using the RIVINT package. Therefore, to obtain an initial steady state "pristine" configuration for the flow system, the model was run in a transient mode without stresses to the aquifers until heads in the explicitly modeled alluvium in Box Elder and Kiowa creeks, and river flows were constant with time. These "pristine" heads were input as initial heads in the river package. Simulated "pristine" heads in the Dawson, Denver, Arapahoe, Laramie-Fox Hills, and alluvial aquifers, and stream discharges under "pristine" conditions are presented in Figures 58, 59, 60, 61, and 62 respectively.

Initial heads and flows calculated from this simulation do not seem reasonable, however measured field data from this era are not available. Heads in the Basin are generally higher than would be expected even before pumping of groundwater in the Basin. Simulation of pumping in the Basin for forty years produces a head distribution that reflects the impact of pumping and may have yielded heads more like those presented in Figures 34 through 38. Therefore, to confirm the conclusion that the bedrock aquifer parameters should be further calibrated before proceeding with the assessment of surface/groundwater interaction and to demonstrate the RIVINT module under aquifer stress conditions, pumping for a period of forty years was simulated.

STRESSES TO THE SYSTEM

Further calibration of the model is necessary before proceeding with a study to assess the impact of pumping bedrock aquifers on flow in rivers and alluvial aquifers. However, pumping of the system was simulated to compare post pumping field heads with simulated heads and to qualitatively demonstrate RIVINT's simulation of the response of streams and flow in alluvium to stresses on the groundwater system.

Pumping rates used in this simulation are rates from Robson (1987) for the first 20 years (generally representative of a period from 1958 to 1978) and from Banta (1989) for one of his simulations from 1974 to 1978, which were applied for the next 20 years (generally representative of a period from 1978 to 1998). Pumping was not simulated in the alluvial aquifers. The distribution of pumping is illustrated in Figures 63 through 66. Total pumping in all four aquifers is 37.3 cfs for the first 20 year period. The pumping rate is 55% higher for the second 20 year period. Simulated heads in the Dawson, Denver, Arapahoe, and Laramie-Fox Hills aquifers after 40 years of pumping are presented in Figures 67 through 70 respectively. Heads in alluvial aquifers did not differ enough from the "pristine" simulation to warrant a separate presentation.

River discharges measured in the field, simulated for "pristine" conditions and for conditions after 20 and 40 years of pumping are presented in Table 1. Heads and flows in the simulation should be generally on the order of present day heads and flows in the field. Discrepancies between simulated and present day flows, and between simulated and measured heads in alluvium and groundwater aquifers are attributed to imperfections in the calibration of the bedrock aquifer system which makes it impossible to properly calibrate the surficial system. Calibration of the bedrock parameters is beyond the scope of this project but is being pursued by a different project currently underway. Readers interested in future updated calibration input are encouraged to contact the Colorado Water Resources Institute or with the authors directly.

Just as this work is being completed, Banta's 1989 report was received. Maps of simulated heads in Banta (1989) confirm the discrepancies between field and simulated heads observed in this study. Although a

SIMULATED "PRISTINE" POTENTIOMETRIC SURFACE OF THE DAWSON AQUIFER

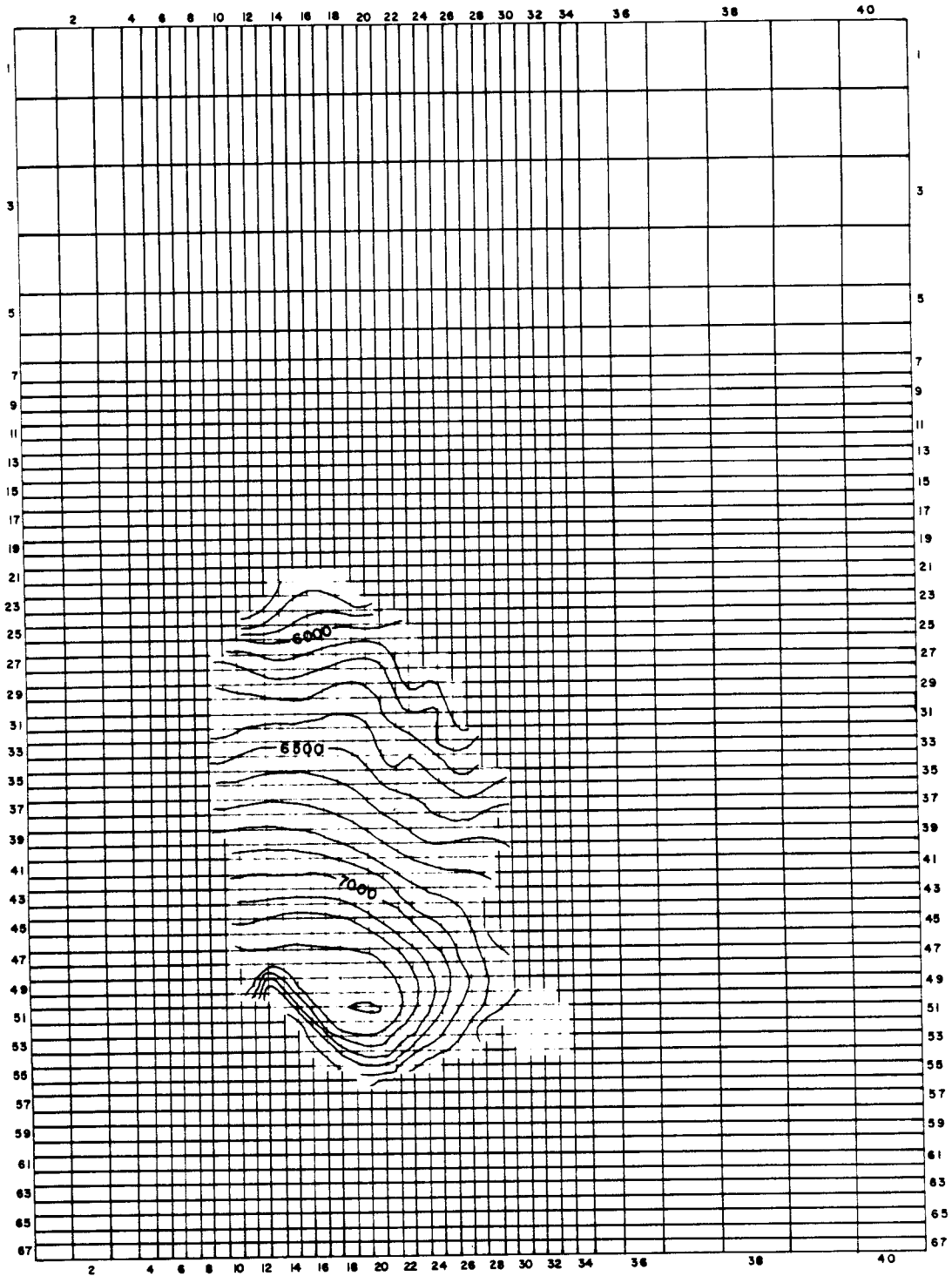

Figure 58. Simulated "pristine" potentiometric surface of the Dawson aquifer

SIMULATED "PRISTINE" POTENTIOMETRIC SURFACE OF THE DENVER AQUIFER

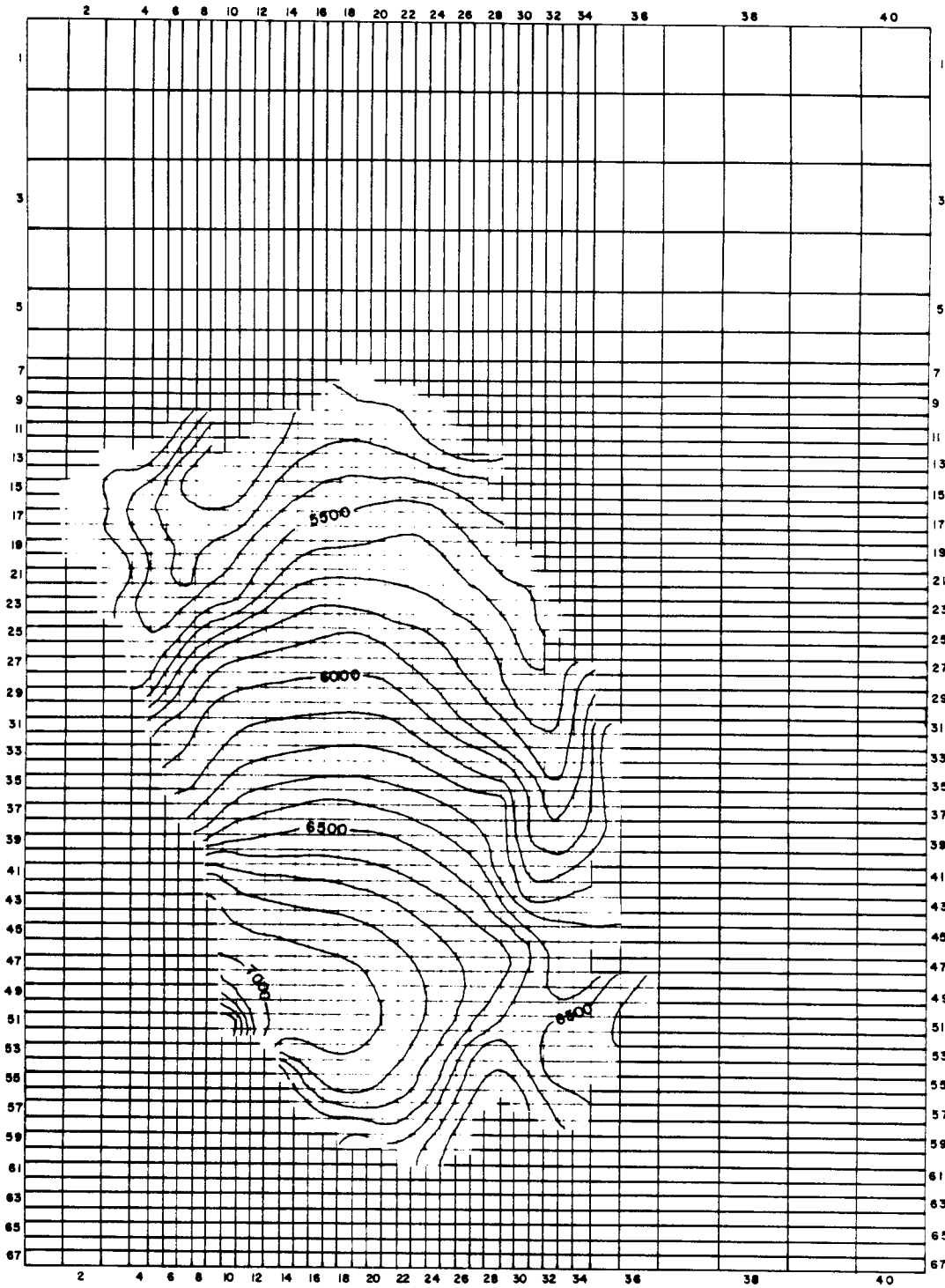

Figure 59. Simulated "pristine" potentiometric surface of the Denver aquifer

SIMULATED "PRISTINE" POTENTIOMETRIC SURFACE OF THE ARAPAHOE AQUIFER

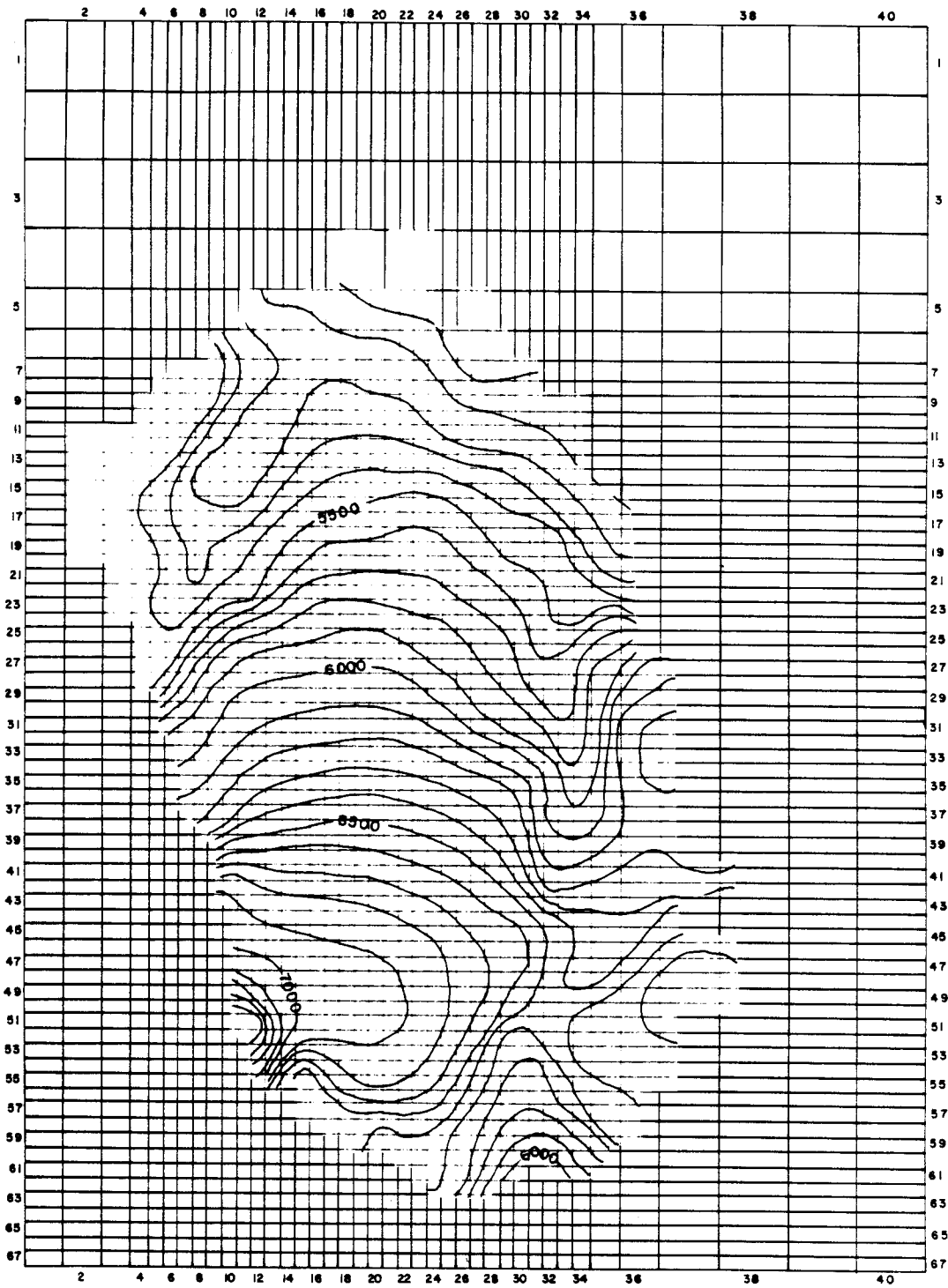

Figure 60. Simulated "pristine" potentiometric surface of the Arapahoe aquifer

SIMULATED "PRISTINE" POTENTIOMETRIC SURFACE OF THE LARAMIE-FOX HILLS AQUIFER

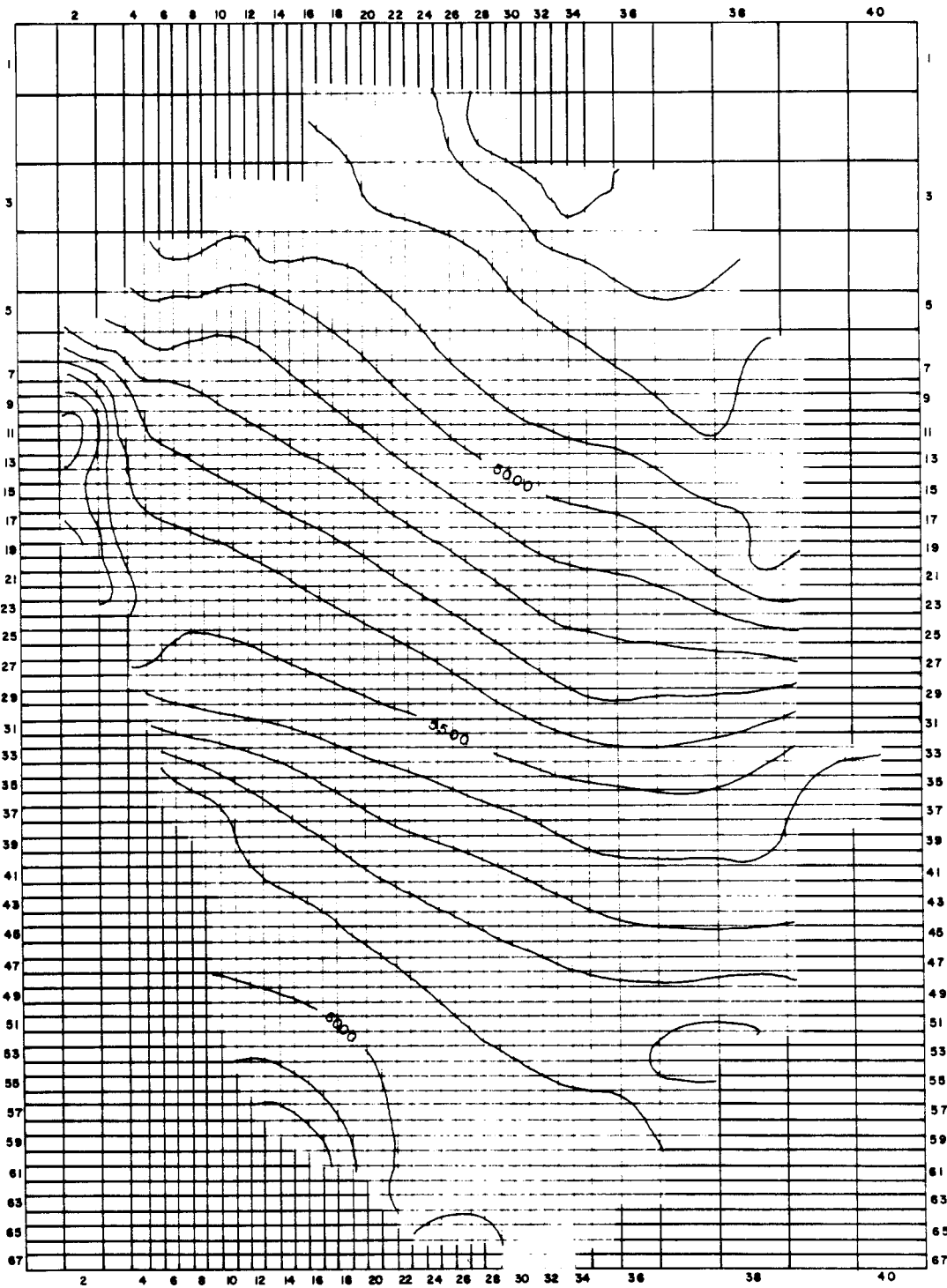

Figure 61. Simulated "pristine" potentiometric surface of the Laramie-Fox Hills aquifer

SIMULATED "PRISTINE" POTENTIOMETRIC SURFACE OF THE ALLUVIAL AQUIFERS

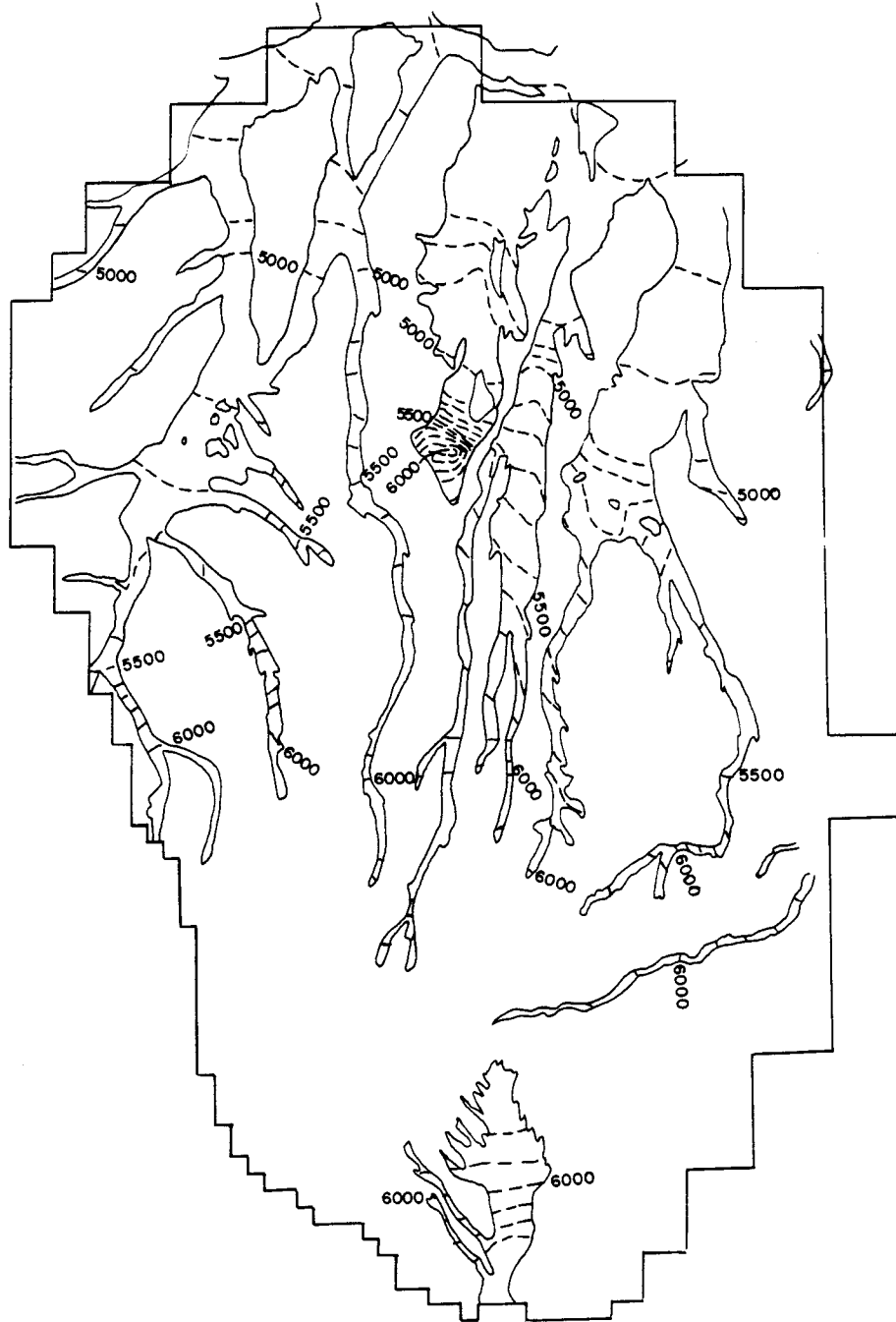
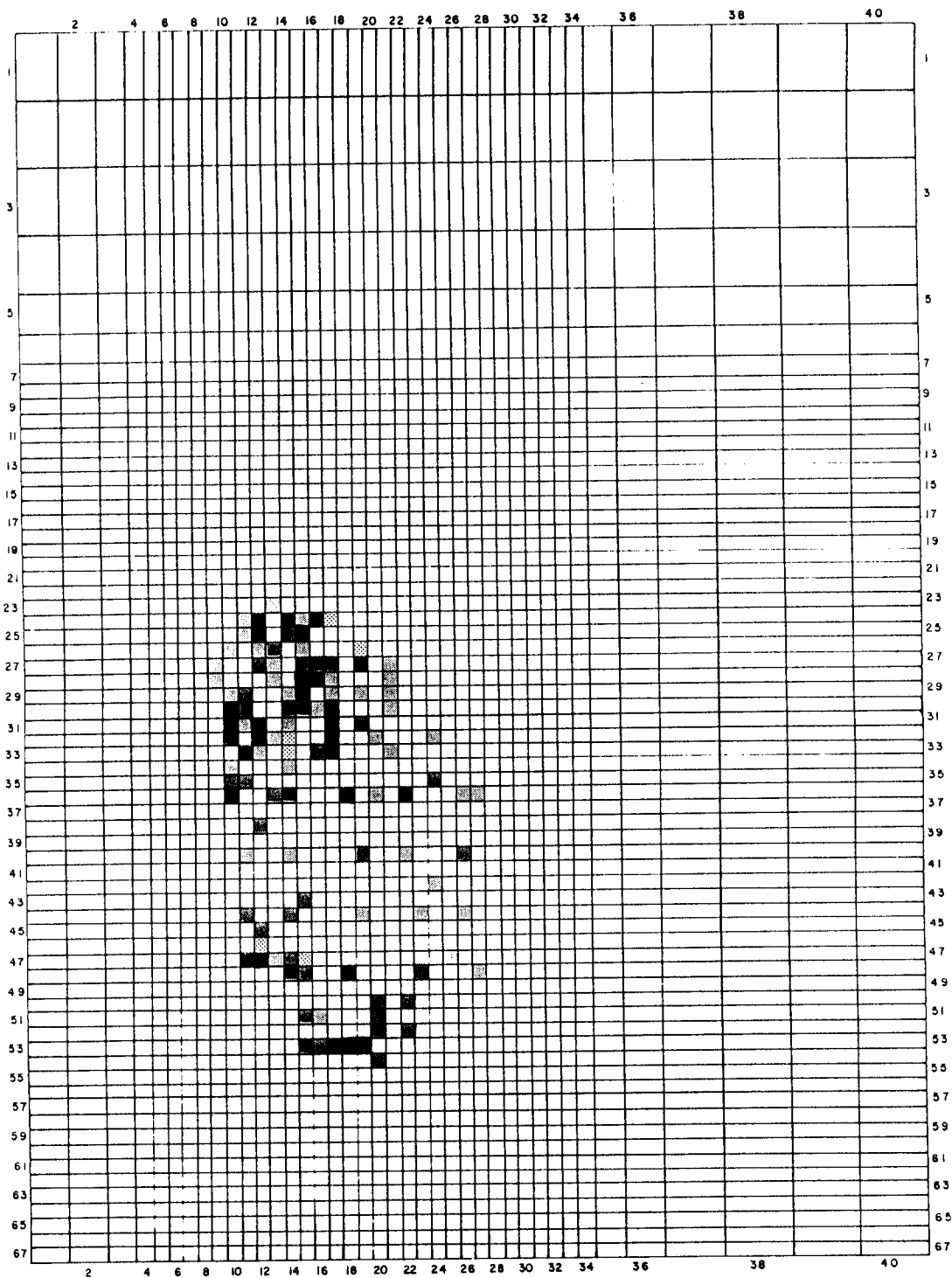

Figure 62. Simulated "pristine" potentiometric surface of the Alluvial aquifers

PUMPING RATES IN THE DAWSON AQUIFER



EXPLANATION

- | | |
|---|---|
| <p> $1 \times 10^{-4} \leq Q < 1 \times 10^{-2}$ ft³/sec, 1978-1998
 $(6 \times 10^{-5} \leq Q < 6 \times 10^{-3}$ ft³/sec, 1958-1978) </p> <p> $1 \times 10^{-2} \leq Q < 5 \times 10^{-2}$ ft³/sec, 1978-1998
 $(6 \times 10^{-3} \leq Q < 3 \times 10^{-2}$ ft³/sec, 1958-1978) </p> <p> $5 \times 10^{-2} \leq Q < 1 \times 10^{-1}$ ft³/sec, 1978-1998
 $(3 \times 10^{-2} \leq Q < 6 \times 10^{-2}$ ft³/sec, 1958-1978) </p> | <p> $1 \times 10^{-1} \leq Q < 2 \times 10^{-1}$ ft³/sec, 1978-1998
 $(6 \times 10^{-2} \leq Q < 1 \times 10^{-1}$ ft³/sec, 1958-1978) </p> <p> $2 \times 10^{-1} \leq Q$ ft³/sec, 1978-1998
 $(1 \times 10^{-1} \leq Q$ ft³/sec, 1958-1978) </p> |
|---|---|

Figure 63. Simulated Pumping in the Dawson aquifer

PUMPING RATES IN THE DENVER AQUIFER

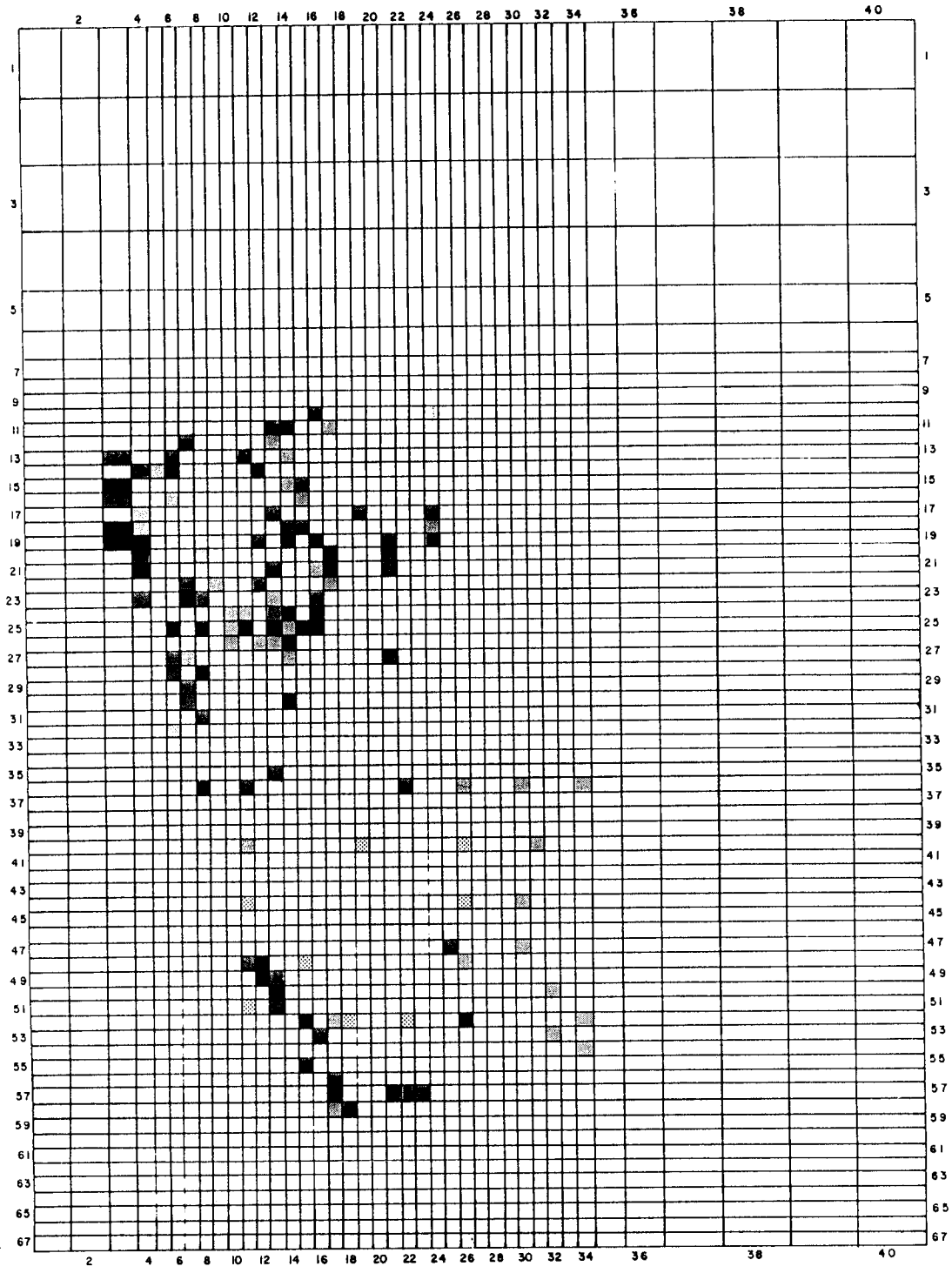

EXPLANATION

- | | |
|---|---|
| <p> $1 \times 10^{-4} \leq Q < 1 \times 10^{-2} \text{ ft}^3/\text{sec}$, 1978-1998
 $(6 \times 10^{-5} \leq Q < 6 \times 10^{-3} \text{ ft}^3/\text{sec}$, 1958-1978) </p> <p> $1 \times 10^{-2} \leq Q < 5 \times 10^{-2} \text{ ft}^3/\text{sec}$, 1978-1998
 $(6 \times 10^{-3} \leq Q < 3 \times 10^{-2} \text{ ft}^3/\text{sec}$, 1958-1978) </p> <p> $5 \times 10^{-2} \leq Q < 1 \times 10^{-1} \text{ ft}^3/\text{sec}$, 1978-1998
 $(3 \times 10^{-2} \leq Q < 6 \times 10^{-2} \text{ ft}^3/\text{sec}$, 1958-1978) </p> | <p> $1 \times 10^{-1} \leq Q < 2 \times 10^{-1} \text{ ft}^3/\text{sec}$, 1978-1998
 $(6 \times 10^{-2} \leq Q < 1 \times 10^{-1} \text{ ft}^3/\text{sec}$, 1958-1978) </p> <p> $2 \times 10^{-1} \leq Q \text{ ft}^3/\text{sec}$, 1978-1998
 $(1 \times 10^{-1} \leq Q \text{ ft}^3/\text{sec}$, 1958-1978) </p> |
|---|---|

Figure 64. Simulated Pumping in the Denver aquifer

PUMPING RATES IN THE ARAPAHOE AQUIFER

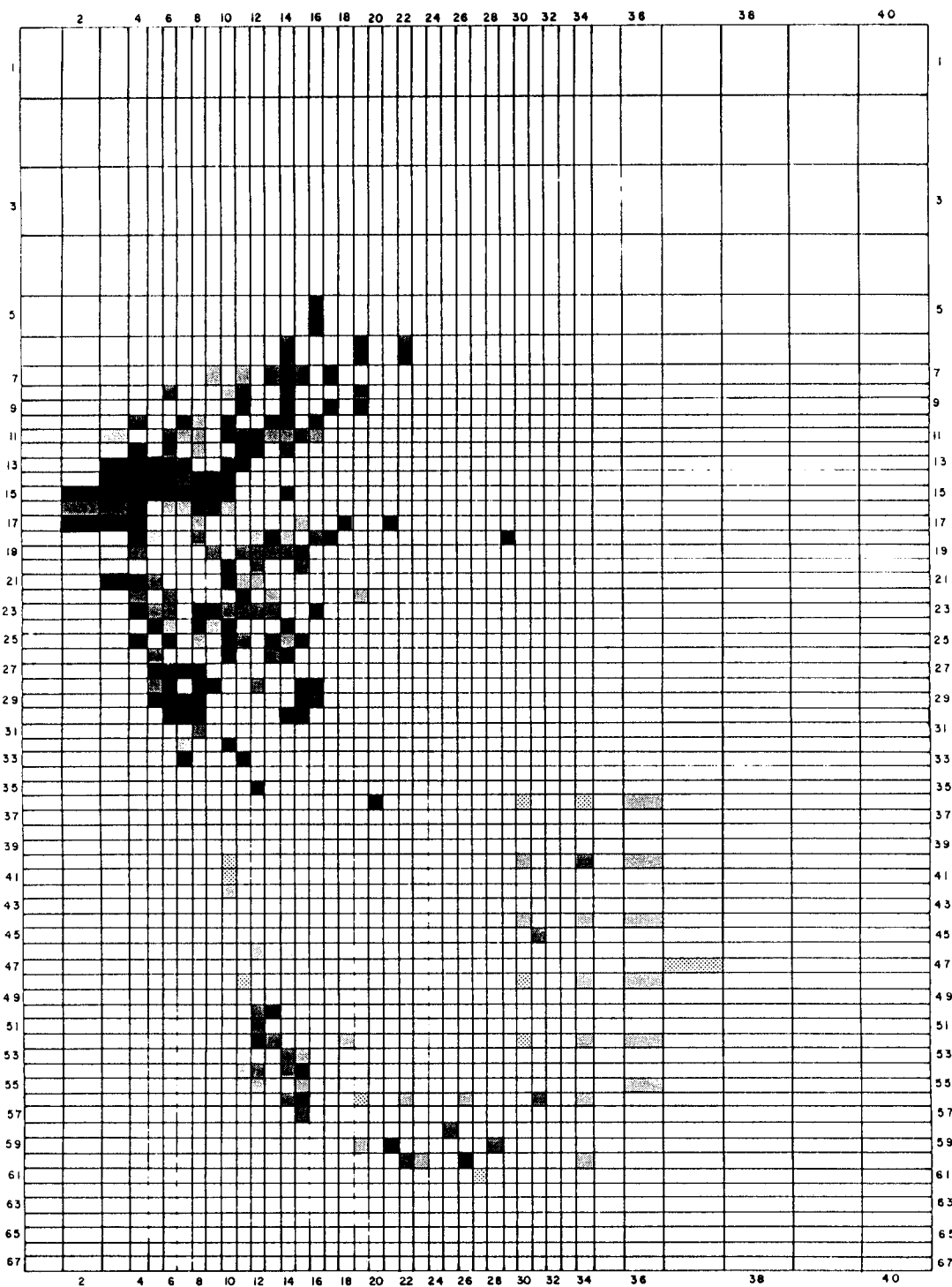

EXPLANATION





<p> $1 \times 10^{-4} \leq Q < 1 \times 10^{-2} \text{ ft}^3/\text{sec}$, 1978-1998 ($6 \times 10^{-5} \leq Q < 6 \times 10^{-3} \text{ ft}^3/\text{sec}$, 1958-1978)</p> <p> $1 \times 10^{-2} \leq Q < 5 \times 10^{-2} \text{ ft}^3/\text{sec}$, 1978-1998 ($6 \times 10^{-3} \leq Q < 3 \times 10^{-2} \text{ ft}^3/\text{sec}$, 1958-1978)</p> <p> $5 \times 10^{-2} \leq Q < 1 \times 10^{-1} \text{ ft}^3/\text{sec}$, 1978-1998 ($3 \times 10^{-2} \leq Q < 6 \times 10^{-2} \text{ ft}^3/\text{sec}$, 1958-1978)</p>	<p> $1 \times 10^{-1} \leq Q < 2 \times 10^{-1} \text{ ft}^3/\text{sec}$, 1978-1998 ($6 \times 10^{-2} \leq Q < 1 \times 10^{-1} \text{ ft}^3/\text{sec}$, 1958-1978)</p> <p> $2 \times 10^{-1} \leq Q \text{ ft}^3/\text{sec}$, 1978-1998 ($1 \times 10^{-1} \leq Q \text{ ft}^3/\text{sec}$, 1958-1978)</p>
--	---

Figure 65. Simulated Pumping in the Arapahoe aquifer

PUMPING RATES IN THE LARAMIE-FOX HILLS AQUIFER

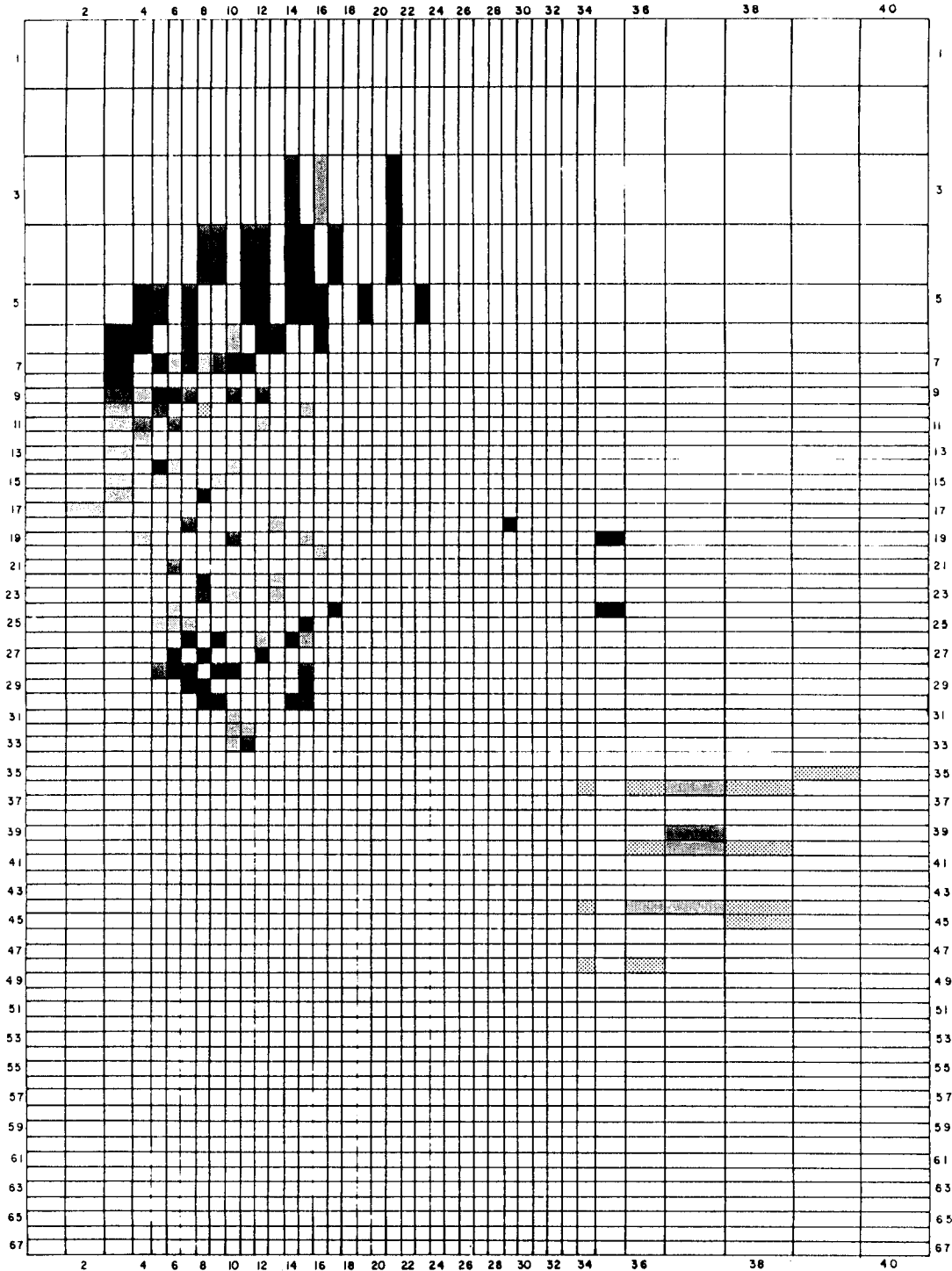

EXPLANATION

- | | |
|---|---|
| <p> $1 \times 10^{-4} \leq Q < 1 \times 10^{-2} \text{ ft}^3/\text{sec}$, 1978-1998
($6 \times 10^{-5} \leq Q < 6 \times 10^{-3} \text{ ft}^3/\text{sec}$, 1958-1978)</p> <p> $1 \times 10^{-2} \leq Q < 5 \times 10^{-2} \text{ ft}^3/\text{sec}$, 1978-1998
($6 \times 10^{-3} \leq Q < 3 \times 10^{-2} \text{ ft}^3/\text{sec}$, 1958-1978)</p> <p> $5 \times 10^{-2} \leq Q < 1 \times 10^{-1} \text{ ft}^3/\text{sec}$, 1978-1998
($3 \times 10^{-2} \leq Q < 6 \times 10^{-2} \text{ ft}^3/\text{sec}$, 1958-1978)</p> | <p> $1 \times 10^{-1} \leq Q < 2 \times 10^{-1} \text{ ft}^3/\text{sec}$, 1978-1998
($6 \times 10^{-2} \leq Q < 1 \times 10^{-1} \text{ ft}^3/\text{sec}$, 1958-1978)</p> <p> $2 \times 10^{-1} \leq Q \text{ ft}^3/\text{sec}$, 1978-1998
($1 \times 10^{-1} \leq Q \text{ ft}^3/\text{sec}$, 1958-1978)</p> |
|---|---|

Figure 66. Simulated Pumping in the Laramie-Fox Hills aquifer

SIMULATED POTENTIOMETRIC SURFACE OF THE DAWSON AQUIFER AFTER 40 YEARS OF PUMPING

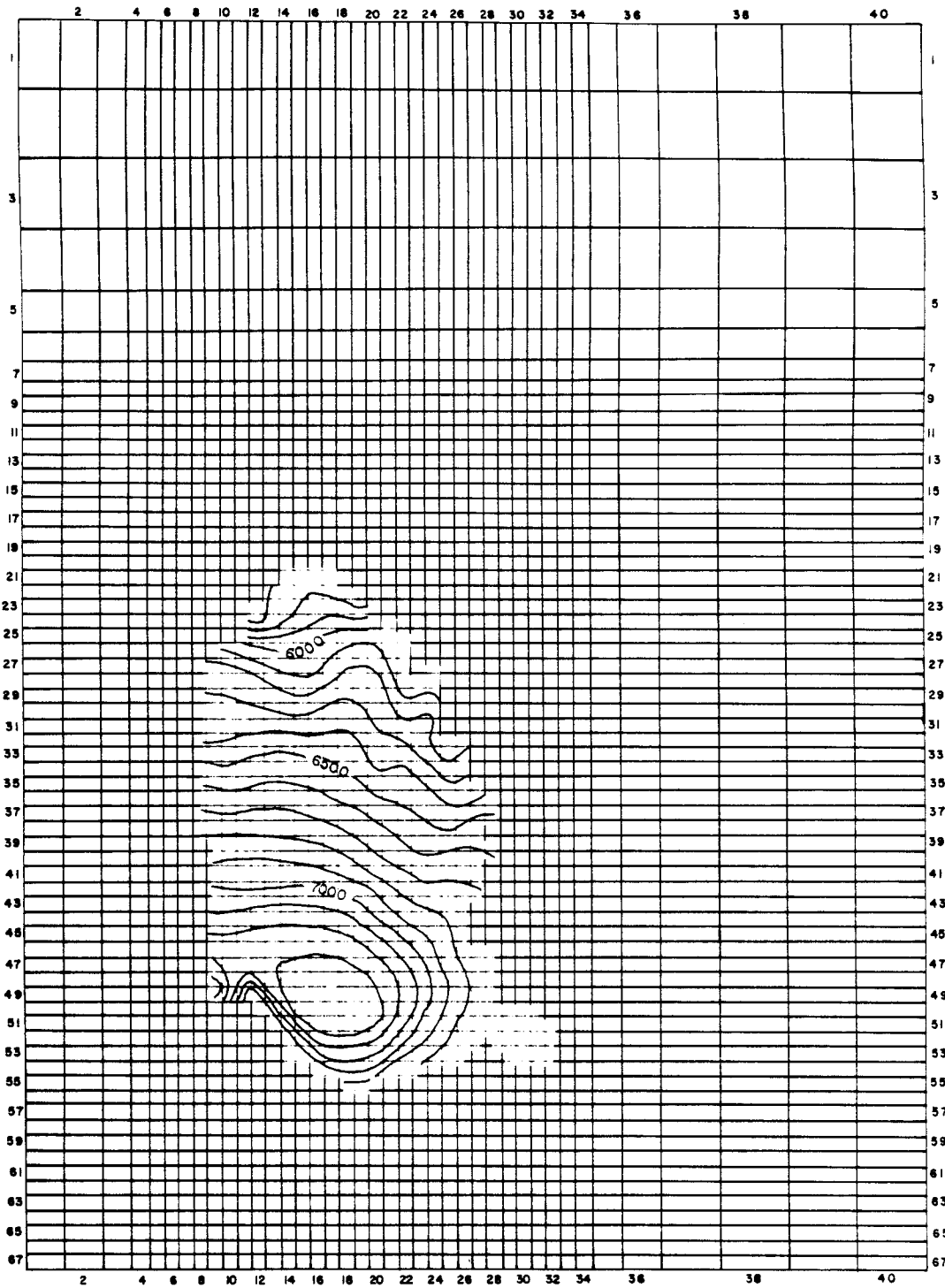

Figure 67. Simulated potentiometric surface of the Dawson aquifer after 40 years of pumping

SIMULATED POTENTIOMETRIC SURFACE OF THE DENVER AQUIFER AFTER 40 YEARS OF PUMPING

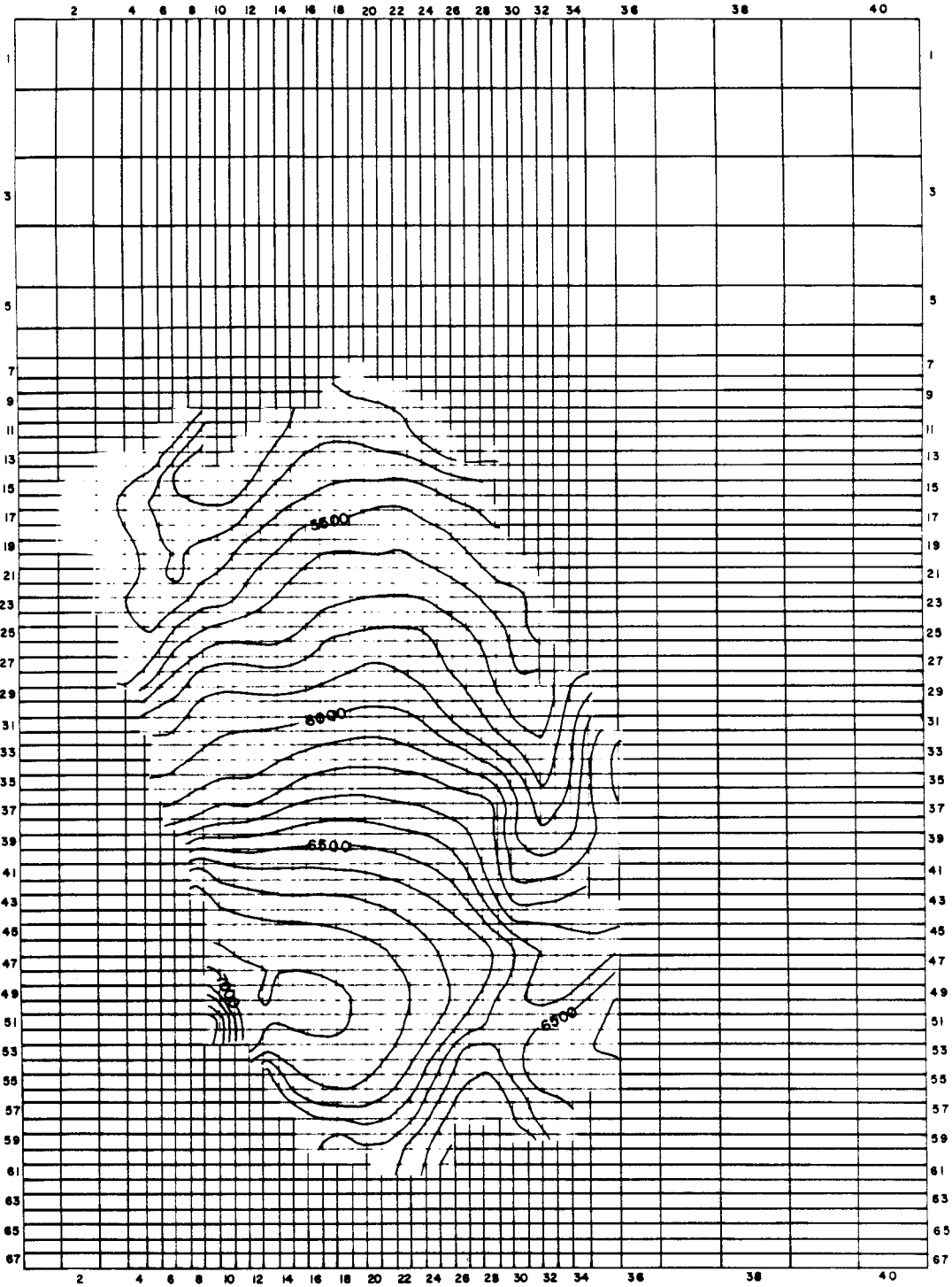

Figure 68. Simulated potentiometric surface of the Denver aquifer after 40 years of pumping

SIMULATED POTENTIOMETRIC SURFACE OF THE ARAPAHOE AQUIFER AFTER 40 YEARS OF PUMPING

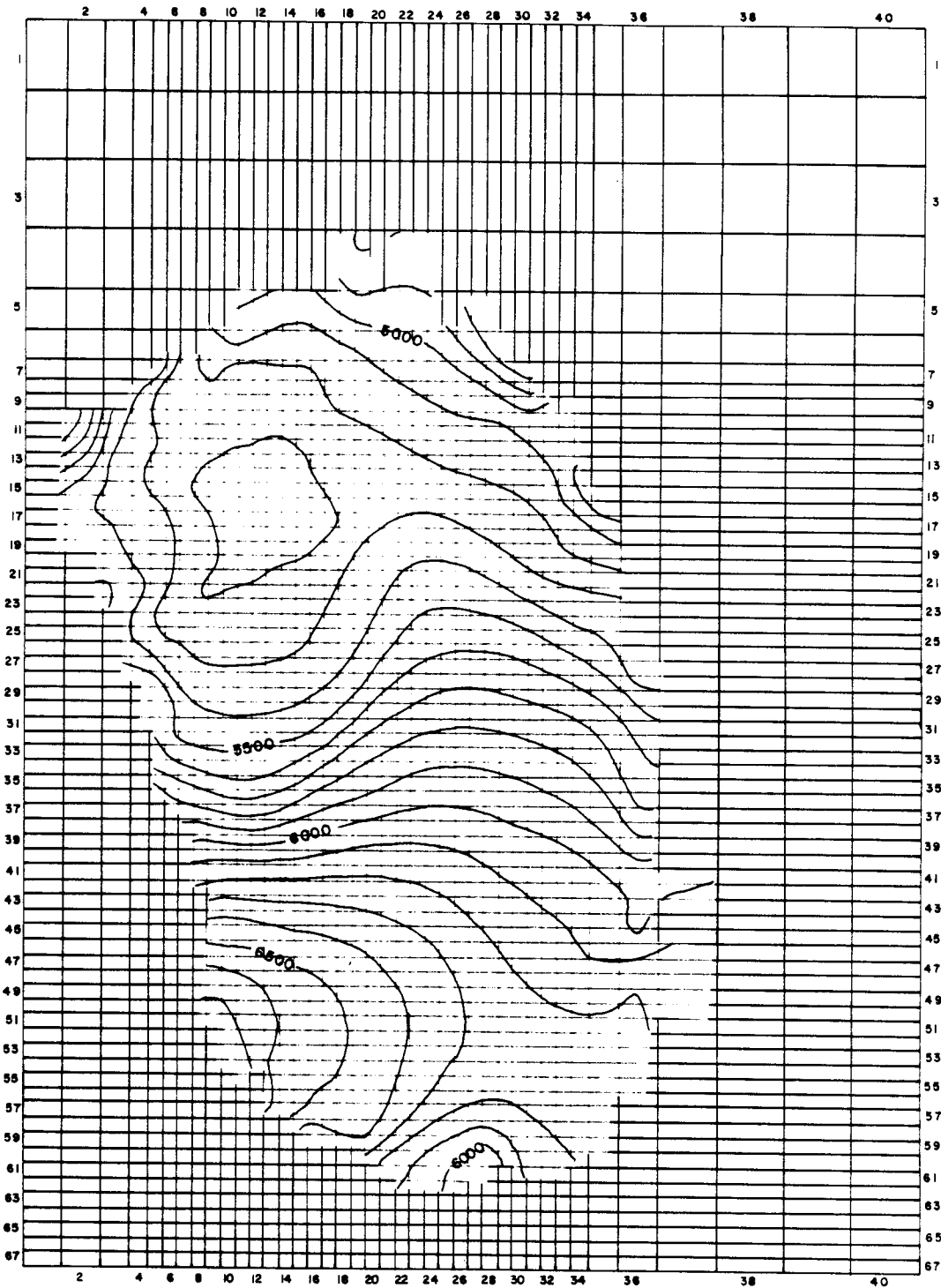

Figure 69. Simulated potentiometric surface of the Arapahoe aquifer after 40 years of pumping

SIMULATED POTENTIOMETRIC SURFACE OF THE LARAMIE-FOX HILLS AQUIFER AFTER 40 YEARS OF PUMPING

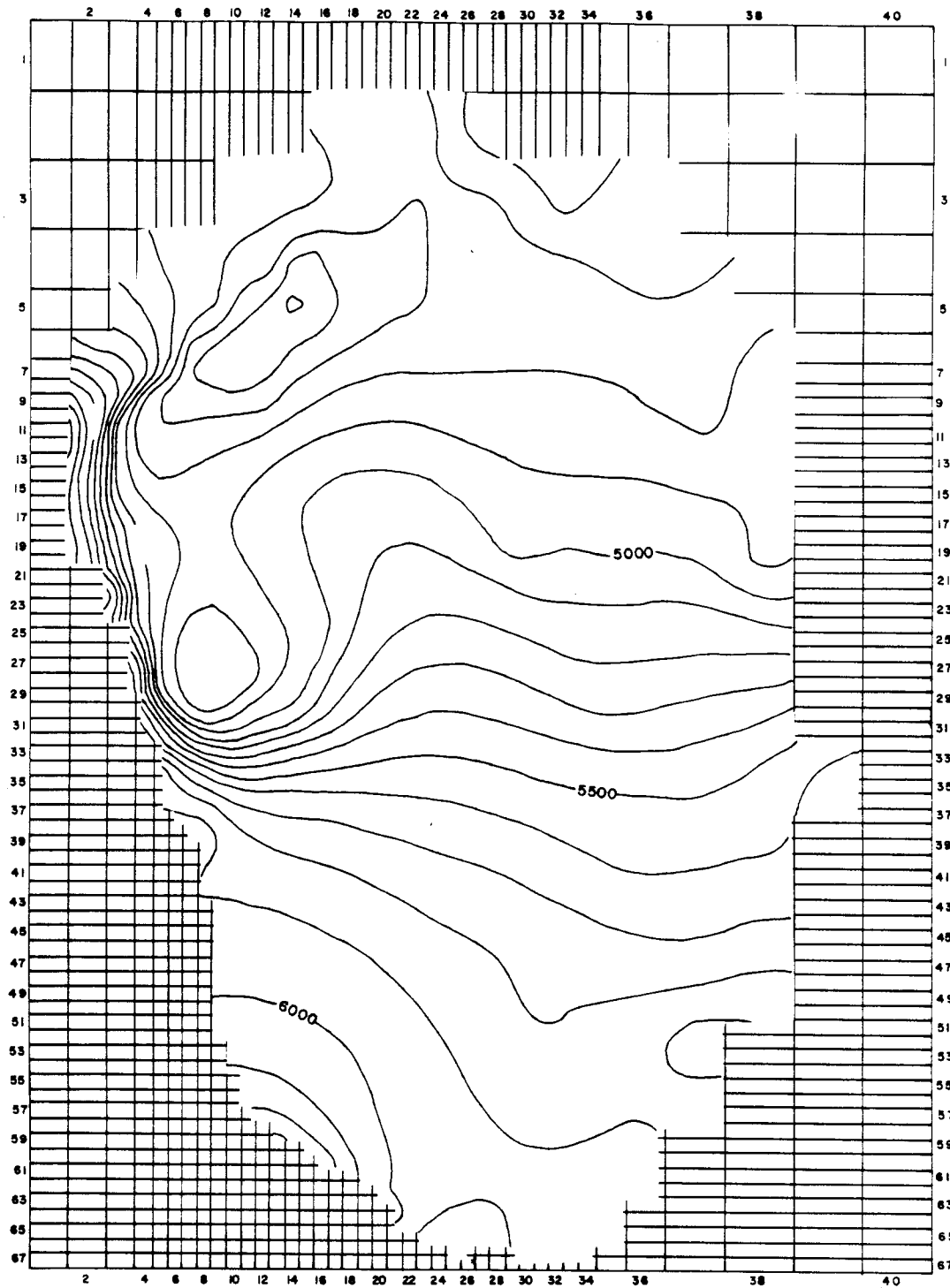

Figure 70. Simulated potentiometric surface of the Laramie-Fox Hills aquifer after 40 years of pumping

calibration with such discrepancies is quite useful for regional scale groundwater assessments, this tolerance is too large for simulation of groundwater/surface water interactions. In order to proceed with evaluation of surface/groundwater interactions in the Basin, the bedrock aquifer system must be calibrated to a closer tolerance. This should be undertaken in conjunction with simulation of surface/groundwater interactions and calibration of alluvial and river parameters. Such work is beyond the scope of this project. Further calibration should be accompanied by additional field data describing alluvium and river parameters.

FUTURE STUDIES

The groundwater model developed by Banta (1989) and used in this study was designed to evaluate geohydrologic conditions in El Paso county and to assess the potential responses of water levels in the bedrock aquifers to different rates and distributions of pumping in these aquifers (Banta, 1989). It was not necessary to have a model that was closely calibrated to the elevation of streams in the basin. In order to assess the impact on streams due to pumping in the basin, it will be necessary to calibrate the model heads to observed heads, particularly in areas near streams.

More information is needed on streamflow in the basin. In particular, hydrograph studies should be done to separate the baseflow from streamflow in the basin. Records of releases from reservoirs are needed to better determine streamflow resulting from releases. Gain/loss studies along river reaches should be utilized in calibrating the river model. Use of data from gain/loss studies will improve calibration of river parameters in the basin, such as silt layer hydraulic conductivity and thickness. Evaluation of water budgets for reservoirs in the Basin will also be valuable to calibration because model parameters can be adjusted to simulate calculated groundwater seepage and outflows to streams.

Estimates of river parameters in this study can be improved by conducting field studies. Geometry of river channels could be measured during low flows. Better estimates of roughness coefficients for streams in the Basin can be improved by using methods outlined by Jarrett (1985). Trenching of river beds would be useful to characterize the nature of fine grained layers of river sediments. Hydraulic conductivity measurements of core from river beds could be undertaken to improve estimates of river bed properties.

More information on properties of alluvium in the basin is also needed. In particular, additional data describing saturated thickness, hydraulic conductivity, specific yield, and rates of recharge to alluvial aquifers in the Basin are needed to improve model calibration.

SUMMARY

The RIVINT computer code is a useful tool for simulation of groundwater systems in arid and semi-arid regions where river flow can be significantly affected by stresses imposed on the groundwater system. Most available groundwater computer codes simulate rivers by assigning a river stage which remains constant throughout the computer simulation and/or allow for only one or two conditions of seepage between river and aquifer. RIVINT will simulate a variable river stage and will calculate seepage based on the conditions which exist between the river and aquifer during a simulation. Estimations of reduction or increase in river flow from stresses on the groundwater system will be improved by simulating more realistic conditions of seepage between the river and aquifer. If changes in river stage are not simulated, the water which can be removed from a groundwater basin may be overestimated. The end result may be over appropriation of water.

Preliminary simulation of the Denver Basin was based on the model developed by Banta (1989). Banta's grid, material properties, and boundary conditions were used as a basis for this simulation and alluvium and rivers were added to the grid. Only minor modifications of Banta's data set were required to obtain an operable model of the basin once the rivers were simulated in more detail. Numerous problems were encountered with calibration of the model and an improved model should be developed and calibrated

before application to water management problems in the Denver Basin. Details of these problems are discussed later in this report. In general the solution to these problems includes: 1) closer calibration of the bedrock flow system originally presented by Banta (1989) because river flows are substantially impacted by discrepancies between bedrock and field heads which in some areas are greater than 300 feet, 2) refinement of the original grid to allow more detailed simulation of river areas; 3) field measurement of parameters pertinent to surface water-groundwater interactions (e.g. channel geometry, river bed properties, and streamflows); and 4) thorough calibration of the model given the refined grid and improved data.

REFERENCES

- Banta, Edward R., 1989, Hydrologic effects of pumpage from the Denver Basin Bedrock aquifers of northern El Paso County, Colorado: U.S. Geological Survey Water-Resources Investigations Report 88-4033, 84 p.
- Buckles, David R., and Watts, Kenneth R., 1988, Geohydrology, water quality, and preliminary simulations of ground-water flow of the alluvial aquifer in the upper Black Squirrel Creek basin, El Paso County, Colorado: U.S. Geological Survey Water-Resources Investigations Report 88-4017, 49 p.
- Kraeger-Rovey, C., 1975, Numerical model of flow in a stream-aquifer system: Hydrology paper no. 74, Colorado State University, 73p.
- Hurr, R. T., and Schneider, P. A., Jr., 1972, Hydrogeologic characteristics of the valley-fill aquifer in the Greeley reach of the South Platte River valley, Colorado: U.S. Geological Survey Open-File Report 73-124, 2p., 7 maps.
- Hurr, R. T., Schneider, P. A., Jr., and others, 1972, Hydrogeologic characteristics of the valley-fill aquifer in the Weldona reach of the South Platte River valley, Colorado: U.S. Geological Survey Open-File Report 73-127, 2p., 7 maps.
- Jarrett, Robert D., 1985, Determination of roughness coefficients for streams in Colorado: U.S. Geological Survey Water-Resources Investigations Report 85-4004, 54 p.
- Konikow, L. F., 1975, Hydrogeologic maps of the alluvial aquifer in and adjacent to the Rocky Mountain Arsenal, Colorado: U.S. Geological Survey Open-File Report 74-342, scale 1:48,000.
- Major, T. J., Robson, S. G., Romero, J. C., and Zawistowski, Standly, 1983, Hydrologic Data from parts of the Denver Basin, Colorado: U.S. Geological Survey Open-File Report 83-274, 425 p.
- McConaghy, J.A., and others, 1964, Hydrogeologic data of the Denver basin, Colorado: Colorado Water Conservation Board Basic-Data Report 15, 224 p.
- McDonald, Michael G., and Harbaugh, Arlen W., 1988, A modular three-dimensional finite-difference ground-water flow model: U.S. Geological Survey Techniques of Water-Resources Investigations, Book 6, Modeling Techniques, Chapter A1.
- Norris, J. M., Robson, S. G., and Parker, R. S., 1983, Summary of hydrologic information for the Denver coal region, Colorado: U.S. Geological Survey Open-File Report 84-4337, 68 p.
- Pestch, Harold E., Jr., 1979, Streamflow summaries for Colorado streams through September 30, 1975, Volume 1: Missouri River, Arkansas River, and Rio Grande Basins: Open File Report 79-681, 515p.
- Robson, S. G., 1983, Hydraulic characteristics of the principal bedrock aquifers in the Denver basin, Colorado: U.S. Geological Survey Hydrologic Investigations Atlas HA-659, scale 1:500,000, 3 sheets.

- _____ 1987, Bedrock aquifers in the Denver basin, Colorado - a quantitative water-resources appraisal: U.S. Geological Survey Professional Paper 1257, 73p.
- Robson, S. G., and Romero, J. C., 1981a, Geologic structure, hydrology, and water quality of the Dawson aquifer in the Denver basin, Colorado: U.S. Geological Survey Hydrologic Investigations Atlas HA-643, scale 1:250,000, 3 sheets.
- _____ 1981b, Geologic structure, hydrology, and water quality of the Denver aquifer in the Denver basin, Colorado: U.S. Geological Survey Hydrologic Investigations Atlas HA-646, scale 1:500,000, 3 sheets.
- Robson, S. G., Romero, J. C., and Zawistowski, Stanley, 1981a, Geologic structure, hydrology, and water quality of the Arapahoe aquifer in the Denver basin, Colorado: U.S. Geological Survey Hydrologic Investigations Atlas HA-647, scale 1:500,000 and 1:250,000, 3 sheets.
- Robson, S. G., Wacinski, Andrew, Zawistowski, Stanley and Romero, J. C., 1981b, Geologic structure, hydrology, and water quality of the Laramie-Fox Hills aquifer in the Denver basin, Colorado: U.S. Geological Survey Hydrologic Investigations Atlas HA-650, scale 1:500,000, 3 sheets.

APPENDIX A

INPUT FORMATS

RIVER MODULE DATA WHEN ALLUVIUM IS NOT INCLUDED WITH RIVER REACHES

Note: This program is currently written to accept up to 3 upstream reaches.

REFER TO USERS MANUAL FOR DEFINITION OF TERMS

Enter one line for each simulation

10 20 30

MXRIVR IRIVCB IRVTYP
I10 I10 I10

Enter one line for each stress period

10

ITMP
I10
10 20 30

ISI DTOLD ITRD
I10 G10.4 I10

Enter the following information for each river reach

5 10 15 20 30 40 50

K I J LDN LUP LUP2 LUP3
I5 I5 I5 I5 I10 I10 I10
10 20 30 40 50 60 70 80

HRIV RBOT BWID SIDE AN RLNG SHY THS
G10.4 G10.4 G10.4 G10.4 G10.4 G10.4 G10.4 G10.4
10 20 30 40 50 60 70

SGHY THSG HNEG RSLP RSPDST BHY BBOT
G10.4 G10.4 G10.4 G10.4 G10.4 G10.4 G10.4
10 20 30 40 50

QRDVR QRRFQRPRCPQREVAP QRO
G10.4 G10.4 G10.4 G10.4 G10.4

For each stress period, enter a value for ITMP, ISI,DTOLD and ITRD
If ITMP is less than zero, reach information from the previous stress period
will be used.

If ITMP is greater than or equal to zero, it is the number of river reaches in
the current stress period, and information must be entered for each reach in
the stress period.

RIVER MODULE DATA WHEN RIVER AND ALLUVIUM ARE INCLUDED IN REACHES

Note: This program is currently written to accept up to 3 upstream reaches.
REFER TO USERS MANUAL FOR DEFINITION OF TERMS

Enter one line for each simulation

10	20	30	

MXRIVR	IRIVCB	IRVTYP	
I10	I10	I10	

Enter one line for each stress period

10	20	30	

ITMP			
I10			
10	20	30	

ISI	DTOLD	ITRD	
I10	G10.4	I10	

Enter the following information for each river reach

5	10	15	20	30	40	50			80

K	I	J	LDN	LUP	LUP2	LUP3			NOAL
I5	I5	I5	I5	I10	I10	I10			I10
10	20	30	40	50	60	70	80		

HRIV	RBOT	BWID	SIDE	AN	RLNG	SHY	THS		
G10.4	G10.4	G10.4	G10.4	G10.4	G10.4	G10.4	G10.4		
10	20	30	40	50	60	70			

SGHY	THSG	HNEG	RSLP	RSPDST	BHY	BBOT			
G10.4	G10.4	G10.4	G10.4	G10.4	G10.4	G10.4			
10	20	30	40	50					

QRDVR	QRRF	QRPRC	QREVAP	QRO					
G10.4	G10.4	G10.4	G10.4	G10.4					
10	20	30	40	50	60	70	80		

HAL	ABOT	WIDA	ALNG	AHY	SYA	ASPDST	ASLP		
G10.4	G10.4	G10.4	10.4	G10.4	G10.4	G10.4	G10.4		
10	20	30	40	50	60				

RCHALEV	TRAL	SURFAL	EXELAL	QAPMP	QAO				
G10.4	G10.4	G10.4	G10.4	G10.4	G10.4				

For each stress period, enter a value for ITMP, ISI,DTOLD and ITRD
If ITMP is less than zero, reach information from the previous stress period will be used.

directions are continued on next page

If ITMP is greater than or equal to zero, it is the number of river reaches in the current stress period, and information must be entered for each reach in the stress period.

APPENDIX B

RIVINT CODE

```

CX    SUBROUTINE RIV1AL(ISUM, LENX, LCRIVR, MXRIVR, NRIVER, IN, IOUT,
CX    1          IRIVCB)
      SUBROUTINE RINT1AL(ISUM, LENX, LCRIVR, MXRIVR, NRIVER,
      1          IN, IOUT, IRIVCB, IRVTYP, ITMUNI)
C
CX-----VERSION 0935 08DEC1983 RIV1AL
CRIVER
C-----VERSION - RIVINT - J. SCHENK & E. POETER JANUARY 1990
C-----THIS PROGRAM IS CURRENTLY DESIGNED TO HAVE UP TO FIVE
C-----UPSTREAM REACHES - HOWEVER, IT IS SUGGESTED THE USER ONLY HAVE
C-----UP TO THREE UPSTREAM REACHES AS OUTLINED IN THE USERS MANUAL
CRIVER
C *****
C    ALLOCATE ARRAY STORAGE FOR RIVERS
C *****
C
C    SPECIFICATIONS:
C    -----
C    -----
C
CIBMPC
      INTEGER*4 LENX
CIBMPC
C1-----IDENTIFY PACKAGE AND INITIALIZE NRIVER.
      WRITE(IOUT,1) IN
CX  1 FORMAT(1H0, 'RIV1 -- RIVER PACKAGE, VERSION 1, 12/08/83',
CX  2 ' INPUT READ FROM UNIT', I3)
CRIVER
      1 FORMAT(1H0, 'RIV1 -- RIVINT PACKAGE -- JANUARY 1990
      2 - J. SCHENK & E. POETER', ' INPUT READ FROM UNIT', I3)
CRIVER
      NRIVER=0
C
C2-----READ & PRINT MXRIVR & IRIVCB(UNIT OR FLAG FOR C-B-C FLOWS)
CX    READ(IN,2)MXRIVR,IRIVCB
CX  2 FORMAT(2I10)
CRIVER
C -----READ AND PRINT MXRIVR, IRIVCB, IRVTYP
      READ(IN,2)MXRIVR,IRIVCB,IRVTYP
      2 FORMAT(3I10)
CRIVER
      WRITE(IOUT,3)MXRIVR
      3 FORMAT(1H , 'MAXIMUM OF', I5, ' RIVER NODES')
      IF(IRIVCB.GT.0) WRITE(IOUT,9) IRIVCB
      9 FORMAT(1X, 'CELL-BY-CELL FLOWS WILL BE RECORDED ON UNIT', I3)
      IF(IRIVCB.LT.0) WRITE(IOUT,8)
      8 FORMAT(1X, 'CELL-BY-CELL FLOWS WILL BE PRINTED')
CRIVER
      IF (IRVTYP .EQ. 0) GO TO 12
      WRITE(IOUT,11)
      11 FORMAT (1X, 'RIVER REACHES MAY OR MAY NOT INCLUDE ALLUVIUM')
      GO TO 14
      12 WRITE(IOUT,13)
      13 FORMAT (1X, 'RIVER REACHES DO NOT INCLUDE ALLUVIUM')

```

```

C
C3-----SET LCRIVR EQUAL TO ADDRESS OF FIRST UNUSED SPACE IN X.
  14 LCRIVR=ISUM
C
C4-----CALCULATE AMOUNT OF SPACE USED BY RIVER LIST.
CX   ISP=6*MXRIVR
CRIVER
      ISP=49*MXRIVR
CRIVER
      ISUM=ISUM+ISP
C
C5-----PRINT AMOUNT OF SPACE USED BY RIVER PACKAGE.
      WRITE (IOUT,4)ISP
  4  FORMAT(1X,I6,' ELEMENTS IN X ARRAY ARE USED FOR RIVERS')
      ISUM1=ISUM-1
      WRITE(IOUT,5) ISUM1,LENX
  5  FORMAT(1X,I6,' ELEMENTS OF X ARRAY USED OUT OF',I7)
      IF(ISUM1.GT.LENX) WRITE(IOUT,6)
  6  FORMAT(1X,' ***X ARRAY MUST BE DIMENSIONED LARGER***')
C
C7-----RETURN
      RETURN
      END
C
CX   SUBROUTINE RIV1RP(RIVR,NRIVER,MXRIVR,IN,IOUT)
      SUBROUTINE RINT1RP(RIVR,NRIVER,MXRIVR,IN,IOUT,IRVTYP,
  1      ISI,DTOLD,ITRD,ITMUNI)
C
CX---VERSION 1319 25AUG1982 RIV1RP
CX   *****
CX   READ RIVER HEAD, CONDUCTANCE AND BOTTOM ELEVATION
CX   *****
CRIVER
C   -----RIVINT VERSION JAN1990 J. SCHENK & E. POETER
C   *****
C   READ RIVER AND ALLUVIUM PARAMETERS
C   *****
CRIVER
C   SPECIFICATIONS:
C   -----
CX   DIMENSION RIVR(6,MXRIVR)
CRIVER
      DIMENSION RIVR(49,MXRIVR)
CRIVER
C   -----
C
C   -----TIME UNITS MUST BE SPECIFIED TO USE THIS RIVER CODE
C   (VARIABLE ITMUNI IN BASIC PACKAGE) IF NOT SPECIFIED,
C   TERMINATE PROGRAM
      IF (ITMUNI.LE.0 .OR. ITMUNI.GT.5) WRITE(IOUT,3)
  3  FORMAT(//'***** YOU MUST ENTER A VALUE FOR ITMUNI (TIME UNITS) '
  1  'BETWEEN 1 AND 5 *****/' PROGRAM TERMINATED *****')
      IF (ITMUNI.GT.0 .AND. ITMUNI.LT.6) GO TO 4
C

```

```

C -----ABNORMAL STOP
      STOP
C
C1-----READ ITMP(NUMBER OF RIVER REACHES OR FLAG TO REUSE DATA)
      4 READ(IN,8)ITMP
      8 FORMAT(I10)
C
C2-----TEST ITMP.
      IF(ITMP.GE.0)GO TO 50
C
C2A-----IF ITMP <0 THEN REUSE DATA FROM LAST STRESS PERIOD.
      WRITE(IOUT,7)
      7 FORMAT(1H0,'REUSING RIVER REACHES FROM LAST STRESS PERIOD')
      GO TO 260
C
C3-----IF ITMP=> ZERO THEN IT IS THE NUMBER OF RIVER REACHES
      50 NRIVER=ITMP
C
C4-----IF NRIVER>MXRIVR THEN STOP.
      IF(NRIVER.LE.MXRIVR)GO TO 100
      WRITE(IOUT,99)NRIVER,MXRIVR
      99 FORMAT(1H0,'NRIVER(',I4,') IS GREATER THAN MXRIVR(',I4,')')
C
C4A-----ABNORMAL STOP.
      STOP
C
C5-----PRINT NUMBER OF RIVER REACHES IN THIS STRESS PERIOD.
      100 WRITE(IOUT,1)NRIVER
      1 FORMAT(1H0,//1X,I5,' RIVER REACHES')
C
C6-----IF THERE ARE NO RIVER REACHES THEN RETURN.
      IF(NRIVER.EQ.0) RETURN
CRIVER
C-----READ AND WRITE ISI,DTOLD,ITRD
      READ(IN,300) ISI,DTOLD,ITRD
      300 FORMAT(I10,G10.4,I10)
      IF (ISI .EQ. 1) GO TO 308
      WRITE(IOUT,307)
      307 FORMAT('0 ENGLISH UNITS ARE USED')
      GO TO 14
      308 WRITE(IOUT,309)
      309 FORMAT('0 METRIC UNITS ARE USED')
C
C -----DEFAULT TOLERANCE IF NOT ENTERED
      14 IF (DTOLD.EQ.0.0) DTOLD=0.1
      PERCNT=100.0*DTOLD
C
C
C -----DEFAULT MAXIMUM NUMBER OF ITERATIONS IF NOT ENTERED
      IF (ITRD.EQ.0) ITRD=20
C

```



```

WRITE(IOUT,310) PERCNT,ITRD .
310 FORMAT ('0 RIVER DEPTH CALCULATION WILL BE WITHIN',
1         F6.2,'% PRECISION'/'0 MAXIMUM NUMBER OF ITERATIONS ',
2         'IN RIVER DEPTH LOOP WILL BE',I4)
C -----CHECK IF ALL RIVER REACHES DO NOT INCLUDE ALLUVIUM
IF (IRVTYP .EQ. 0) GO TO 135
CRIVER
C
C7-----READ AND PRINT DATA FOR EACH RIVER REACH.
CX WRITE(IOUT,3)
CX 3 FORMAT(1H0,15X,'LAYER',5X,'ROW',5X,'COL '
CX 1,' STAGE CONDUCTANCE BOTTOM ELEVATION RIVER REACH'
CX 2/1X,15X,80('-'))
CX DO 250 II=1,NRIVER
CX READ(IN,4)K,I,J,RIVR(4,II),RIVR(5,II),RIVR(6,II)
CX 4 FORMAT(3I10,3F10.0)
CX WRITE(IOUT,5)K,I,J,RIVR(4,II),RIVR(5,II),RIVR(6,II),II
CX 5 FORMAT(1X,15X,I4,I9,I8,G13.4,G14.4,G19.4,I10)
CRIVER
C
C -----READ REACH LOCATION AND UPSTREAM AND DOWNSTREAM REACH(ES)
C AND IF ALLUVIUM IS INCLUDED (IF NO ALLUVIUM, NOAL >0)
DO 40 II=1,NRIVER
READ(IN,15)K,I,J,LDN,LUP1,LUP2,LUP3,LUP4,LUP5,NOAL
15 FORMAT(4I5,6I10)
C
C -----READ DATA FOR RIVER PARAMETERS
READ(IN,20)RIVR(11,II),RIVR(12,II),RIVR(13,II),RIVR(14,II),
1 RIVR(15,II),RIVR(16,II),RIVR(17,II),RIVR(18,II)
20 FORMAT(8G10.4)
C
C -----READ DATA FOR RIVER PARAMETERS
READ(IN,25)RIVR(19,II),RIVR(20,II),RIVR(21,II),RIVR(22,II),
1 RIVR(23,II),RIVR(48,II),RIVR(49,II)
25 FORMAT(7G10.4)
C
C -----IF THERE ARE NO UPSTREAM AND DOWNSTREAM REACHES AND NO VALUE
C FOR SLOPE IS ENTERED, WRITE AN ERROR MESSAGE AND TERMINATE PROGRAM
IF(LDN.EQ.0 .AND. LUP1.EQ.0 ..AND. RIVR(22,II).EQ.0)
1 WRITE(IOUT,27)II
27 FORMAT (1X,'REACH #',I3,' DOES NOT HAVE A RIVER ENERGY GRADIENT',
1 ' ASSIGNMENT'/' ***** IF THERE ARE NO UPSTREAM AND',
2 ' DOWNSTREAM REACHES ASSIGNED YOU MUST ENTER A VALUE FOR',
3 ' ENERGY GRADIENT IN THE RIVER *****'/
4 ' ***** PROGRAM TERMINATED')
IF(LDN.EQ.0 .AND. LUP1.EQ.0 ..AND. RIVR(22,II).EQ.0) STOP
C
C -----READ DATA FOR RIVER FLUXES
READ(IN,28)RIVR(24,II),RIVR(25,II),RIVR(26,II),
1 RIVR(27,II),RIVR(28,II)
28 FORMAT(5G10.4)
C

```

```

C -----READ DATA FOR ALLUVIUM PARAMETERS
  READ(IN,30)RIVR(29,II),RIVR(30,II),RIVR(31,II),RIVR(32,II),
  1      RIVR(33,II),RIVR(34,II),RIVR(35,II),RIVR(36,II)
30 FORMAT(8G10.4)
  IF(LDN.EQ.0.AND.LUP1.EQ.0 ..AND. RIVR(36,II).EQ.0)
  1      WRITE(IOUT,32)II
32 FORMAT (1X,'REACH #',I3,' DOES NOT HAVE AN ALLUVIUM GRADIENT',
  1      ' ASSIGNMENT'/ '***** IF THERE ARE NO UPSTREAM AND',
  2      ' DOWNSTREAM REACHES ASSIGNED YOU MUST ENTER A VALUE FOR',
  3      ' GRADIENT IN THE ALLUVIUM *****'/
  4      ' ***** PROGRAM TERMINATED')
  IF(LDN.EQ.0 .AND. LUP1.EQ.0 ..AND. RIVR(36,II).EQ.0) STOP

C
C -----READ DATA FOR ALLUVIUM FLUXES
  READ(IN,35)RIVR(37,II),RIVR(38,II),RIVR(39,II),
  1      RIVR(40,II),RIVR(41,II),RIVR(42,II)
  35 FORMAT(6G10.4)
CRIVER
  RIVR(1,II)=K
  RIVR(2,II)=I
  RIVR(3,II)=J
CRIVER
  RIVR(4,II)=LDN
  RIVR(5,II)=LUP1
  RIVR(6,II)=LUP2
  RIVR(7,II)=LUP3
  RIVR(8,II)=LUP4
  RIVR(9,II)=LUP5
  RIVR(10,II)=NOAL
  40 CONTINUE

C
C -----PRINT DATA FOR EACH RIVER REACH
  WRITE(IOUT,45)
  45 FORMAT(90('-')/40X,'DOWNSTREAM',14X,'UPSTREAM REACH NOS.'/1H0,2X,
  1      'REACH NO.',3X,'LAYER',4X,'ROW',4X,'COL',7X,'REACH NO.',8X,
  2      '1ST',4X,'2ND',4X,'3RD',4X,'4TH',4X,'5TH'/3X,87('-'))
  DO 55 II=1,NRIVER
  K=RIVR(1,II)
  I=RIVR(2,II)
  J=RIVR(3,II)
  LDN=RIVR(4,II)
  LUP1=RIVR(5,II)
  LUP2=RIVR(6,II)
  LUP3=RIVR(7,II)
  LUP4=RIVR(8,II)
  LUP5=RIVR(9,II)
  WRITE(IOUT,51)II,K,I,J,LDN,LUP1,LUP2,LUP3,LUP4,LUP5
  51 FORMAT(I8,I10,I8,I8,I12,I15,4I7)
  55 CONTINUE

```

C

```

C -----PRINT DATA FOR RIVER PARAMETERS
  WRITE(IOUT,60)
60 FORMAT(/51X,'RIVER PARAMETERS'/109('-')/31X,'BOTTOM',6X,'BOTTOM',
1      8X,'SIDE',5X,'MANNING',16X,'SILT LAY',4X,'SILT LAY'
2      /1H0,2X,'REACH NO.',7X,'STAGE',8X,'ELEV',7X,'WIDTH',7X,
3      'SLOPE',6X,'NUMBER',6X,'LENGTH',4X,'HYD COND',7X,'THICK'
4      /3X,106('-'))
  DO 70 II=1,NRIVER
  WRITE(IOUT,65)II,RIVR(11,II),RIVR(12,II),RIVR(13,II),RIVR(14,II),
1      RIVR(15,II),RIVR(16,II),RIVR(17,II),RIVR(18,II)
65 FORMAT(I8,F16.2,2F12.2,2F12.4,F12.2,G12.4,F12.4)
70 CONTINUE

```

C

```

C -----PRINT DATA FOR RIVER PARAMETERS
  WRITE(IOUT,71)
71 FORMAT(/28X,'RIVER PARAMETERS'/
1      97('-')/15X,'SILT GAIN',3X,'SILT GAIN',3X,'AIR ENTRY',7X,
2      'ENERGY',4X,'SEEPAGE',5X,'BEDROCK',5X,'BEDROCK'/1H0,2X,
3      'REACH NO.',4X,'HYD COND',7X,'THICK',4X,'PRESSURE',5X,
4      'GRADIENT',3X,'DISTANCE',5X,'HY COND',5X,'BOT ELEV'/3X,
5      94('-'))
  DO 80 II=1,NRIVER

```

C

```

C -----DEFAULT GAINING SILT LAYER HYDRAULIC CONDUCTIVITY AND THICKNESS
C TO VALUE FOR LOSING CONDITIONS IF USER ENTERED A NEGATIVE NUMBER
  IF (RIVR(19,II).LT.0.0) RIVR(19,II)=RIVR(17,II)
  IF (RIVR(20,II).LT.0.0) RIVR(20,II)=RIVR(18,II)
  WRITE(IOUT,75)II,RIVR(19,II),RIVR(20,II),RIVR(21,II),RIVR(22,II),
1      RIVR(23,II),RIVR(48,II),RIVR(49,II)
75 FORMAT(I8,G16.4,F12.4,2F12.4,F12.2,2G12.5)
80 CONTINUE

```

C

```

C -----PRINT DATA FOR RIVER FLUXES
  WRITE(IOUT,85)
85 FORMAT(/25X,'RIVER FLUXES (CFS OR CMS)'/73('-')/28X,
1      'RETURN',29X,'OUTSIDE'/1H0,2X,'REACH NO.',2X,
2      'DIVERSIONS',6X,'FLOW',6X,'PRECIP',8X,'EVAP',8X,'FLOW'/
3      3X,70('-'))
  DO 95 II=1,NRIVER
  WRITE(IOUT,90)II,RIVR(24,II),RIVR(25,II),RIVR(26,II),RIVR(27,II),
1      RIVR(28,II)
90 FORMAT(I8,G16.4,3G12.4,F12.4)
95 CONTINUE

```

C

```

C -----PRINT DATA FOR ALLUVIUM PARAMETERS
  WRITE(IOUT,105)
105 FORMAT(/45X,'ALLUVIUM PARAMETERS'/109('-')/19X,'POTEN',6X,
1      'BOTTOM',53X,'SEEPAGE'/1H0,2X,'REACH NO.',8X,'HEAD',
2      8X,'ELEV',7X,'WIDTH',6X,'LENGTH',4X,'HYD COND',4X,
3      'SP YIELD',4X,'DISTANCE',4X,'GRADIENT',/3X,106('-'))
  DO 115 II=1,NRIVER

```

C

```

C -----DEFAULT ALLUVIUM LENGTH TO RIVER LENGTH IF USER DID NOT ENTER A
VALUE
      IF(RIVR(32,II).LE.0) RIVR(32,II)=RIVR(16,II)
      WRITE(IOUT,110) II,RIVR(29,II),RIVR(30,II),RIVR(31,II),RIVR(32,II),
1      RIVR(33,II),RIVR(34,II),RIVR(35,II),RIVR(36,II)
110  FORMAT(I8,F16.2,3F12.2,G12.4,2F12.4,F12.4)
115  CONTINUE
C
C -----PRINT DATA FOR ALLUVIUM FLUXES
      WRITE(IOUT,120)
120  FORMAT(/42X,'ALLUVIUM FLUXES'/85('-')/41X,'ET SURF',
1      2X,'ET EXTINGUISH',3X,'WTDRAWL(-)',2X,'DOWNSTREAM'/
2      1H0,2X,'REACH NO.',4X,'RECHARGE',5X,'ET RATE'8X,'ELEV',
3      8X,'ELEV',3X,'INJECT(+)',2X,'DISCHARGE'/3X,82('-'))
      DO 130 II=1,NRIVER
      WRITE(IOUT,125) II,RIVR(37,II),RIVR(38,II),RIVR(39,II),
1      RIVR(40,II),RIVR(41,II),RIVR(42,II)
125  FORMAT(I8,G16.4,G12.4,2F12.2,F12.4,F12.3)
130  CONTINUE
      DO 230 K=1,NRIVER
230  CONTINUE
      RETURN
CRIVER
C*****
C *****
C -----READ ONLY IF ALL RIVER REACHES DO NOT INCLUDE ALLUVIUM (IRVTYP=0)
C*****
C *****
C
C -----READ REACH LOCATION AND UPSTREAM AND DOWNSTREAM REACH(ES)
135  DO 165 II=1,NRIVER
      READ(IN,140) K,I,J,LDN,LUP1,LUP2,LUP3,LUP4,LUP5
140  FORMAT(4I5,5I10)
C -----READ DATA FOR RIVER PARAMETERS
      READ(IN,145) RIVR(11,II),RIVR(12,II),RIVR(13,II),RIVR(14,II),
1      RIVR(15,II),RIVR(16,II),RIVR(17,II),RIVR(18,II)
145  FORMAT(8G10.4)
C
C -----READ DATA FOR RIVER PARAMETERS
      READ(IN,150) RIVR(19,II),RIVR(20,II),RIVR(21,II),RIVR(22,II),
1      RIVR(23,II),RIVR(48,II),RIVR(49,II)
150  FORMAT(7G10.4)
C
C -----IF THERE ARE NO UPSTREAM AND DOWNSTREAM REACHES AND NO VALUE
FOR SLOPE IS ENTERED, WRITE AN ERROR MESSAGE AND TERMINATE PROGRAM
C      IF(LDN.EQ.0 .AND. LUP1.EQ.0 ..AND. RIVR(22,II).EQ.0)
1      WRITE(IOUT,155) II
155  FORMAT (' REACH #',I3,' ***** IF THERE ARE NO UPSTREAM AND',
1      ' DOWNSTREAM REACHES ASSIGNED YOU MUST ENTER A VALUE FOR',
2      ' ENERGY GRADIENT IN THE RIVER *****')
      IF(LDN.EQ.0 .AND. LUP1.EQ.0 ..AND. RIVR(22,II).EQ.0) STOP
C

```

```

C -----READ DATA FOR RIVER FLUXES
  READ(IN,160)RIVR(24,II),RIVR(25,II),RIVR(26,II),
  1      RIVR(27,II),RIVR(28,II)
160 FORMAT(5G10.4)
CRIVER
  RIVR(1,II)=K
  RIVR(2,II)=I
  RIVR(3,II)=J
CRIVER
  RIVR(4,II)=LDN
  RIVR(5,II)=LUP1
  RIVR(6,II)=LUP2
  RIVR(7,II)=LUP3
  RIVR(8,II)=LUP4
  RIVR(9,II)=LUP5
165 CONTINUE
C
C -----PRINT DATA FOR EACH RIVER REACH
  WRITE(IOUT,170)
170 FORMAT(90('-')/40X,'DOWNSTREAM',14X,'UPSTREAM REACH NOS.'/1H0,2X,
  1      'REACH NO.',3X,'LAYER',4X,'ROW',4X,'COL',7X,'REACH NO.',8X,
  2      '1ST',4X,'2ND',4X,'3RD',4X,'4TH',4X,'5TH'/3X,87('-'))
  DO 180 II=1,NRIVER
  K=RIVR(1,II)
  I=RIVR(2,II)
  J=RIVR(3,II)
  LDN=RIVR(4,II)
  LUP1=RIVR(5,II)
  LUP2=RIVR(6,II)
  LUP3=RIVR(7,II)
  LUP4=RIVR(8,II)
  LUP5=RIVR(9,II)
  WRITE(IOUT,51)II,K,I,J,LDN,LUP1,LUP2,LUP3,LUP4,LUP5
175 FORMAT(I8,I10,I8,I8,I12,I15,4I7)
180 CONTINUE
C
C -----PRINT DATA FOR RIVER PARAMETERS
  WRITE(IOUT,185)
185 FORMAT(/51X,'RIVER PARAMETERS'/109('-')/31X,'BOTTOM',6X,'BOTTOM',
  1      8X,'SIDE',5X,'MANNING',16X,'SILT LAY',4X,'SILT LAY'
  2      /1H0,2X,'REACH NO.',7X,'STAGE',8X,'ELEV',7X,'WIDTH',7X,
  3      'SLOPE',6X,'NUMBER',6X,'LENGTH',4X,'HYD COND',7X,'THICK'
  4      /3X,106('-'))
  DO 195 II=1,NRIVER
  WRITE(IOUT,190)II,RIVR(11,II),RIVR(12,II),RIVR(13,II),RIVR(14,II),
  1      RIVR(15,II),RIVR(16,II),RIVR(17,II),RIVR(18,II)
190 FORMAT(I8,F16.2,2F12.2,2F12.4,F12.2,G12.4,F12.4)
195 CONTINUE
C

```

```

C -----PRINT DATA FOR RIVER PARAMETERS
  WRITE(IOUT,200)
  200 FORMAT(/28X,'RIVER PARAMETERS'/
  1      97('-')/15X,'SILT GAIN',3X,'SILT GAIN',3X,'AIR ENTRY',7X,
  2      'ENERGY',4X,'SEEPAGE',5X,'BEDROCK',5X,'BEDROCK'/1H0,2X,
  3      'REACH NO.',4X,'HYD COND',7X,'THICK',4X,'PRESSURE',5X,
  4      'GRADIENT',3X,'DISTANCE',5X,'HY COND',5X,'BOT ELEV'/3X,
  5      94('-'))
  DO 210 II=1,NRIVER

C
C -----DEFAULT GAINING SILT LAYER HYDRAULIC CONDUCTIVITY AND THICKNESS
C TO VALUE FOR LOSING CONDITIONS IF USER ENTERED A NEGATIVE NUMBER
  IF (RIVR(19,II).LT.0.0) RIVR(19,II)=RIVR(17,II)
  IF (RIVR(20,II).LT.0.0) RIVR(20,II)=RIVR(18,II)
  WRITE(IOUT,205) II,RIVR(19,II),RIVR(20,II),RIVR(21,II),
  1      RIVR(22,II),RIVR(23,II),RIVR(48,II),RIVR(49,II)
  205 FORMAT(I8,G16.4,F12.4,2F12.4,F12.2,2F12.5)
  210 CONTINUE

C
C -----PRINT DATA FOR RIVER FLUXES
  WRITE(IOUT,215)
  215 FORMAT(/25X,'RIVER FLUXES (CFS OR CMS)'/73('-')/28X,
  1      'RETURN',29X,'OUTSIDE'/1H0,2X,'REACH NO.',2X,
  2      'DIVERSIONS',6X,'FLOW',6X,'PRECIP',8X,'EVAP',8X,'FLOW'/
  3      3X,70('-'))
  DO 225 II=1,NRIVER
  WRITE(IOUT,220) II,RIVR(24,II),RIVR(25,II),RIVR(26,II),RIVR(27,II),
  1      RIVR(28,II)
  220 FORMAT(I8,G16.4,3G12.4,F12.4)
  225 CONTINUE

CRIVER
C8-----RETURN
  260 RETURN
  END

C
CRIVER
CX  SUBROUTINE RIV1FM(NRIVER,MXRIVR,RIVR,HNEW,HCOF,RHS,IBOUND,
CX  1      NCOL,NROW,NLAY)
CRIVER

```

```

          SUBROUTINE RINT1FM(IOUT, NRIVER, MXRIVR, RIVR, HNEW, HCOF, RHS,
1              IBOUND, NCOL, NROW, NLAY, IRVTYP)
CRIVER
C
CX----VERSION 0915 27AUG1982 RIV1FM
CRIVER
C -----RIVINT VERSION JAN1990  J. SCHENK & E. POETER
CRIVER
C *****
C ADD RIVER TERMS TO RHS AND HCOF
C *****
C
C SPECIFICATIONS:
C -----
C
C
C DOUBLE PRECISION HNEW
CX DIMENSION RIVR(6, MXRIVR), HNEW(NCOL, NROW, NLAY),
CX 1          HCOF(NCOL, NROW, NLAY), RHS(NCOL, NROW, NLAY),
CX 2          IBOUND(NCOL, NROW, NLAY),
CRIVER
          DIMENSION RIVR(49, MXRIVR), HNEW(NCOL, NROW, NLAY),
          1          HCOF(NCOL, NROW, NLAY), RHS(NCOL, NROW, NLAY),
          2          IBOUND(NCOL, NROW, NLAY)
CRIVER
C -----
C
C
C1-----IF NRIVER<=0 THERE ARE NO RIVERS. RETURN.
          IF(NRIVER.LE.0) RETURN
C
C
C
C
CRIVER
C
C2-----PROCESS EACH CELL IN THE RIVER LIST.
          DO 155 L=1, NRIVER
C
C3-----GET COLUMN, ROW, AND LAYER OF CELL CONTAINING REACH
          IL=RIVR(1, L)
          IR=RIVR(2, L)
          IC=RIVR(3, L)
C
C4-----IF THE CELL IS EXTERNAL SKIP IT.
          IF(IBOUND(IC, IR, IL).LE.0) GO TO 155
C
C5-----SINCE THE CELL IS INTERNAL GET THE RIVER DATA.
CX HRIV=RIVR(4, L)
CX CRIV=RIVR(5, L)
CX RBOT=RIVR(6, L)
          HHNEW=HNEW(IC, IR, IL)

```

CRIVER

LUP1=RIVR(5,L)
LUP2=RIVR(6,L)
LUP3=RIVR(7,L)
LUP4=RIVR(8,L)
LUP5=RIVR(9,L)
NOAL=RIVR(10,L)
HRIV=RIVR(11,L)
RBOT=RIVR(12,L)
BWID=RIVR(13,L)
SIDE=RIVR(14,L)
RLNG=RIVR(16,L)
SHY=RIVR(17,L)
THS=RIVR(18,L)
SGHY=RIVR(19,L)
THSG=RIVR(20,L)
HNEG=RIVR(21,L)
RSPDST=RIVR(23,L)
BHY=RIVR(48,L)
BBOT=RIVR(49,L)

C
C -----INITIALIZE VALUES FOR FLOW COMING FROM UPSTREAM ALLUVIUM

QADN1=0.0
QADN2=0.0
QADN3=0.0
QADN4=0.0
QADN5=0.0

C
C -----CHECK IF ALL REACHES DO NOT INCLUDE ALLUVIUM
IF(IRVTYP .EQ. 0) GO TO 105

C
C -----CHECK IF THIS REACH INCLUDES ALLUVIUM
IF IT DOES, DO NOT ADD VALUE OF QADN TO GROUNDWATER GRID BLOCK
IF (NOAL .LE. 0) GO TO 80

C
C -----CHECK IF THERE IS A VALUE FOR QADN IN THE UPSTREAM REACH
QADN1A=RIVR(42,LUP1)
QADN2A=RIVR(42,LUP2)
QADN3A=RIVR(42,LUP3)
QADN4A=RIVR(42,LUP4)
QADN5A=RIVR(42,LUP5)

C
C -----IF THERE IS AN UPSTREAM REACH AND THERE IS A VALUE FOR QADN
IN THAT REACH, MAKE CORRECT ASSIGNMENT
IF(LUP1.NE.0 .AND. QADN1A.NE.0) QADN1=QADN1A
IF(LUP2.NE.0 .AND. QADN1A.NE.0) QADN2=QADN2A
IF(LUP3.NE.0 .AND. QADN1A.NE.0) QADN3=QADN3A
IF(LUP4.NE.0 .AND. QADN1A.NE.0) QADN4=QADN4A
IF(LUP5.NE.0 .AND. QADN1A.NE.0) QADN5=QADN5A

C
C -----BECAUSE THIS REACH DOES NOT INCLUDE ALLUVIUM, GO PAST THE NEXT
SECTION
GO TO 105

```

C
  80 HAL=RIVR(29,L)
    ABOT=RIVR(30,L)
    WIDA=RIVR(31,L)
    ALNG=RIVR(32,L)
    AHY=RIVR(33,L)
    ASPDST=RIVR(35,L)
CRIVER
C
C6-----COMPARE AQUIFER HEAD TO BOTTOM OF STREAM BED.
CX   IF(HHNEW.LE.RBOT)GO TO 96
C
C7-----SINCE HEAD>BOTTOM ADD TERMS TO RHS AND HCOF.
CX   RHS(IC,IR,IL)=RHS(IC,IR,IL)-CRIV*HRIV
CX   HCOF(IC,IR,IL)=HCOF(IC,IR,IL)-CRIV
CX   GO TO 100
C
C8-----SINCE HEAD<BOTTOM ADD TERM ONLY TO RHS.
CX 96 RHS(IC,IR,IL)=RHS(IC,IR,IL)-CRIV*(HRIV-RBOT)
CRIVER
C
C -----IF NO SEEPAGE DISTANCE IS ENTERED FOR ALLVIUM/BEDROCK, DEFAULT
      IF(ASPDST.EQ.0.0)ASPDST=0.5*(HAL-BBOT)
C
C -----CHECK FOR CONDITION OF NO SEEPAGE - ALLUVIUM IS DRY AND HEAD IN
C       BEDROCK IS BELOW BOTTOM OF ALLUVIUM -- IF SO GO ON TO NEXT REACH
C       IF(HAL.EQ.ABOT .AND. HHNEW.LE.ABOT) GO TO 155
C
C -----CHECK FOR UNSATURATED FLOW
C       ALLUVIUM IS NOT DRY AND HEAD IN BEDROCK AQUIFER IS
C       BELOW BOTTOM OF ALLUVIUM
C       IF(HAL.NE.ABOT .AND. HHNEW.LT.ABOT) GO TO 90
C
C -----CHECK FOR SATURATED FLOW WITH DRY ALLVIUM
C       HEAD>BOTTOM OF ALLUVIUM
C       IF(HAL.EQ.ABOT .AND. HHNEW.GT.ABOT) GO TO 85
C
C -----SATURATED FLOW - CALCULATE EQUIVALENT HYDRAULIC CONDUCTIVITY
C       BETWEEN ALLUVIUM AND BEDROCK (WEIGHTED HARMONIC MEAN)
C       EQVK = (HAL-BBOT) / ((HAL-ABOT)/AHY + (ABOT-BBOT)/BHY)
C
C -----CALCULATE CONDUCTANCE BETWEEN ALLUVIUM AND BEDROCK AQUIFER
C       CAL=EQVK*WIDA*ALNG/ASPDST
C
C -----MAKE NEW ASSIGNMENT
C       RIVR(46,L)=CAL
C       GO TO 95
C
C -----SATURATED FLOW - DRY ALLUVIUM AND HEAD IN BEDROCK AQUIFER
C       IS ABOVE BOTTOM OF ALLUVIUM
C       CALCULATE EQUIVALENT HYDRAULIC CONDUCTIVITY
C       85 EQVK2 = (HHNEW-BBOT) / ((HHNEW-ABOT)/AHY + (ABOT-BBOT)/BHY)
C
C -----CALCULATE CONDUCTANCE BETWEEN ALLUVIUM AND BEDROCK AQUIFER

```

```

      CAL = EQVK2*WIDA*ALNG/ASPDST
C
C -----MAKE NEW ASSIGNMENT
      RIVR(46,L)=CAL
      GO TO 95
C
C -----CALCULATE CONDUCTANCE BETWEEN ALLUVIUM AND BEDROCK - UNSATURATED
FLOW
C      GRADIENT = 1 FOR UNSATURATED FLOW
      90 CAL=BHY*WIDA*ALNG/(HAL-ABOT)
C
C -----MAKE NEW ASSIGNMENT
      RIVR(46,L)=CAL
C
C -----SINCE HEAD IN BEDROCK AQUIFER < BOTTOM OF ALLUVIUM ADD TERM ONLY TO
RHS
      RHS(IC,IR,IL)=RHS(IC,IR,IL)-CAL*(HAL-ABOT)
      GO TO 155
C
C -----SINCE HEAD IN BDRK > BOT OF ALLUV ADD TERMS TO RHS AND HCOF
      95 RHS(IC,IR,IL)=RHS(IC,IR,IL)-(CAL*HAL)
      HCOF(IC,IR,IL)=HCOF(IC,IR,IL)-CAL
      GO TO 155
C
C
*****
C *****THE FOLLOWING CALCULATIONS ARE FOR RIVER REACHES WITHOUT
ALLUVIUM*****
C
*****
C -----TEST FOR GAINING RIVER
      105 IF (HHNEW .GT. HRIV) GO TO 130
C
C -----CALCULATE TRUE RIVER BOTTOM FOR LOSING RIVER
      RIVBOT = RBOT + THS
C
C -----MAKE NEW ASSIGNMENT
      RIVR(45,L)=RIVBOT
C
C -----IF RIVER IS DRY AND HEAD IS BELOW RIVER BOTTOM - NO SEEPAGE
      GO TO NEXT REACH
      IF (HRIV.LE.RIVBOT .AND. HHNEW.LE.RIVBOT) GO TO 155
C
C -----TEST FOR LOSING RIVER - NO HYDRAULIC CONNECTION
      IF (HHNEW.LT.RIVBOT) GO TO 115
C
C *****
C -----LOSING RIVER - HYDRAULICALLY CONNECTED
C *****
C
C -----IF SEEPAGE DISTANCE NOT ENTERED, DEFAULT
      IF (RSPDST .EQ. 0) RSPDST= 0.5*(RBOT-BBOT)+THS

```

```

C
C -----CHECK IF SILT LAYER IS PRESENT
      IF (SHY.EQ.0.0) GO TO 110
C
C -----CALCULATE EQUIVALENT HYDRAULIC CONDUCTIVITY IF SILT LAYER PRESENT
      SBEQVK = (RIVBOT-BBOT) / (THS/SHY+(RBOT-BBOT)/BHY)
C
C -----CALCULATE RIVER CONDUCTANCE
      CRIV=SBEQVK * (BWID+(2.0*(HRIV-RIVBOT)/SIDE))*RLNG / RSPDST
C
C -----MAKE NEW ASSIGNMENT
      RIVR(47,L)=CRIV
      GO TO 150
C
C -----CALCULATE RIVER CONDUCTANCE IF NO SILT LAYER IS PRESENT
110 CRIV = BHY * (BWID+(2.0*(HRIV-RIVBOT)/SIDE))*RLNG
      1 / RSPDST
C
C -----MAKE NEW ASSIGNMENT
      RIVR(47,L)=CRIV
      GO TO 150
C
C*****
C -----LOSING RIVER - NO HYDRAULIC CONNECTION
C*****
C
C -----CHECK IF SILT LAYER IS PRESENT
115 IF(SHY.EQ.0.0) GO TO 120
C
C -----CALCULATE RIVER CONDUCTANCE - SILT LAYER PRESENT
      CRIV = SHY * (BWID+(2.0*(HRIV-RIVBOT)/SIDE))*RLNG / THS
C
C -----MAKE NEW ASSIGNMENT
      RIVR(47,L)=CRIV
C
C -----SINCE HEAD<RIVER BOTTOM ADD TERM ONLY TO RHS.
      RHS(IC,IR,IL)=RHS(IC,IR,IL)-CRIV*(HRIV-RIVBOT+HNEG)
      1 -QADN1-QADN2-QADN3-QADN4-QADN5
      GO TO 155
C
C -----CALCULATE RIVER CONDUCTANCE - NO SILT LAYER
120 CRIV = BHY * (BWID+(2.0*(HRIV-RIVBOT)/SIDE))*RLNG
      1 / (HRIV-RIVBOT)
C
C -----MAKE NEW ASSIGNMENT
      RIVR(47,L)=CRIV
C
C8-----SINCE HEAD<RIVER BOTTOM ADD TERM ONLY TO RHS.
125 RHS(IC,IR,IL)=RHS(IC,IR,IL)-CRIV*(HRIV-RIVBOT)
      1 -QADN1-QADN2-QADN3-QADN4-QADN5
      GO TO 155
C *****
C -----GAINING RIVER
C *****

```

```

C
C -----CALCULATE TRUE RIVER BOTTOM FOR GAINING RIVER
130 RIVBOT= RBOT + THSG
C
C -----MAKE NEW ASSIGNMENT
RIVR(45,L)=RIVBOT
C
C -----IF SEEPAGE DISTANCE NOT SPECIFIED, DEFAULT
IF (RSPDST .EQ. 0) RSPDST = 0.5*(RBOT-BBOT) +THSG
C
C -----IF SILT GAIN. HY. COND. NOT SPECIFIED, ASSUME NO SILT LAYER
C IS PRESENT WHEN CALCULATING RIVER CONDUCTANCE
C IF(SGHY.EQ.0.0) GO TO 140
C
C -----THE FOLLOWING SEEPAGE CALCULATIONS INVOLVE A SILT LAYER
C -----CALCULATE EQUIVALENT HYDRAULIC CONDUCTIVITY
SBEQVK = (RIVBOT-BBOT) / (THSG/SGHY + (RBOT-BBOT)/BHY)
C
C -----CALCULATE RIVER CONDUCTANCE - SATURATED CONDITIONS
CRIV = SBEQVK * (BWID+(2.0*(HRIV-RIVBOT)/SIDE)) *
1 RLNG / RSPDST
C
C -----MAKE NEW ASSIGNMENT
RIVR(47,L)=CRIV
GO TO 150
C
C -----THE FOLLOWING SEEPAGE CALCULATIONS ASSUME NO SILT LAYER PRESENT
C -----CALCULATE RIVER CONDUCTANCE - GAINING RIVER NO SILT LAYER
140 CRIV = BHY * (BWID+(2.0*(HRIV-RIVBOT)/SIDE)) *
1 RLNG / RSPDST
C
C -----MAKE NEW ASSIGNMENT
RIVR(47,L)=CRIV
GO TO 150
C
C -----SINCE HEAD>RIVER BOTTOM ADD TERMS TO RHS AND HCOF.
C THIS CALCULATION ALSO INCLUDES ANY FLUX INTO THE GROUNDWATER
C CELL FROM AN UPSTREAM ALLUVIUM REACH(ES) (QADN1 THRU QADN4)
150 RHS(IC,IR,IL)=RHS(IC,IR,IL)-(CRIV*HRIV)-QADN1-QADN2-QADN3
1 -QADN4-QADN5
HCOF(IC,IR,IL)=HCOF(IC,IR,IL)-CRIV
155 CONTINUE
C9-----RETURN
RETURN
END
C
C

```

```

CX      SUBROUTINE RIV1BD(NRIVER, MXRIVR, RIVR, IBOUND, HNEW,
CX      1          NCOL, NROW, NLAY, DELT, VBVL, VBNM, MSUM, KSTP, KPER, IRIVCB,
CX      2          ICBCFL, BUFF, IOUT)
CRIVER
      SUBROUTINE RINT1BD(NRIVER, MXRIVR, RIVR, IBOUND, HNEW,
      1          NCOL, NROW, NLAY, DELT, VBVL, VBNM, MSUM, KSTP, KPER,
      2          IRIVCB, ICBCFL, BUFF, IOUT, IRVTYP,
      3          ISI, DTOLD, ITRD, ITMUNI)
C -----VERSION - RIVINT - J. SCHENK & E. POETER - JANUARY 1990
CRIVER
CXC-----VERSION 1256 28DEC1983 RIV1BD
C      *****
C      CALCULATE VOLUMETRIC BUDGET FOR RIVERS
C      *****
C
C      SPECIFICATIONS:
C      -----
C      DOUBLE PRECISION HNEW
CX      DIMENSION RIVR(6, MXRIVR), IBOUND(NCOL, NROW, NLAY),
CX      1          HNEW(NCOL, NROW, NLAY), VBVL(4, 20),
CX      2          BUFF(NCOL, NROW, NLAY),
CRIVER
      DIMENSION RIVR(49, MXRIVR), IBOUND(NCOL, NROW, NLAY),
      1          HNEW(NCOL, NROW, NLAY), VBVL(4, 20),
      2          BUFF(NCOL, NROW, NLAY)
CRIVER
CF66
C      DIMENSION TEXT(4), VBNM(4, 20)
CF66
CF77
      CHARACTER*4 TEXT(4), VBNM(4, 20)
CF77
      DATA TEXT(1), TEXT(2), TEXT(3), TEXT(4) /' R', 'IVER', ' LEA', 'KAGE'/
      OPEN(UNIT=8, FILE='SLOPE.OUT')
C      -----
C
C1-----INITIALIZE CELL-BY-CELL FLOW TERM FLAG (IBD) AND
C1-----ACCUMULATORS (RATIN AND RATOUT).
      IBD=0
      RATIN=0.
      RATOUT=0.
C
C2-----IF NO REACHES KEEP ZEROES IN ACCUMULATORS.
      IF(NRIVER.EQ.0)GO TO 115
C
C3-----TEST TO SEE IF CELL-BY-CELL FLOW TERMS ARE NEEDED.
      IF(ICBCFL.EQ.0 .OR. IRIVCB.LE.0 ) GO TO 10
C

```

```

C3A-----CELL-BY-CELL FLOW TERMS ARE NEEDED SET IBD AND CLEAR BUFFER.
      IBD=1
      DO 5 IL=1,NLAY
      DO 5 IR=1,NROW
      DO 5 IC=1,NCOL
      BUFF(IC,IR,IL)=0.
      5 CONTINUE
C4-----FOR EACH RIVER REACH ACCUMULATE RIVER FLOW (STEPS 5-15)
CX 10 DO 100 L=1,NRIVER
CRIVER
CRIVER
C -----CONVERT TIME UNITS TO SECONDS
C       THIS IS DONE SO THAT QRA WILL BE CONVERTED TO SECONDS FOR THE
C       CALCULATION OF QR, AND QR WILL BE REPORTED IN CFS OR CMS
C       TIME UNIT INPUT (ITMUNI)
C       1 = SECONDS
C       2 = MINUTES
C       3 = HOURS
C       4 = DAYS
C       5 = YEARS
C
C 10 IF (ITMUNI.EQ.1) SEC = 1.0
      IF (ITMUNI.EQ.2) SEC = 60.0
      IF (ITMUNI.EQ.3) SEC = 3600.0
      IF (ITMUNI.EQ.4) SEC = .864E+05
      IF (ITMUNI.EQ.5) SEC = .31536E+08
C
C -----CHECK FOR METRIC OR ENGLISH UNITS
C       C = 1.49
C       IF (ISI.EQ.1) C = 1.0
C
C
C *****
C ***** BEGIN LOOP FOR CALCULATION OF ENERGY GRADIENT IN RIVER *****
C               AND IF REACH CONTAINS ALLUVIUM, GRADIENT IN ALLUVIUM
C *****
C *****
      DO 38 I=1,NRIVER
CRIVER
C
C5-----GET LAYER, ROW & COLUMN OF CELL CONTAINING REACH.
      IL=RIVR(1,I)
      IR=RIVR(2,I)
      IC=RIVR(3,I)
C
C6-----IF CELL IS EXTERNAL MOVE ON TO NEXT REACH.
CX  IF(IBOUND(IC,IR,IL).LE.0)GO TO 100
CRIVER
      IF(IBOUND(IC,IR,IL).LE.0)GO TO 38
C

```

```

C -----GET PARAMETERS FROM RIVER LIST
  LDN =RIVR(4,I)
  LUP1=RIVR(5,I)
  LUP2=RIVR(6,I)
  LUP3=RIVR(7,I)
  LUP4=RIVR(8,I)
  LUP5=RIVR(9,I)
  NOAL=RIVR(10,I)
  HRIV=RIVR(11,I)
  RLNG=RIVR(16,I)
  RSLP=RIVR(22,I)

C
C -----ASSIGN UPSTREAM PARAMETER INFORMATION
C -----HEAD IN RIVER - UPSTREAM REACHES
  HRVUP1=RIVR(11,LUP1)
  HRVUP2=RIVR(11,LUP2)
  HRVUP3=RIVR(11,LUP3)
  HRVUP4=RIVR(11,LUP4)
  HRVUP5=RIVR(11,LUP5)

C
C -----LENGTH OF RIVER - UPSTREAM REACHES
  RLNUP1=RIVR(16,LUP1)
  RLNUP2=RIVR(16,LUP2)
  RLNUP3=RIVR(16,LUP3)
  RLNUP4=RIVR(16,LUP4)
  RLNUP5=RIVR(16,LUP5)

C
C -----ASSIGN DOWNSTREAM PARAMETER INFORMATION
C -----HEAD IN RIVER - DOWNSTREAM REACH
  HRIVDN=RIVR(11,LDN)

C
C -----LENGTH OF RIVER - DOWNSTREAM REACH
  RLNGDN=RIVR(16,LDN)
  IF(I.EQ.194)WRITE(IOUT,801)HRVUP1,HRVUP2,RLNUP1,RLNUP2,HRIVDN,
1      RLNGDN
801  FORMAT('HRVUP1=',F12.2,3X,'HRVUP2=',F12.2,3X,'RLNUP1=',F12.2,
1      3X,'RLNUP2=',F12.2,3X,'HRIVDN=',F12.2,3X,
2      'RLNGDN=',F12.2)

C
C*****
C -----CALCULATE ENERGY GRADIENT OF RIVER
C*****
C
C -----CHECK IF NO UPSTREAM OR DOWNSTREAM REACHES - ENERGY GRADIENT SHOULD
C      BE ENTERED IN INPUT IF THIS CONDITION EXISTS
  IF (LUP1.EQ.0 .AND. LDN.EQ.0) GO TO 38

C
C -----CHECK IF NO UPSTREAM REACHES BUT THERE IS A DOWNSTREAM REACH
  IF (LUP1.EQ.0 .AND. LDN.NE.0) GO TO 26

C
C -----CHECK FOR TWO UPSTREAM REACHES
  IF (LUP1.NE.0 .AND. LUP2.NE.0 .AND. LUP3.EQ.0) GO TO 20

C

```

```

C -----CHECK FOR THREE UPSTREAM REACHES
  IF (LUP1.NE.0 .AND. LUP2.NE.0 .AND. LUP3.NE.0 .AND. LUP4.EQ.0)
1    GO TO 21
C
C -----CHECK FOR FOUR UPSTREAM REACHES
  IF (LUP1.NE.0 .AND. LUP2.NE.0 .AND. LUP3.NE.0 .AND. LUP4.NE.0
1    .AND. LUP5.EQ.0) GO TO 22
C
C -----CHECK FOR FIVE UPSTREAM REACHES
  IF (LUP1.NE.0 .AND. LUP2.NE.0 .AND. LUP3.NE.0 .AND. LUP4.NE.0
1    .AND. LUP5.NE.0) GO TO 23
C
C -----HEAD AND LENGTH FOR ONE UPSTREAM REACH
  HRAVUP = HRVUP1
  DRAVUP = RLNUP1
  GO TO 24
C
C -----CALCULATE AVG HEAD AND LENGTH FOR TWO UPSTREAM REACHES
20  HRAVUP = (HRVUP1+HRVUP2) / 2.0
    DRAVUP = (RLNUP1+RLNUP2) / 2.0
    GO TO 24
C
C -----CALCULATE AVG HEAD AND AVG LENGTH FOR THREE UPSTREAM REACHES
21  HRAVUP = (HRVUP1+HRVUP2+HRVUP3) / 3.0
    DRAVUP = (RLNUP1+RLNUP2+RLNUP3) / 3.0
    GO TO 24
C
C -----CALCULATE AVG HEAD AND AVG LENGTH FOR FOUR UPSTREAM REACHES
22  HRAVUP = (HRVUP1+HRVUP2+HRVUP3+HRVUP4) / 4.0
    DRAVUP = (RLNUP1+RLNUP2+RLNUP3+RLNUP4) / 4.0
    GO TO 24
C
C -----CALCULATE AVG HEAD AND AVG LENGTH FOR FIVE UPSTREAM REACHES
23  HRAVUP = (HRVUP1+HRVUP2+HRVUP3+HRVUP4+HRVUP5) / 5.0
    DRAVUP = (RLNUP1+RLNUP2+RLNUP3+RLNUP4+RLNUP5) / 5.0
C
C -----CHECK IF THERE IS A DOWNSTREAM REACH
24  IF (LDN.EQ.0) GO TO 25
C
C -----CALCULATE ENERGY GRADIENT IF THERE ARE UPSTREAM REACH(ES)
C     AND A DOWNSTREAM REACH
    RSLP = (HRAVUP-HRIVDN) / (0.5*DRAVUP+RLNG+0.5*RLNGDN)
    GO TO 27
C
C -----CALCULATE ENERGY GRADIENT IF THERE IS AN UPSTREAM REACH(ES)
C     BUT NO DOWNSTREAM REACH
25  RSLP = (HRAVUP-HRIV) / (0.5*(DRAVUP+RLNG))
    GO TO 27
C
C -----CALCULATE ENERGY GRADIENT IF THERE ARE NO UPSTREAM REACHES BUT
C     THERE IS A DOWNSTREAM REACH
26  RSLP = (HRIV-HRIVDN) / (0.5*(RLNG+RLNGDN))
C

```



```

C -----IF ENERGY GRADIENT OF RIVER IS CALCULATED TO BE ZERO OR NEGATIVE
C       WRITE AND ERROR MESSAGE AND TERMINATE PROGRAM
C       27 IF (RSLP.LE.0)WRITE(IOUT,127) I,RSLP
127  FORMAT('0 REACH #',I3,5X,'ENERGY GRADIENT OF RIVER = ',F10.6/
      1  '0 ENERGY GRADIENT MUST BE GREATER THAN ZERO - CHECK INPUT'
      2  ' PARAMETERS'/'0 IF GRADIEMT IS ZERO, AVERAGE HEAD IN UPSTREAM'
      3  ' REACH OR HEAD IN DOWNSTREAM REACH IS EQUAL TO HEAD IN THIS '
      4  'REACH'/ '***** PROGRAM TERMINATED')
C
C -----ABNORMAL STOP IF ENERGY GRADIENT IS <= 0
C       IF (RSLP.LE.0)STOP
C
C -----MAKE NEW ASSIGNMENT
C       RIVR(22,I)=RSLP
C       WRITE(8,500)I,RSLP
500  FORMAT('L=',I3,3X,'RSLP=',F10.8)
C
C       28 CONTINUE
C
C -----IF THE REACH DOES NOT CONTAIN ALLUVIUM, GO ON TO NEXT REACH
C       IF (NOAL.GT.0 .OR. IRVTYP.EQ.0) GO TO 38
C
C *****
C -----CALCULATE GRADIENT OF ALLUVIUM
C *****
C
C -----GET PARAMETERS FROM RIVER LIST
C       HAL =RIVR(29,I)
C       ALNG=RIVR(32,I)
C       ASLP=RIVR(36,I)
C
C -----ASSIGN UPSTREAM PARAMETER INFORMATION
C
C       HEAD IN ALLUVIUM - UPSTREAM REACHES
C       HALUP1=RIVR(29,LUP1)
C       HALUP2=RIVR(29,LUP2)
C       HALUP3=RIVR(29,LUP3)
C       HALUP4=RIVR(29,LUP4)
C       HALUP5=RIVR(29,LUP5)
C
C       IF (HALUP1.EQ.0) LUP1=0
C       IF (HALUP2.EQ.0) LUP2=0
C       IF (HALUP3.EQ.0) LUP3=0
C       IF (HALUP4.EQ.0) LUP4=0
C       IF (HALUP5.EQ.0) LUP5=0
C
C -----LENGTH OF ALLUVIUM - UPSTREAM REACHES
C       ALNUP1=RIVR(32,LUP1)
C       ALNUP2=RIVR(32,LUP2)
C       ALNUP3=RIVR(32,LUP3)
C       ALNUP4=RIVR(32,LUP4)
C       ALNUP5=RIVR(32,LUP5)
C

```

```

C -----ASSIGN DOWNSTREAM PARAMETER INFORMATION
C -----HEAD IN ALLVIUM - DOWNSTREAM REACH
      HALDN=RIVR(29,LDN)
      IF (HALDN.EQ.0)LDN=0
C
C -----LENGTH OF ALLUVIUM - DOWNSTREAM REACH
      ALNGDN=RIVR(32,LDN)
C
C
C -----CHECK IF NO UPSTREAM OR DOWNSTREAM REACHES - GRADIENT SHOULD
      BE ENTERED IN INPUT IF THIS CONDITION EXISTS
      IF (LUP1.EQ.0 .AND. LDN.EQ.0) GO TO 38
C
C -----CHECK IF NO UPSTREAM REACHES BUT THERE IS A DOWNSTREAM REACH
      IF (LUP1.EQ.0 .AND. LDN.NE.0) GO TO 36
C
C -----CHECK FOR TWO UPSTREAM REACHES
      IF (LUP1.NE.0 .AND. LUP2.NE.0 .AND. LUP3.EQ.0) GO TO 30
C
C -----CHECK FOR THREE UPSTREAM REACHES
      IF (LUP1.NE.0 .AND. LUP2.NE.0 .AND. LUP3.NE.0 .AND. LUP4.EQ.0)
1      GO TO 31
C
C -----CHECK FOR FOUR UPSTREAM REACHES
      IF (LUP1.NE.0 .AND. LUP2.NE.0 .AND. LUP3.NE.0 .AND. LUP4.NE.0
1      .AND. LUP5.EQ.0) GO TO 32
C
C -----CHECK FOR FIVE UPSTREAM REACHES
      IF (LUP1.NE.0 .AND. LUP2.NE.0 .AND. LUP3.NE.0 .AND. LUP4.NE.0
1      .AND. LUP5.NE.0) GO TO 33
C
C -----HEAD AND LENGTH FOR ONE UPSTREAM REACH
      HAAVUP = HALUP1
      DAAVUP = ALNUP1
      GO TO 34
C
C -----CALCULATE AVG HEAD AND AVG LENGTH FOR TWO UPSTREAM REACHES
30 HAAVUP = (HALUP1+HALUP2) / 2.0
      DAAVUP = (ALNUP1+ALNUP2) / 2.0
      GO TO 34
C
C -----CALCULATE AVG HEAD AND AVG LENGTH FOR THREE UPSTREAM REACHES
31 HAAVUP = (HALUP1+HALUP2+HALUP3) / 3.0
      DAAVUP = (ALNUP1+ALNUP2+ALNUP3) / 3.0
      GO TO 34
C
C -----CALCULATE AVG HEAD AND AVG LENGTH FOR FOUR UPSTREAM REACHES
32 HAAVUP = (HALUP1+HALUP2+HALUP3+HALUP4) / 4.0
      DAAVUP = (ALNUP1+ALNUP2+ALNUP3+ALNUP4) / 4.0
      GO TO 34
C
C -----CALCULATE AVG HEAD AND AVG LENGTH FOR FIVE UPSTREAM REACHES
33 HAAVUP = (HALUP1+HALUP2+HALUP3+HALUP4+HALUP5) / 5.0
      DAAVUP = (ALNUP1+ALNUP2+ALNUP3+ALNUP4+ALNUP5) / 5.0

```

```

C
C -----CHECK IF THERE IS A DOWNSTREAM REACH
  34 IF (LDN.EQ.0) GO TO 35
C
C -----CALCULATE GRADIENT IF THERE IS AN UPSTREAM REACH(ES)
C AND A DOWNSTREAM REACH
  ASLP = (HAAVUP-HALDN) / (0.5*DAAVUP+ALNG+0.5*ALNGDN)
  GO TO 37
C
C -----CALCULATE GRADIENT IF THERE IS AN UPSTREAM REACH(ES)
C BUT NO DOWNSTREAM REACH
  35 ASLP = (HAAVUP-HAL) / (0.5*(DAAVUP+ALNG))
  GO TO 37
C
C -----CALCULATE GRADIENT IF THERE ARE NO UPSTREAM REACHES BUT
C THERE IS A DOWNSTREAM REACH
  36 ASLP = (HAL-HALDN) / (0.5*(ALNG+ALNGDN))
C
C -----IF GRADIENT OF ALLUVIUM IS CALCULATED TO BE ZERO OR NEGATIVE
C WRITE AND ERROR MESSAGE AND TERMINATE PROGRAM
  37 IF (ASLP.LE.0)WRITE(IOUT,137) I,ASLP
137 FORMAT('0 REACH #',I3,5X,'GRADIENT OF ALLUVIUM = ',F10.6/
  1 '0 GRADIENT MUST BE GREATER THAN ZERO - CHECK INPUT PARAMETERS'
  2 /'0 IF GRADIENT IS ZERO, AVERAGE HEAD IN UPSTREAM REACH OR '
  3 'HEAD IN DOWNSTREAM REACH IS EQUAL TO HEAD IN THIS REACH'/
  4 '***** PROGRAM TERMINATED')
C
C -----ABNORMAL STOP IF GRADIENT IS <= 0
  IF (ASLP.LE.0)STOP
C
C -----MAKE NEW ASSIGNMENT
  RIVR(36,I)=ASLP
  38 CONTINUE
CRIVER
C
C
*****
***
C *** BEGIN LOOP FOR BUDGET CALCULATIONS AND RIVER AND ALLUVIUM
CALCULATIONS ***
C
*****
***
C
  DO 105 L=1,NRIVER
C
C -----GET LAYER, ROW & COLUMN OF CELL CONTAINING REACH.
  IL=RIVR(1,L)
  IR=RIVR(2,L)
  IC=RIVR(3,L)
C
C6-----IF CELL IS EXTERNAL MOVE ON TO NEXT REACH.
CX  IF(IBOUND(IC,IR,IL).LE.0)GO TO 180
C

```

```

C -----GET PARAMETER FROM PROGRAM.
CX      HHNEW=HNEW(IC,IR,IL)
C
C8-----COMPARE HEAD IN AQUIFER TO BOTTOM OF RIVERBED.
C
C9-----AQUIFER HEAD > BOTTOM THEN RATE=CRIV*(HRIV-HNEW) .
CX      IF (HHNEW.GT.RBOT) RATE=CRIV*(HRIV-HHNEW)
C
C10-----AQUIFER HEAD < BOTTOM THEN RATE=CRIV*(HRIV-RBOT)
CX      IF (HHNEW.LE.RBOT) RATE=CRIV*(HRIV-RBOT)
C
CRIVER
C-----IF CELL IS EXTERNAL MOVE ON TO NEXT REACH.
        IF (IBOUND(IC,IR,IL).LE.0) GO TO 105
C
C -----GET PARAMETERS FROM PROGRAM
        HHNEW=HNEW(IC,IR,IL)
C
C7-----GET PARAMETERS FROM RIVER LIST.
CX      HRIV =RIVR(4,L)
CX      CRIV =RIVR(5,L)
CX      RBOT =RIVR(6,L)
C
CRIVER
        LDN   =RIVR(4,L)
        LUP1  =RIVR(5,L)
        LUP2  =RIVR(6,L)
        LUP3  =RIVR(7,L)
        LUP4  =RIVR(8,L)
        LUP5  =RIVR(9,L)
        NOAL  =RIVR(10,L)
        HRIV  =RIVR(11,L)
        RBOT  =RIVR(12,L)
        BWID  =RIVR(13,L)
        SIDE  =RIVR(14,L)
        AN    =RIVR(15,L)
        RLNG  =RIVR(16,L)
        SHY   =RIVR(17,L)
        THS   =RIVR(18,L)
        SGHY  =RIVR(19,L)
        THSG  =RIVR(20,L)
        HNEG  =RIVR(21,L)
        RSLP  =RIVR(22,L)
        RSPDST=RIVR(23,L)
        QRDVR =RIVR(24,L)
        QRRF  =RIVR(25,L)
        RPRCP=RIVR(26,L)
        REVAP=RIVR(27,L)
        QRO   =RIVR(28,L)
        QR    =RIVR(43,L)
        RIVBOT=RIVR(45,L)
        CRIV  =RIVR(47,L)
        BHY   =RIVR(48,L)
        BBOT  =RIVR(49,L)

```



```

C
C -----GET ALLUVIUM PARAMETER INFORMATION
  55 HAL    =RIVR(29,L)
      ABOT  =RIVR(30,L)
      WIDA  =RIVR(31,L)
      ALNG  =RIVR(32,L)
      AHY   =RIVR(33,L)
      SYA   =RIVR(34,L)
      ASPDST=RIVR(35,L)
      ASLP  =RIVR(36,L)
      RCHAL =RIVR(37,L)
      EVTRAL=RIVR(38,L)
      SURFAL=RIVR(39,L)
      EXELAL=RIVR(40,L)
      QAPMP =RIVR(41,L)
      CAL   =RIVR(46,L)

C
C -----HEAD IN ALLUVIUM IN UPSTREAM REACH
      HALUP1=RIVR(29,LUP1)
      HALUP2=RIVR(29,LUP2)
      HALUP3=RIVR(29,LUP3)
      HALUP4=RIVR(29,LUP4)
      HALUP5=RIVR(29,LUP5)

C
C -----BOTTOM OF ALLUVIUM IN UPSTREAM REACH
      ABTUP1=RIVR(30,LUP1)
      ABTUP2=RIVR(30,LUP2)
      ABTUP3=RIVR(30,LUP3)
      ABTUP4=RIVR(30,LUP4)
      ABTUP5=RIVR(30,LUP5)

C
C -----LENGTH OF ALLUVIUM IN UPSTREAM REACH
      ALNUP1=RIVR(32,LUP1)
      ALNUP2=RIVR(32,LUP2)
      ALNUP3=RIVR(32,LUP3)
      ALNUP4=RIVR(32,LUP4)
      ALNUP5=RIVR(32,LUP5)

C
C -----WIDTH OF ALLVIUM IN UPSTREAM REACH
      WDAUP1=RIVR(31,LUP1)
      WDAUP2=RIVR(31,LUP2)
      WDAUP3=RIVR(31,LUP3)
      WDAUP4=RIVR(31,LUP4)
      WDAUP5=RIVR(31,LUP5)

C

```

```

C -----HYDRAULIC CONDUCTIVITY OF ALLUVIUM IN UPSTREAM REACH
  AHYUP1=RIVR(33,LUP1)
  AHYUP2=RIVR(33,LUP2)
  AHYUP3=RIVR(33,LUP3)
  AHYUP4=RIVR(33,LUP4)
  AHYUP5=RIVR(33,LUP5)

C
C -----GRADIENT OF ALLUVIUM IN UPSTREAM REACH
  ASLUP1=RIVR(36,LUP1)
  ASLUP2=RIVR(36,LUP2)
  ASLUP3=RIVR(36,LUP3)
  ASLUP4=RIVR(36,LUP4)
  ASLUP5=RIVR(36,LUP5)

C
C -----LENGTH AND HYDRAULIC CONDUCTIVITY OF DOWNSTREAM REACH
  ALNGDN=RIVR(32,LDN)
  AHYDN =RIVR(33,LDN)

C
C -----SET FLAGS TO INDICATE IF UPSTREAM OR DOWNSTREAM REACH INCLUDES
ALLUVIUM
C     IF KLUP1 = 1, THERE IS ONE UPSTREAM REACH THAT INCLUDES ALLUVIUM
C     IF KLUP2 = 1, THERE ARE TWO UPSTREAM REACHES THAT INCLUDES ALLUVIUM
C     ALSO FOR KLUP3 THROUGH KLUP5
C     IF KLDN = 1, THERE IS A DOWNSTREAM REACH THAT INCLUDES ALLUVIUM
C -----INITIALIZE VALUES
  KLUP1=0
  KLUP2=0
  KLUP3=0
  KLUP4=0
  KLUP5=0
  KLDN=0

C
C -----CHECK IF THERE IS A VALUE FOR NOAL IN UPSTREAM AND DOWNSTREAM
REACHES
  JLUP1=RIVR(10,LUP1)
  JLUP2=RIVR(10,LUP2)
  JLUP3=RIVR(10,LUP3)
  JLUP4=RIVR(10,LUP4)
  JLUP5=RIVR(10,LUP5)
  JLDN =RIVR(10,LDN)

C
C -----CHECK IF THERE IS AN UP OR DOWSTREAM REACH(ES) AND IF IT INCLUDES
ALLUV.
  IF(LUP1.NE.0 .AND. JLUP1.EQ.0) KLUP1=1
  IF(LUP2.NE.0 .AND. JLUP2.EQ.0) KLUP2=1
  IF(LUP3.NE.0 .AND. JLUP3.EQ.0) KLUP3=1
  IF(LUP4.NE.0 .AND. JLUP4.EQ.0) KLUP4=1
  IF(LUP5.NE.0 .AND. JLUP5.EQ.0) KLUP5=1
  IF(LDN .NE.0 .AND. JLDN .EQ.0) KLDN =1

C

```

```

C
*****
***
C           ***** BEDROCK - ALLUVIUM SEEPAGE *****
C
*****
***
C -----SIGN CONVENTION  QAB IS + FOR GAINING BEDROCK
C
C -----CHECK IF HEAD IN BEDROCK AQUIFER IS BELOW BOTTOM OF ALLUVIUM
C   56 IF(HHNEW .LT. ABOT) GO TO 60
C
C -----CALCULATE SEEPAGE - SATURATED CONDITIONS - HHNEW > ABOT
C   QAB=CAL*(HAL-HHNEW)
C   GO TO 65
C
C -----CALCULATE SEEPAGE - UNSATURATED CONDITIONS - HHNEW < ABOT
C   IF ALLUVIUM IS DRY, HAL=ABOT, AND QAB=0.0
C   60 QAB=CAL*(HAL-ABOT)
C
C   65 CONTINUE
C
C -----RATE IS THE ALLUVIUM/BEDROCK SEEPAGE
C   QAB IS + IF GROUNDWATER AQUIFER GAINS
C   WRITE(IOUT, 855) L,CAL,QAB
C   855 FORMAT('L=',I3,3X,'CAL=',G15.7,3X,'QAB=',G15.7)
C   RATE=QAB
C   WRITE(IOUT,856)RATE
C   856 FORMAT('RATE=',G15.7)
C   CONTINUE
C
C
*****
***
C           ***** SEEPAGE BETWEEN RIVER AND ALLUVIUM *****
C
*****
***
C -----SIGN CONVENTION -- QRA IS + IF ALLUVIUM IS GAINING
C
C -----TEST FOR GAINING RIVER
C   IF (HAL.GT.HRIV) GO TO 73
C
C -----CALCULATE TRUE RIVER BOTTOM FOR LOSING RIVER
C   RIVBOT = RBOT + THS
C
C -----TEST FOR DRY RIVER AND HEAD IN ALLUVIUM BELOW RIVER BOTTOM
C   IF (HRIV.LE.RIVBOT .AND. HAL.LE.RIVBOT) GO TO 76
C
C -----TEST FOR LOSING RIVER - NO HYDRAULIC CONNECTION
C   IF (HAL.LT.RIVBOT) GO TO 71
C

```



```

C *****
C -----LOSING RIVER - HYDRAULICALLY CONNECTED
C *****
C
C -----CHECK IF SILT LAYER IS PRESENT
C       IF (SHY.EQ.0.0) GO TO 70
C
C -----CALCULATE EQUIVALENT HYDRAULIC CONDUCTIVITY IF SILT LAYER PRESENT
C       EQUIVK = (RIVBOT-ABOT) / (THS/SHY + (RBOT-ABOT)/AHY)
C
C -----CALCULATE SEEPAGE VELOCITY - SATURATED CONDITIONS WITH SILT LAYER
C       SVS = EQUIVK * (HRIV-HAL) / (0.5*(RBOT-ABOT)+THS)
C
C -----CALCULATE FLUX FROM RIVER TO ALLUVIUM
C       QRA = SVS * (BWID+(2.0*(HRIV-RIVBOT)/SIDE)) * RLNG
C       GO TO 77
C
C -----CALCULATE SEEPAGE BETWEEN RIVER AND ALLUVIUM IF NO SILT LAYER IS
C PRESENT
C       70 QRA=AHY * (HRIV-HAL) / (0.5*(RIVBOT-ABOT)) *
C         1 (BWID+(2.0*(HRIV-RIVBOT)/SIDE)) * RLNG
C         GO TO 77
C
C *****
C -----LOSING RIVER - NO HYDRAULIC CONNECTION
C *****
C
C -----CHECK IF SILT LAYER IS PRESENT
C       71 IF(SHY.EQ.0.0) GO TO 72
C
C -----CALCULATE SEEPAGE VELOCITY - UNSATURATED CONDITONS - SILT LAYER
C PRESENT
C       SVU = SHY * (HRIV-RIVBOT+HNEG) / THS
C
C -----CALCULATE SEEPAGE FROM RIVER TO ALLUVIUM
C       QRA = SVU * (BWID+(2.0*(HRIV-RIVBOT)/SIDE)) * RLNG
C       GO TO 77
C
C -----CALCULATE SEEPAGE VELOCITY - UNSAT. COND. - NO SILT LAYER
C       USE HY. COND. OF ALLUVIUM AND GRADIENT = 1.0
C       72 QRA = AHY * (BWID+(2.0*(HRIV-RIVBOT)/SIDE)) *RLNG
C       GO TO 77
C *****
C -----GAINING RIVER
C *****
C
C -----CALCULATE TRUE RIVER BOTTOM FOR GAINING RIVER
C       73 RIVBOT= RBOT + THSG
C
C -----IF SILT GAIN. HY. COND. NOT SPECIFIED, ASSUME NO SILT LAYER
C       IS PRESENT WHEN CALCULATING RIVER SEEPAGE
C       IF(SGHY.EQ.0.0) GO TO 75
C
C -----THE FOLLOWING SEEPAGE CALCULATIONS INVOLVE A SILT LAYER

```

```

C
C -----CALCULATE EQUIVALENT HYDRAULIC CONDUCTIVITY
      SAEQVK = (RIVBOT-ABOT) / (THSG/SGHY + (RBOT-ABOT)/AHY)
C
C -----CALCULATE SEEPAGE FROM RIVER TO ALLUVIUM
      QRA = SAEQVK * (HRIV-HAL) / (0.5*(RBOT-ABOT)+THSG)
      1      * (BWID+(2.0*(HRIV-RIVBOT)/SIDE)) * RLNG
      GO TO 77
C
C -----THE FOLLOWING SEEPAGE CALCULATIONS ASSUME NO SILT LAYER PRESENT
C
C -----CALCULATE RIVER SEEPAGE - GAINING RIVER - SATURATED CONDITIONS
C      NO SILT LAYER
      75 QRA = AHY * (HRIV-HAL) / (0.5*(RIVBOT-ABOT))
      1      * (BWID+(2.0*(HRIV-RIVBOT)/SIDE)) * RLNG
      GO TO 77
C
C -----NO SEEPAGE - RIVER IS DRY AND HEAD IN ALLUVIUM IS BELOW RIVER
BOTTOM
      76 QRA = 0.0
      77 CONTINUE
C
C
C *****
C ***** MASS BALANCE OF RIVER FLOW *****
C *****
C *****
C
C -----SET QRUP ACCUMULATOR TO ZERO
      80 QRUP = 0.0
      QRUP1= 0.0
      QRUP2= 0.0
      QRUP3= 0.0
      QRUP4= 0.0
      QRUP5= 0.0
C
C -----IF THERE IS NO UPSTREAM REACH SKIP OVER THIS CALCULATION
C      FOR FLOW FROM THE UPSTREAM REACH(ES)
      IF (LUP1.EQ.0) GO TO 81
C
C -----ASSIGN RIVER DISCHARGE VALUES FOR UPSTREAM REACHES
      QRUP1=RIVR(43,LUP1)
      QRUP2=RIVR(43,LUP2)
      QRUP3=RIVR(43,LUP3)
      QRUP4=RIVR(43,LUP4)
      QRUP5=RIVR(43,LUP5)
C

```

```

C -----CALCULATE FLOW COMING IN FROM UPSTREAM REACH(ES)
  QRUP = QRUP1
  IF (LUP2.NE.0) QRUP = QRUP + QRUP2
  IF (LUP3.NE.0) QRUP = QRUP + QRUP3
  IF (LUP4.NE.0) QRUP = QRUP + QRUP4
  IF (LUP5.NE.0) QRUP = QRUP + QRUP5
C
C -----CHECK IF REACH INCLUDES ALLUVIUM
  81 IF (IRVTYP.NE.0 .AND. NOAL.LE.0) GO TO 82
C
C -----CALCULATE RATE OF PRECIPITATION FALLING ON REACH
  QRPRCP=RPRCP*RLNG* (BWID+(2.0*(HRIV-RIVBOT)/SIDE))
C
C -----CALCULATE RATE OF EVAPORATION OUT OF REACH
  QREVAP=REVAP*RLNG*(BWID+(2.0*(HRIV-RIVBOT)/SIDE))
C
C -----CALCULATE DISCHARGE IN RIVER REACH FOR REACH WITHOUT ALLUVIUM
  (CMS IS METRIC, CFS IF ENGLISH)
  QR = QRUP - (QRB/SEC) + QRDVR + QRRF + QRPRCP
  1   + QREVAP + QRO
  GO TO 83
C
C -----CALCULATE DISCHARGE IN RIVER REACH FOR REACH WITH ALLUVIUM
  (CMS IS METRIC, CFS IF ENGLISH)
  82 QR = QRUP - (QRA/SEC) + QRDVR + QRRF + QRPRCP
  1   + QREVAP + QRO
C
C -----CHECK FOR A NEGATIVE VALUE FOR RIVER FLOW AND IF NEG PRINT WARNING
  83 IF (QR.LT.0.0) WRITE(IOUT,84) L,QR
  84 FORMAT(25X,'***** WARNING! *****/'REACH #',I3,5X,
  1       'NEGATIVE RIVER FLOW (CFS OR CMS) = ',G15.5,5X,
  2       'RIVER FLOW WILL BE SET TO ZERO'/)
C
C -----IF RIVER FLOW IS NEGATIVE, MAKE IT EQUAL 0
  IF (QR.LT.0.0) QR=0.0
C
C -----MAKE NEW ASSIGNMENT
  RIVR(43,L)=QR
  CONTINUE
C
C
*****
***
C           ***** RIVER DEPTH CALCULATION - ITERATION LOOP *****
C
*****
***
C
C -----IF RIVER FLOW IS EQAUL TO ZERO, SKIP DEPTH CALCULATION
  IF (QR.EQ.0.0) GO TO 89
C
C -----SET TOLERANCE FOR LOOP
  QHI = (1+DTOLD) * QR
  QLO = (1-DTOLD) * QR

```

```

C
C -----BEGIN ITERATION LOOP - SET COUNTER
      NEWD = 1
C
C -----USE SIMPLIFIED MANNING EQUATION TO ESTIMATE NEW DEPTH
      D = ((QR*AN) / (C*BWID*(SQRT(RSLP)))) ** 0.6
C
C -----CALCULATE CROSS-SECTIONAL AREA OF (TRAPEZOIDAL) CHANNEL
      85 XA = (BWID*D) + ((D**2.0)/SIDE)
C
C -----CALCULATE WETTED PERIMETER
      P = BWID + (2.0*D*SQRT(1.0+(1.0/(SIDE**2.0))))
C
C -----CALCULATE ESTIMATED QR USING MANNING EQUATION (TRAPEZOIDAL
CHANNEL)
      QREST = C / AN * XA * ((XA/P)**(2.0/3.0)) * SQRT(RSLP)
C
C -----CHECK IF FLOW IS WITHIN TOLERANCE
      IF (QREST.LE.QHI .AND. QREST.GE.QLO) GO TO 90
C
C -----INCREMENT COUNTER
      NEWD = NEWD+1
C
C -----CHECK IF MAXIMUM NUMBER OF ITERATIONS IS REACHED
      IF(NEWD.GE.ITRD) GO TO 86
C
C -----IF ESTIMATED FLOW IS TOO HIGH, INCREASE DEPTH BY TOLERANCE VALUE
      IF (QREST.GT.QHI) D = D * (1-DTOLD)
C
C -----IF ESTIMATED FLOW IS TOO LOW, DECREASE DEPTH BY TOLERANCE VALUE
      IF (QREST.LT.QLO) D = D * (1+DTOLD)
C
C -----RETURN FOR ANOTHER ITERATION
      GO TO 85
C
C -----IF MAX # OF ITERATIONS REACHED AND DEPTH DID NOT CONVERGE, PRINT
WARNING
      86 ERROR = DTOLD * 100.0
        WRITE(IOUT, 87) L, ITRD, QR, QREST, ERROR, D
      87 FORMAT(25X, '***** WARNING! *****'/'REACH #', I3,
1         ' CALCULATION OF RIVER DEPTH FAILED TO CONVERGE AFTER ', I3,
2         ' ITERATIONS'/'RIVER FLOW = ', G12.5, 5X, 'FINAL ESTIMATE = ',
3         G12.5/'YOU HAVE SPECIFIED THE DEPTH SHOULD BE WITHIN ',
4         F5.2, '% ERROR'/'DEPTH IS CURRENTLY ', G10.4, ' AND WILL BE',
5         ' USED IN SUBSEQUENT CALCULATIONS')
      88 GO TO 90
C
C -----IF RIVER FLOW IS EQUAL TO 0.0, RIVER DEPTH IS EQUAL TO 0.0
      89 D=0.0
C
C -----CALCULATE NEW RIVER STAGE
      90 HRIV = RIVBOT + D
C

```

```

C -----MAKE NEW ASSIGNMENT
      RIVR(11,L)=HRIV
C
C -----IF NO ALLUVIUM IN REACH, SKIP OVER NEXT SECTION
      IF (NOAL.GT.0 .OR. IRVTYP.EQ.0) GO TO 101
C
C
*****
***
C           ***** MASS BALANCE OF FLOW IN ALLUVIUM *****
C
*****
***
C
C *****
C -----CALCULATE THE FLUX INTO OR OUT OF REACH L
C           FROM UPSTREAM AND DOWNSTREAM REACHES
C *****
C
C -----SET ACCUMULATORS TO ZERO
      QAUP = 0.0
      QAUP1 = 0.0
      QAUP2 = 0.0
      QAUP3 = 0.0
      QAUP4 = 0.0
      QAUP5 = 0.0
C
C -----CHECK IF THERE ARE NO UPSTREAM AND DOWNSTREAM REACHES FOR REACH L
      IF (KLUP1.EQ.0 .AND. KLDN.EQ.0) GO TO 95
C
C -----CHECK IF THERE IS A DOWNSTREAM REACH BUT NO UPSTREAM REACH
      IF (KLUP1.EQ.0 .AND. KLDN.NE.0) GO TO 92
C
C -----CALCULATE QAUP FOR ONE UPSTREAM REACH WITH ALLUVIUM
C           USE WEIGHTED HARMONIC MEAN FOR EQUIVALENT HYDRAULIC
C           CONDUCTIVITY BETWEEN TWO REACHES FOR QAUP1 THRU QAUP5 CALCULATIONS
      QAUP1 = (ALNUP1+ALNG) / (ALNUP1/AHYUP1 + ALNG/AHY) * ASLUP1
1          * (HALUP1-ABTUP1) * WDAUP1
C
C -----CHECK FOR TWO UPSTREAM REACHES WITH ALLUVIUM
      IF (KLUP2.EQ.0) GO TO 91
C
C -----CALCULATE QAUP FOR SECOND UPSTREAM REACH
      QAUP2 = (ALNUP2+ALNG) / (ALNUP2/AHYUP2 + ALNG/AHY) * ASLUP2
1          * (HALUP2-ABTUP2) * WDAUP2
C
C -----CHECK FOR THREE UPSTREAM REACHES WITH ALLUVIUM
      IF (KLUP3.EQ.0) GO TO 91
C
C -----CALCULATE QAUP FOR THIRD UPSTREAM REACH
      QAUP3 = (ALNUP3+ALNG)/(ALNUP3/AHYUP3 + ALNG/AHY) * ASLUP3
1          * (HALUP3-ABTUP3) * WDAUP3

```

```

C
C -----CHECK FOR FOUR UPSTREAM REACHES WITH ALLUVIUM
      IF (KLUP4.EQ.0) GO TO 91
C
C -----CALCULATE QAUP FOR FOURTH UPSTREAM REACH
      QAUP4 = (ALNUP4+ALNG)/(ALNUP4/AHYUP4 + ALNG/AHY) * ASLUP4
      1      * (HALUP4-ABTUP4) * WDAUP4
C
C -----CHECK FOR FIVE UPSTREAM REACHES WITH ALLUVIUM
      IF (KLUP5.EQ.0) GO TO 91
C
C -----CALCULATE QAUP FOR FIFTH UPSTREAM REACH
      QAUP5 = (ALNUP5+ALNG) / (ALNUP5/AHYUP5 + ALNG/AHY) * ASLUP5
      1      * (HALUP5-ABTUP5) * WDAUP5
C
C -----ACCUMULATE ALL FLUXES INTO REACH L FROM UPSTREAM REACHES
      91 QAUP = QAUP1 + QAUP2 + QAUP3 + QAUP4 + QAUP5
      GO TO 93
C
C -----IF THERE IS NO UPSTREAM REACH CALCULATE FLUX ENTERING REACH L
      92 QAUP = AHY * ASLP * (HAL-ABOT) * WIDA
C
C -----CHECK IF THERE IS NO DOWNSTREAM REACH
      93 IF (KLDN.EQ.0) GO TO 94
C
C -----CALCULATE FLUX FROM REACH L INTO DOWNSTREAM REACH
      QADN = (ALNGDN+ALNG) / (ALNGDN/AHYDN + ALNG/AHY) * ASLP
      1      * (HAL-ABOT) * WIDA
      GO TO 96
C
C -----IF THERE IS NO DOWNSTREAM REACH, CALCULATE FLUX LEAVING REACH L
      94 QADN = AHY * ASLP * (HAL-ABOT) * WIDA
      GO TO 96
C
C -----IF THERE IS NO UPSTREAM OR DOWNSTREAM REACH QAUP=QADN=0.0
      95 QAUP = 0.0
      QADN = 0.0
C
C -----MAKE NEW ASSIGNMENT
      96 RIVR(42,L)=QADN
      CONTINUE
C
C *****
C -----CALCULATE RECHARGE INTO ALLUVIUM
C *****
      QARCH = 0.0
      QARCH = RCHAL * ALNG * WIDA

```

```

C
C *****
C -----CALCULATE EVAPOTRANSPIRATION IN ALLUVIUM
C *****
C
C*****MUST BYPASS THIS IF ZEROS ARE ENTERED*****
C
C      QAET = 0.0
C
C -----CHECK IF HEAD IN ALLUVIUM IS ABOVE ET SURFACE ELEVATION
C      IF (HAL.GE.SURFAL) GO TO 97
C
C -----CHECK IF HEAD IN ALLUVIUM IS BELOW ET EXTINCTION ELEVATION
C      IF(HAL.LE.EXELAL) GO TO 98
C
C -----CALCULATE ET
C      QAET=EVTRAL * (HAL-EXELAL) / (SURFAL-EXELAL)
C      GO TO 99
C
C -----IF HEAD IN ALLUVIUM IS ABOVE ET SURFACE ELEVATION ET = MAX ET
RATE
C      97 QAET = EVTRAL
C      GO TO 99
C
C -----IF HEAD IN ALLUVIUM IS BELOW ET EXTINCTION ELEVATION ET = 0
C      98 QAET=0.0
C
C -----IF ALLUVIUM IS DRY, SET QAPMP EQUAL TO 0
C      IF(HAL.EQ.ABOT)QAPMP=0.0
C
C -----CALCULATE DELTA FLUX IN ALLUVIAL REACH
C      99 DQA = QRA - QAB + QAUP - QADN + QARCH + QAET + QAPMP
C
C
C *****
C ***** CALCULATE NEW HEAD IN ALLUVIUM *****
C *****
C
C -----CALCULATE CHANGE IN HEAD IN ALLUVIUM
C      DHAL = SYA * DQA * DELT / (WIDA*ALNG)
C
C -----CALCULATE NEW HEAD IN ALLUVIUM
C      HALNEW = DHAL + HAL
C
C ----- IF HALNEW IS LESS THAN ABOT, WRITE ERROR MESSAGE
C      IF (HALNEW.LT.ABOT) WRITE(IOUT,100) L,HALNEW,ABOT
100 FORMAT(25X,' ***** WARNING! *****'/'REACH #',I3,5X,
1      'HEAD IN ALLUVIUM IS LOWER THAN BOTTOM OF ALLUVIUM'/
2      'HEAD IN ALLUVIUM = ',F15.9,5X,'BOTTOM ELEVATION = ',F10.4,
3      '/ALLUVIUM IS DRY -- HEAD IN ALLUVIUM IS SET EQUAL TO ',
4      'BOTTOM ELEVATION OF ALLUVIUM'/)

```

```

C
C -----IF HEAD IN ALLUVIUM IS LESS THAN BOTTOM ELEV SET IT EQUAL TO ABOT
      IF (HALNEW.LT.ABOT) HALNEW = ABOT
C
C -----MAKE NEW ASSIGNMENT
      RIVR(44,L)=HALNEW
      CONTINUE
CRIVER
C
*****
***
C ***** PRINT INDIVIDUAL RATES OR SAVE C-B-C FLOW TERMS AS REQUESTED
*****
C
*****
***
CX
CX11-----PRINT THE INDIVIDUAL RATES IF REQUESTED(IRIVCB<0).
CX      IF(IRIVCB.LT.0.AND.ICBCFL.NE.0) WRITE(IOUT,900) (TEXT(N),N=1,4),
CX      1      KPER,KSTP,L,IL,IR,IC,RATE
CX900 FORMAT(1H0,4A4,' PERIOD',I3,' STEP',I3,' REACH',I4,
CX      1      ' LAYER',I3,' ROW',I4,' COL',I4,' RATE',G15.7)
CX
CX12-----IF C-B-C FLOW TERMS ARE TO BE SAVED THEN ADD RATE TO BUFFER.
CX      IF(IBD.EQ.1) BUFF(IC,IR,IL)=BUFF(IC,IR,IL)+RATE
CX
CX13-----SEE IF FLOW IS INTO AQUIFER OR INTO RIVER.
CX      IF(RATE)94,100,96
CX
CX14-----AQUIFER IS DISCHARGING TO RIVER SUBTRACT RATE FROM RATOUT.
CX 94 RATOUT=RATOUT-RATE
CX      GO TO 100
CX
CX15-----AQUIFER IS RECHARGED FROM RIVER ADD RATE TO RATIN.
CX 96 RATIN=RATIN+RATE
CX
CRIVER
C
C -----PRINT THE INDIVIDUAL RATES IF REQUESTED(IRIVCB<0).
C ***** THIS IS FOR REACH WITH ALLUVIUM *****
C      IF(IRIVCB.LT.0.AND.ICBCFL.NE.0) WRITE(IOUT,900)
      1      KPER,KSTP,L,IL,IR,IC,HALNEW,RATE
900 FORMAT(1H0,'ALLUVIUM LEAKAGE',
      1      ' PERIOD',I3,' STEP',I3,' REACH',I4,
      2      ' LAYER',I3,' ROW',I4,' COL',I4,' HEAD',G12.4,
      3      ' RATE',G15.7)
      IF(IRIVCB.LT.0.AND.ICBCFL.NE.0) WRITE(IOUT,901) QR,HRIV,QRA
901 FORMAT(1H0,' RIVER/ALLUVIUM LEAKAGE',30X,'RIVER DISCHARGE',
      1      G15.7,' STAGE',G12.4,' RATE',G15.7)
C
C -----SINCE REACH CONTAINS ALLUVIUM, JUMP OVER THIS PRINTOUT SECTION
      GO TO 102
C

```



```

C -----PRINT THE INDIVIDUAL RATES IF REQUESTED(IRIVCB<0).
C ***** THIS IS FOR REACH WITHOUT ALLUVIUM *****
101 IF(IRIVCB.LT.0.AND.ICBCFL.NE.0) WRITE(IOUT,904) (TEXT(N),N=1,4),
1 KPER,KSTP,L,IL,IR,IC,QR,HRIV,RATE
904 FORMAT(1H0,4A4,' PERIOD',I3,' STEP',I3,' REACH',I3,
1 ' LAYER',I3,' ROW',I3,' COL',I3,' Q ',G10.5,
2 ' STAGE ',F7.2,' RATE',G14.6)
C IF(IRIVCB.LT.0.AND.ICBCFL.NE.0) WRITE(IOUT,905)
905 FORMAT(1H0,57X,'RIVER DISCHARGE',G15.7)
C
C -----IF C-B-C FLOW TERMS ARE TO BE SAVED THEN ADD RATE TO BUFFER.
C THIS APPLIES TO REACHES WITH OR WITHOUT ALLUVIUM
102 IF(IBD.EQ.1) BUFF(IC,IR,IL)=BUFF(IC,IR,IL)+RATE
C
C -----SEE IF FLOW IS INTO GROUNDWATER AQUIFER OR INTO ALLUVIUM OR RIVER
C IF(RATE)103,105,104
C
C -----AQUIFER IS DISCHARGING TO ALLUVIUM OR RIVER - SUBTRACT RATE FROM
RATOUT
103 RATOUT=RATOUT-RATE
GO TO 105
C
C -----AQUIFER IS RECHARGED FROM ALLUVIUM OR RIVER - ADD RATE TO RATIN.
104 RATIN=RATIN+RATE
105 CONTINUE
C
C *****
***
C ***** LOOP TO MAKE HALNEW = HAL FOR NEXT TIME STEP *****
C *****
***
DO 110 J=1,NRIVER
RIVR(29,J)=RIVR(44,J)
110 CONTINUE
CRIVER
C *****
***
C ***** MOVES RATES, VOLUMES & LABELS INTO ARRAYS FOR PRINTING
*****
C *****
***
C
C16-----IF C-B-C FLOW TERMS WILL BE SAVED CALL UBUDSV TO RECORD THEM.
IF(IBD.EQ.1) CALL UBUDSV(KSTP,KPER,TEXT,IRIVCB,BUFF,NCOL,NROW,
1 NLAY,IOUT)
C

```

C17-----MOVE RATES,VOLUMES & LABELS INTO ARRAYS FOR PRINTING.

```
115 VBVL(3,MSUM)=RATIN
    VBVL(4,MSUM)=RATOUT
    VBVL(1,MSUM)=VBVL(1,MSUM)+RATIN*DELT
    VBVL(2,MSUM)=VBVL(2,MSUM)+RATOUT*DELT
    VBNM(1,MSUM)=TEXT(1)
    VBNM(2,MSUM)=TEXT(2)
    VBNM(3,MSUM)=TEXT(3)
    VBNM(4,MSUM)=TEXT(4)
```

C

C18-----INCREMENT BUDGET TERM COUNTER

```
MSUM=MSUM+1
```

C

C19-----RETURN

```
RETURN
CLOSE(UNIT=8)
END
```

APPENDIX C

INSTRUCTIONS FOR RUNNING DENVER BASIN FILES

Description of Data Files

The following procedures must be followed to complete computer runs:

1. Run steady state simulation to obtain reasonable input head for "transient" run that will yield a true equilibrium situation. This steady state run will not yield reasonable flows in rivers or alluvium because the explicit alluvium is not set up for a direct steady state simulation. This will impact results throughout the model, not just in areas with explicit alluvium. This run must be conducted before the others or instabilities will result.

The following files are used in the steady state run:

MODFLOW package	Unit number	File name
Output	06	YOUNAME.OUT
Basic	01	BASIC.SS
Block Centered Flow	11	BCFLOW.SS
River	14	RIVER.DAT
Recharge	18	RECHARGE.DAT
Strongly Implicit Procedure	19	SIP
Output Control	22	OC

2. Run 100 year transient simulation with no stresses to the system to obtain an initial equilibrium condition. This run will calculate heads in the explicit alluvium and resulting stream flows at steady state. Two stress periods are simulated. The first stress period is approximately 30 days and starts with a one day time step and increases each time step by 1.2 up to a six day time step using the TMULT parameter in the basic package. The second stress period is 100 years with each time step 30 days long for a total of 1200 time steps.

The following files are used in the 100 year run:

MODFLOW package	Unit number	File name
Output	06	YOUNAME.OUT
Basic	01	BAS100.SS
Block Centered Flow	11	BCFLOW.TRN
River	14	RIVER.DAT
Recharge	18	RECHARGE.DAT
Strongly Implicit Procedure	19	SIP.TRN
Output Control	22	100OC

3. Run 40 year transient simulation with pumping. The lower pumping rates are simulated in the first two stress periods and pumping rate is increased in the third stress period and remains at that rate for the last stress period. The first stress period lasts approximately 30 days and starts with a one day time step and increases by increasing each time step by 1.2 to a time step of 6 days using the TMULT parameter in the basic package. The second stress period lasts approximately 20 years with each time step 30 days long for a total of 250 time steps. The third stress period is simulated the same as the first with the pumping rates increased, and the fourth stress period is simulated the same way as the second stress period using the same pumping rates as in the third stress period. The following files are used in the 40 year run:

MODFLOW package	Unit number	File name
Output	06	YOUNAME.OUT
Basic	01	BAS40.TRN
Block Centered Flow	11	BCFLOW.TRN
Well	12	WELL.DAT
River	14	RIVER.DAT
Recharge	18	RECHARGE.DAT
Strongly Implicit Procedure	19	SIP.TRN
Output Control	22	40OC