

**PLANNING WATER REUSE:  
DEVELOPMENT OF REUSE THEORY  
AND THE INPUT-OUTPUT MODEL  
VOL. II: APPLICATION**

by

**Darrel Klooz  
David W. Hendricks**

**September 1980**

**COLORADO WATER RESOURCES**



**RESEARCH INSTITUTE**

**Colorado State University  
Fort Collins, Colorado**

**Completion Report No. 115**

Planning Water Reuse--Development of Reuse Theory  
and the Input-Output Model

Volume II: Application of the Input-Output Water Balance Model

Completion Report  
OWRT Project No. 78-270450-145

by

Darrel Klooz  
David W. Hendricks

Department of Civil Engineering  
Colorado State University

submitted to

Office of Water Research and Technology  
U.S. Department of the Interior  
Washington, D.C. 20240

September 1980

The work upon which this report is based was supported (in part) by funds provided by the United States Department of the Interior, Office of Water Research and Technology, as authorized by the Water Resources Research Act of 1978.

Contents of this publication do not necessarily reflect the views and policies of the Office of Water Research and Technology, U.S. Department of the Interior, nor does mention of trade names or commercial products constitute their endorsement or recommendation for use by the U.S. government.

Colorado Water Resources Research Institute  
Colorado State University  
Fort Collins, Colorado  
Norman A. Evans, Director



TABLE OF CONTENTS

<u>Chapter</u>		<u>Page</u>
I	INTRODUCTION . . . . .	1
	1.1 Purpose of Investigation and Project Goals . . .	1
	1.2 Approach . . . . .	2
II	REVIEW OF THE INPUT-OUTPUT PRINCIPLES AND THE CONCEPT OF WATER REUSE . . . . .	3
	2.1 Principles of Input-Output Modeling . . . . .	3
	2.2 Water Reuse . . . . .	8
	2.2.1 Reuse Definitions . . . . .	8
	2.2.2 Reuse Line Diagrams . . . . .	12
	2.2.3 The Mechanics of Development "New" Water by Water Reuse . . . . .	14
	2.2.4 Water Reuse in Existing Applications of the Input-Output Model . . . . .	18
	2.3 Why Input-Output Modeling for Reuse Analysis? . .	21
III	ADAPTION OF THE INPUT-OUTPUT MODEL TO WATER REUSE SYSTEMS . . . . .	26
	3.1 Methodology . . . . .	26
	3.1.1 Scheme I . . . . .	32
	3.1.2 Scheme II . . . . .	35
	3.1.3 Summary of the Methodology . . . . .	35
	3.2 Data Requirements . . . . .	38
IV	THE CACHE LA POUFRE RIVER REUSE MODEL . . . . .	43
	4.1 The Area of Investigation . . . . .	43
	4.2 Fundamental Model Assumptions . . . . .	51
	4.3 The Elements of the Models . . . . .	53
	4.3.1 Entry Components . . . . .	53
	4.3.2 Internal Components, Use Systems . . . . .	55
	4.3.3 Exit Components . . . . .	59
	4.3.4 Return Flow Components . . . . .	60
	4.4 The 1979 Reuse Models . . . . .	60
	4.4.1 The 1979 Reuse Model - Scheme I . . . . .	60
	4.4.2 The 1979 Reuse Model - Scheme II . . . . .	63

"No higher quality water, unless there is a surplus of it, should be used for a purpose that can tolerate a lower grade."

UN Economic and Social Council  
1958

LIST OF TABLES

<u>Table</u>		<u>Page</u>
3-1	Data Requirement for the Input-Output Model of the Cache la Poudre River Basin Water System . . . . .	41
4-1	Projected Water Demands of the Municipal Sector for the Year 2020 . . . . .	67
4-2	Projected Water Demands of the Industrial Sector for the Year 2020 . . . . .	69
4-3	Project Water Demands of the Agricultural Sector for the Year 2020 . . . . .	70
4-4	Projected Water Inputs into the Cache la Poudre River Basin for the Year 2020 . . . . .	71

<u>Chapter</u>	<u>Page</u>
4.5 The 2020 Reuse Model . . . . .	66
4.5.1 <i>Municipal Sector</i> . . . . .	66
4.5.2 <i>Industrial Sector</i> . . . . .	66
4.5.3 <i>Agricultural Sector</i> . . . . .	66
4.5.4 <i>Hydrological Conditions, Water Entries</i> . .	68
4.6 The 2020 Reuse Matrix "Drought" . . . . .	68
4.7 Disclosures of the Reuse Models . . . . .	75
4.7.1 <i>The 1979 Models</i> . . . . .	75
4.7.2 <i>The 2020 Reuse Model</i> . . . . .	76
V CONCLUSIONS AND RECOMMENDATIONS . . . . .	79
5.1 Conclusions . . . . .	79
5.2 Recommendations . . . . .	80
REFERENCES . . . . .	82
APPENDICES . . . . .	84
APPENDIX A: WATER BALANCE DIAGRAMS FOR THE YEAR 1979 . . . . .	85
APPENDIX B: DOCUMENTATION OF DATA . . . . .	134

<u>Figure</u>		<u>Page</u>
4-5	The 1979 Reuse Model - Scheme II . . . . .	65
4-6	The 2020 Reuse Model Drought Conditions . . . . .	72
4-7	The 2020 Reuse Model Drought Conditions . . . . .	73



## LIST OF FIGURES

<u>Figure</u>		<u>Page</u>
2-1	Line Diagram of the 1970 Water Transfers in the Aggregated Cache la Poudre Basin Water System . . .	6
2-2	Aggregated Matrix Representation of the Input-Output Model of the Cache la Poudre Basin Water System . . . . .	7
2-3	Input-Output Model for the South Platte River Basin Water Resources System. Magnetic Board Matrix Display . . . . .	9
2-4	The Hierarchical Structure of the Various Reuse Forms as Defined by Turner . . . . .	11
2-5	Basic Line Diagrams Depicting a Sequential Reuse System and a Recycle Reuse System . . . . .	13
2-6	Line Diagram for the Defined Reuse Forms in the South Platte River Basin . . . . .	15
2-7	Schematic Displaying the Principles of "Creating" Additional Water by Recycle Reuse . . . . .	16
2-8	Bengoechea's (1979) Schematic to Represent Sequential Reuse on the Input-Output Matrix . . . . .	20
2-9	Schematic to Depict the Position of the Input-Output Matrix in the Systems Analysis Process . . .	24
3-1	Areas of Occurrence of the Various Reuse Forms on the Reuse Input-Output Matrix . . . . .	29
3-2	Principle of the "Dummy" Transfer Component . . . .	33
3-3	Factors Related to the Supply and Demand of Water Resources System . . . . .	40
4-1	The Area of Investigation: The Cache la Poudre River Basin . . . . .	44
4-2	Schematic of the Cache la Poudre River Basin . . .	47
4-3	Map of Existing Canal and Reservoir System in the Cache la Poudre Valley . . . . .	48
4-4	The 1979 Reuse Model - Scheme I . . . . .	61

## CHAPTER I

### INTRODUCTION

#### 1.1 Purpose of Investigation and Project Goals

Today many water resources systems are considered to be in an "apex-state" relative to the utilization of their waters. Because of still continuously increasing water demands in such systems, water reuse may become an attractive alternative to augment their water supplies.

The methodology for planning and evaluation of water reuse in these normally complex systems is developed in Volume I. In Volume II, the input-output water balance model is developed and applied as a water reuse planning tool.

In water supply planning the identification of the important system components has to be done in a manner such that the decision makers in society are able to perceive the system sufficiently to have a sound basis for making feasible decisions. If water reuse is a proposed alternative, the concept must be presented in an easily understandable way to the prospective users in order to minimize possible user opposition. An engineering-planning tool is needed to represent and visualize a water resources system for documentation and alternative development. The input-output model is ideally suited for this purpose.

The input-output concept was originally introduced by Leontief (1951) into the economic theory. The present work succeeds other adoptions by De Haan (1976), Hendricks et al. (1977), Reitano (1978), and Bengoechea (1979), which mainly focus on the water transfers between the individual system components, i.e., the physical pathways of distributing water to the various users.

The objective of this research is to adapt the method of input-output modeling to water reuse planning. This is done by demonstration using an actual case study. The potential of the modified input-output model is explored as a tool for water reuse engineering.

## 1.2 Approach

The theoretical part of this investigation reviews first the input-output model as a medium for systems analysis and highlights the principles of input-output modeling. Subsequently, the different forms of water reuse are identified. A rationale is sought to justify the adaptation of the input-output model to water reuse planning. The theoretical part elucidates also all the necessary changes in the modeling approach vis-a-vis past applications of the input-output model for water transfer models.

This part is followed by a practical demonstration of the developed methodology on an actual case study. This case study uses the Cache la Poudre River drainage in Northern Colorado. Two models are constructed: one for the year 1979 for documentary purposes and the other for the year 2020 under assumed drought conditions to document the planning potential of the input-output model. The final chapter addresses the emerging conclusions and recommends further developments of the methodology.

## CHAPTER II

### REVIEW OF THE INPUT-OUTPUT PRINCIPLES AND THE CONCEPT OF WATER REUSE

#### 2.1 Principles of Input-Output Modeling

When Wassily Leontief introduced the input-output model in the early 1930's, he had in mind the depiction of the U.S. economy involving the relationships and interactions of different industries. By using the input-output model as a conceptualization of the quite complex economic system to identify the system's structure, he was able to explore and quantify the interactions of the individual industries of the system.

When applying the principles of input-output analysis to water resources systems, so called "internal components" take over the roles played by the various industries in Leontief's model. These internal components represent the selected features of the water resources system, whose relationships and interactions have to be investigated. These features can be water conveying facilities, such as rivers, canals, ditches; water storage facilities, such as lakes, groundwater reservoirs and surface reservoirs; and water use systems, such as municipal water supplies, industries, and agriculture.

In addition to the internal components, the set of system components is completed by the so called "entry components" and "exit components." Through the entry components, water enters the water resources system under consideration; and through the exit components, the water leaves it. If we consider the system components under the aspect of "origins" and "destinations," then the entry components are only origins insofar as they do not receive water from the investigated system. The internal components can be considered as both "origins" and "destinations,"

because the water enters and leaves such components within the system. Finally, the exit components are the destinations of water, which leaves the system. The purpose of the input-output model is to assemble the individual system components in such a manner as to visualize the existing and potential relationships, i.e., the water flows between these components. The model uses a matrix format to represent the structural and functional characteristics of the water resources system.\*

Reitano (1978) describes the construction of the input-output matrix as follows:

"The rows of the matrix consist of the 'origin components' only, i.e., entry components and internal components. The columns of the matrix consist of 'destination components' only, i.e., internal components and exit components. The presence of a datum at the intersection between any row and column, i.e., the existence of a matrix element at that intersection, indicates an interaction related to flow from the row-correspondent system component to the column-correspondent system component."

In current applications of the input-output model to water resources systems, these data always represent the units of water transferred from the "origin component" to the "destination component." The bottom row of the matrix consists of the input totals for each respective system component, which serves as a destination, while the far right column consists of the output totals for each respective system component, which serves as an origin. Further columns of totals of various sorts can be used, relating to specific interesting subsets of water exchanges. The input totals in the matrix will coincide with the output totals for all internal components, therefore assuring an overall water balance for the system.

---

\*The structural characteristics depict the type of features which have to be considered. The functional characteristics point to the interaction of these features.

Figures 2-1 and 2-2 give a simplified graphical depiction of an input-output model in the matrix format for a water resources system, whose interactions between the system components are given by a line diagram. Such a matrix displays, in an easy to grasp fashion, the overall picture of the water resources system on one hand. On the other hand, it enables the investigator or decision maker to go into detail and explore the interrelationships between individual system components. Not only are existing interactions displayed by the data in the individual matrix cells, but also all possible, nonexisting relationships are visually displayed. An important attribute of the input-output model is also that each interaction is more accurately defined by its quantity in the matrix cell.

At this point, it is obvious that the resolution brought by the input-output model depends on the selection of the system components, which have to represent the water resources system. The system, with its numerous features, has to be aggregated into a manageable number of system components, which give a characteristic picture of the system.

The first step in abstracting a water resources system into a system which fits into the input-output analysis scheme, is to select a time frame and to define the system boundaries. All water activities overlapping these system boundaries have to be considered either as system entries or system exits. The next step is to identify, within a level of desired resolution, all components comprising the water resources system. These system components may be aggregated into sectors, for example, "transbasin diversion sector," "storage sector," "municipal sector," "industrial sector," and "agricultural sector." The inclusion

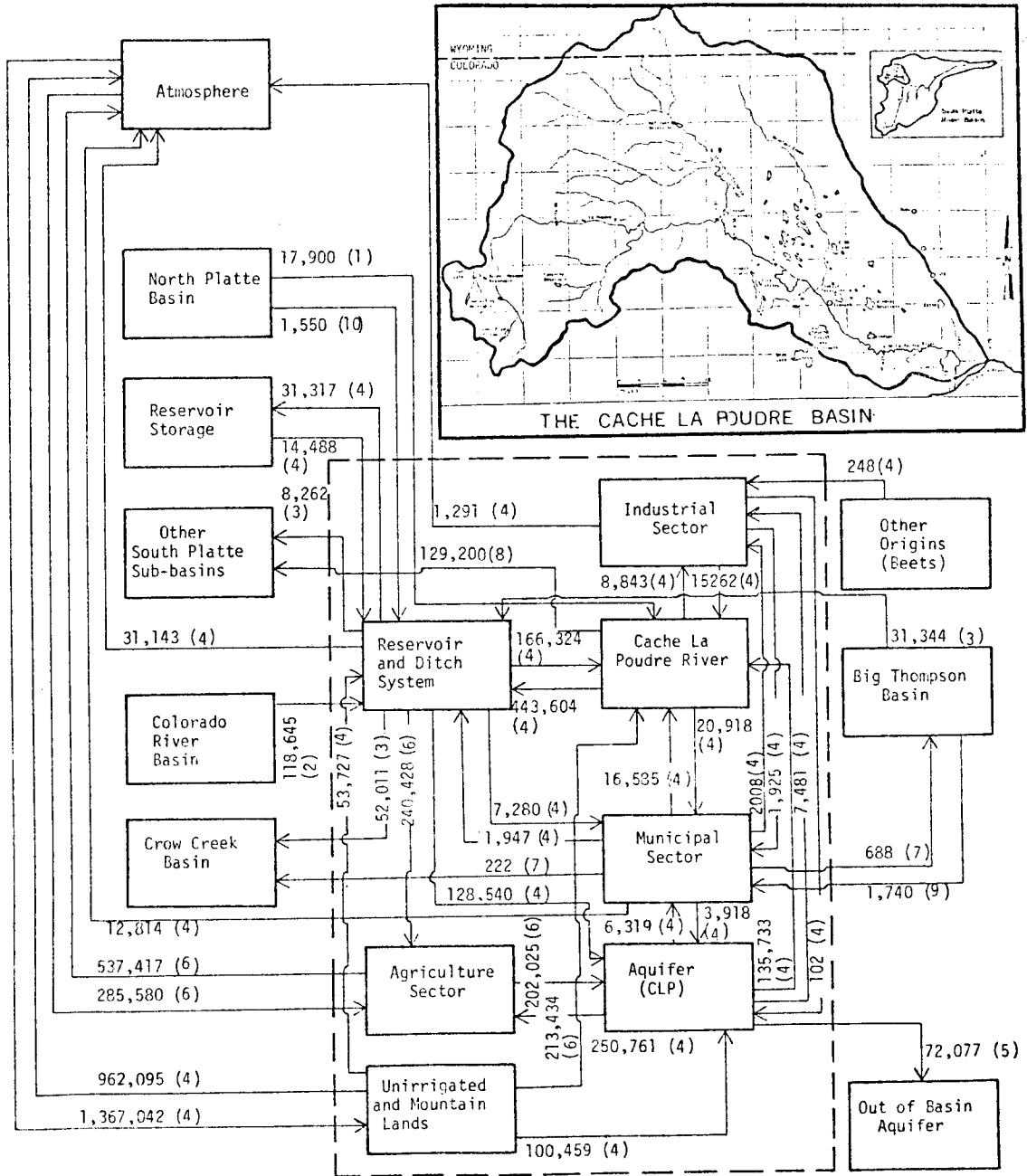

Figure 2-1. Line Diagram of the 1970 Water Transfers in the Aggregated Cache la Poudre Basin Water System (Reitano, 1978)

ORIGINS \ DESTINATIONS	TRANSBASIN DIVERSIONS	CACHE LA POUDR REACHES AND TRIBUTARIES	RESERVOIRS AND LAKES	DITCHES AND CANALS	MUNICIPAL SECTOR	INDUSTRIAL SECTOR	AGRICULTURE SECTOR AND OTHER LANDS	EXITS	OUTPUT TOTALS	USE TOTALS
ENTRIES	236,880	0	14,488	31,344	1,740	248	1,652,621	0	1,937,321	
TRANSBASIN DIVERSIONS	0	17,900	120,195	0	0	0	0	98,785	236,880	
CACHE LA POUDR REACHES AND TRIBUTARIES	0	926,948	33,655	409,949	20,918	8,843	0	174,537	1,529,513	8,843
RESERVOIRS AND LAKES (1)	0	230,229	9,785	206,965	6,319	7,481	220,699	134,537	816,015	232,081
DITCHES AND CANALS	0	71,828	277,607	45,443	7,280	0	233,163	60,273	695,594	233,163
MUNICIPAL SECTOR	0	16,585	3,972	1,893	80,849	20,008	0	13,724	119,031	28,206
INDUSTRIAL SECTOR	0	15,262	102	0	1,925	1,452	0	1,291	20,032	1,452
AGRICULTURE SECTOR AND OTHER LANDS	0	250,761	356,211	0	0	0	0	1,499,511	2,106,483	
INPUT TOTALS	236,880	1,529,513	816,015	695,594	119,031	20,032	2,106,483	1,937,321	7,460,069	503,745

(1) Aquifer is included among reservoirs.

Figure 2-2. Aggregated Matrix Representation of the Input-Output Model of the Cache la Poudre Basin Water System (Reitano, 1978)



of a specific system component into the model depends upon the purpose of the whole input-output model and on the component's importance for that purpose.

To illustrate the above outlined principles of water resources analysis by an input-output model, Figure 2-3 gives an example of a comprehensive analysis for the South Platte River Basin water resources system. The actual display of the matrix is on an eight foot by eight foot metallic board with color-coded magnetic strips.

The matrix is a format to visualize the results of an input-output analysis suitable for display in various forms depending upon the sophistication required by the user. It can be constructed graphically as a simple form. It can be displayed on a magnetic board as it was done by members of the Environmental Engineering Program at Colorado State University for the South Platte River system, the Cache la Poudre system, and for the water system of the City of Fort Collins. A sophisticated method is to computerize the display enabling the user to implement changes in the matrix immediately.

## 2.2 Water Reuse

2.2.1 Reuse definitions. This section provides the basic knowledge needed to explore the potential of the input-output matrix as a tool to plan and display water reuse in a water resources system. This knowledge will be developed by studying the water reuse systems in the South Platte River Basin in Colorado. Water reuse is broadly defined in Volume I as:

"A series of two or more uses that occur due to the acts of man in which a portion of the water originating from the first use and then used a second time has not passed through an unconfined gaseous state between uses."



Further, the different water reuse forms were defined in Volume I as they exist in the Western United States. The following water reuse forms are defined: unplanned reuse, planned reuse, sequential reuse, recycle reuse, and potable reuse. To provide compatibility and to further implement their use, the definitions, as worked out in Volume I, are used in this study. Hence, each term is defined as follows:

Unplanned Reuse: Unplanned reuse occurs when water, after a first use, is discharged to either a surface or groundwater body and the water is subsequently captured and put to use by a second or subsequent user *without coordination or planning between the first and second or subsequent users.*

Planned Reuse: Planned reuse is a deliberate second or repetitive use of water by the same or another user that *involves planning to coordinate the transfer of water between the first and second or subsequent users.*

Sequential Reuse: Sequential reuse occurs when effluent is discharged into a body of water or watercourse by the first user, often diluted by natural forces and then withdrawn, treated (if necessary), and used again for a different purpose.

Successive Reuse: Successive reuse is a subsequent use (of foreign water) by the water importer for a different purpose.

Potable Reuse: Potable reuse is the reuse of wastewater effluent after special treatment for *domestic purposes* including human consumption.

The hierarchical structure of the above defined reuse forms is presented in Figure 2-4. It is evident that the highest level, i.e.,

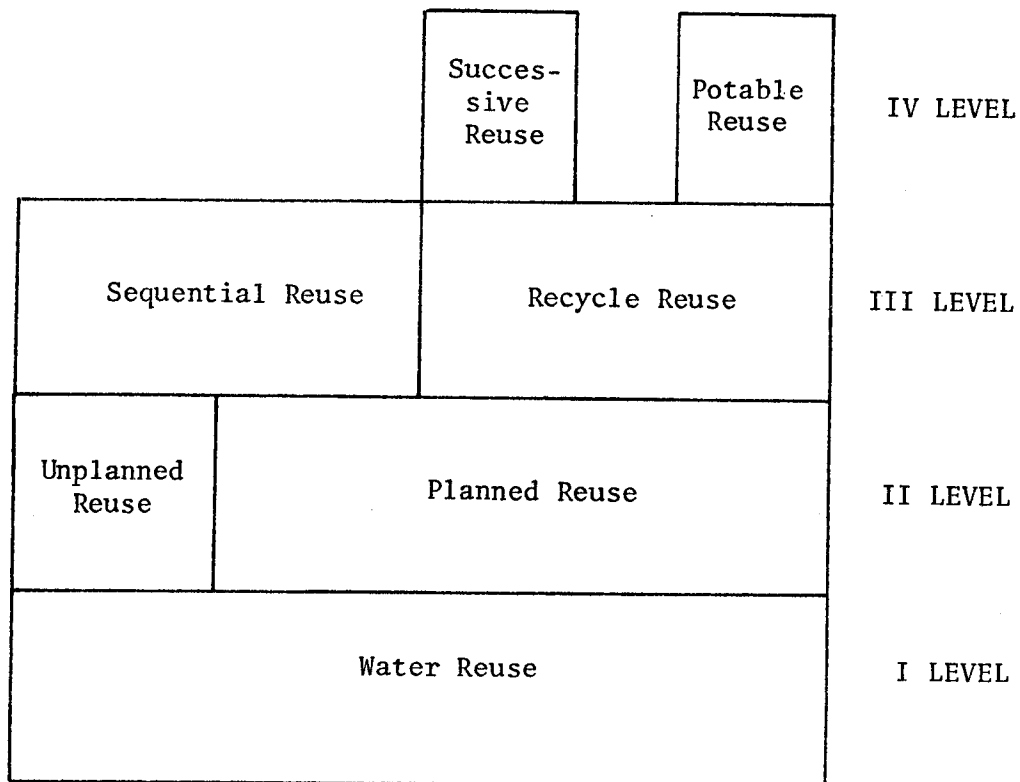

Figure 2-4. The Hierarchical Structure of the Various Reuse Forms as Defined by Turner (1981)

Level IV, is not completely defined. The higher forms of reuse on Level IV originate out of special cases in the South Platte River Basin. Studying further literature about water reuse, it seems that Turner's definitions cover all practiced forms of water reuse. Although it should be mentioned that the nomenclature designating reuse forms is unfortunately inconsistent in the literature. Therefore, the reader has to check each author's definitions carefully.

2.2.2 Reuse line diagrams. In the following, the six defined water reuse forms will be displayed by means of line diagrams which are pointing out the characteristics of each reuse. Two basic line diagrams are sufficient to display every possible system of water reuse. The proposed line diagrams are different insofar as the first one is designed to describe reuse systems in which the first and subsequent use systems are different; the second is suited to display "recycle"-type systems, in which first and subsequent use systems are the same. The main symbols of each diagram are:

- The square fields indicating the use systems
- The arrow indicating the transfer activity

"Transfer activity" is defined as the mode of moving the water from one use system to another. It includes:

- The planning degree involved in water reuse
- The treatment degree of the transferred water

Figure 2-5 shows the two basic line diagrams. The degree of planning and treatment is indicated by the number of horizontal lines representing the transfer activity arrow:

- one line -- unplanned reuse
- ==== two lines -- planned reuse

## Sequential Reuse System

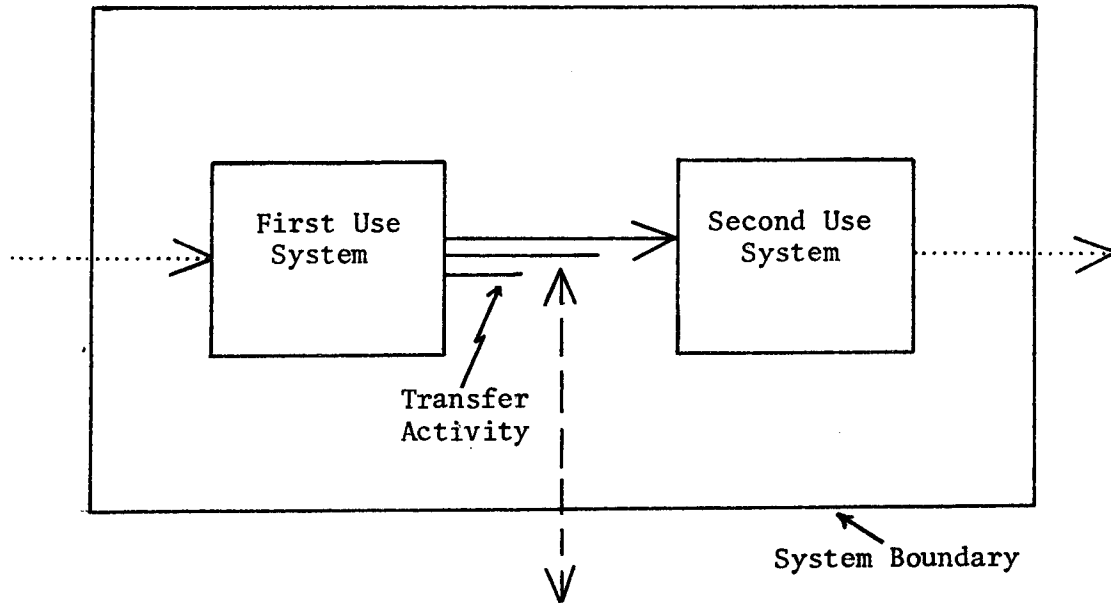

## Recycle Reuse System

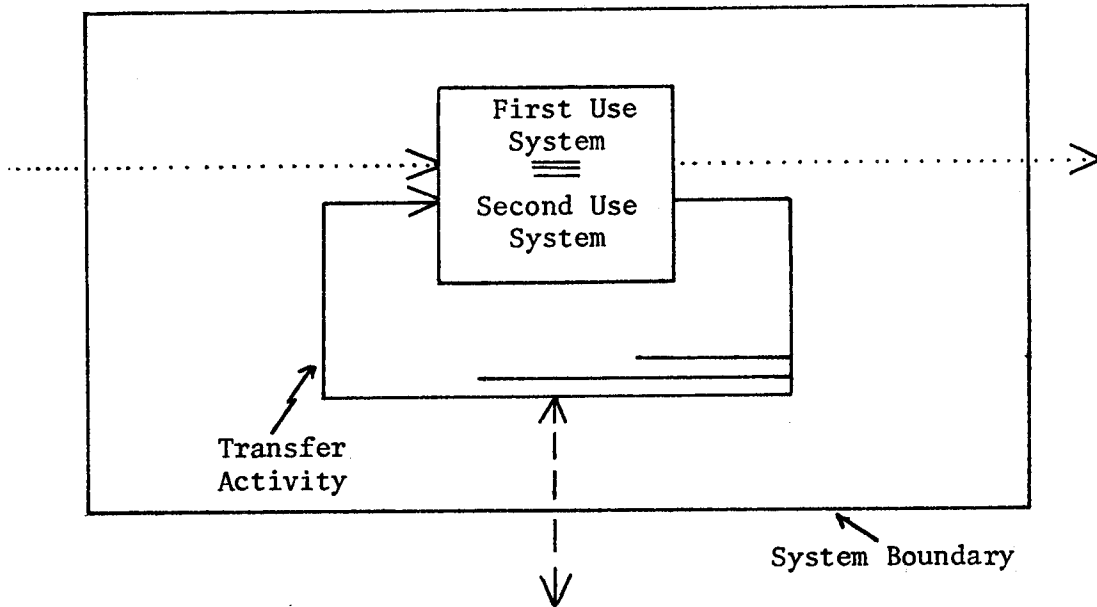

Figure 2-5. Basic Line Diagrams Depicting a Sequential Reuse System and a Recycle Reuse System

~~=====~~ three lines -- planned reuse with special treatment of the water to match specific reuse needs

The dashed arrow coming into the reuse system represents the water addition (makeup water) or water release (blowdown) during the transfer activity to or from the reused water. The water addition can be water to replace consumptively used water or water added during dilution in a natural waterbody. The dotted lines visualize the water input into the reuse system to the first use system and the output of the system following the subsequent use. In Figure 2-6 the two line diagrams are applied to the six defined reuse forms. It can be seen that the recycle reuse is, in general, the more mature planned water reuse form than the sequential reuse. Recycle reuse permits to squeeze the maximal amount of water out of the system.

2.2.3 The mechanics of developing "new" water by water reuse. The more the water requirements in a use system surpass the natural water supply, the more the added cost for formal planned reuse is becoming competitive with the added cost of other means of water augmentation. The mechanism of creating "new" water in terms of water reuse is basically: running each unit of water through several use entities before discharging the unit of water outside of the water use system. Hence, by using the water more than once in the water resources system, the total available water volume is augmented and "new" water is created. The mechanism is visualized in Figure 2-7 with a simplified flowsheet for recycled water reuse. By utilizing Volume A of makeup water as a supply, a total volume of  $(A + V)$  of water can be made available for use in the system. The necessary Volume A will be minimized by reducing the Losses L and the Blowdown B for the use system under consideration.

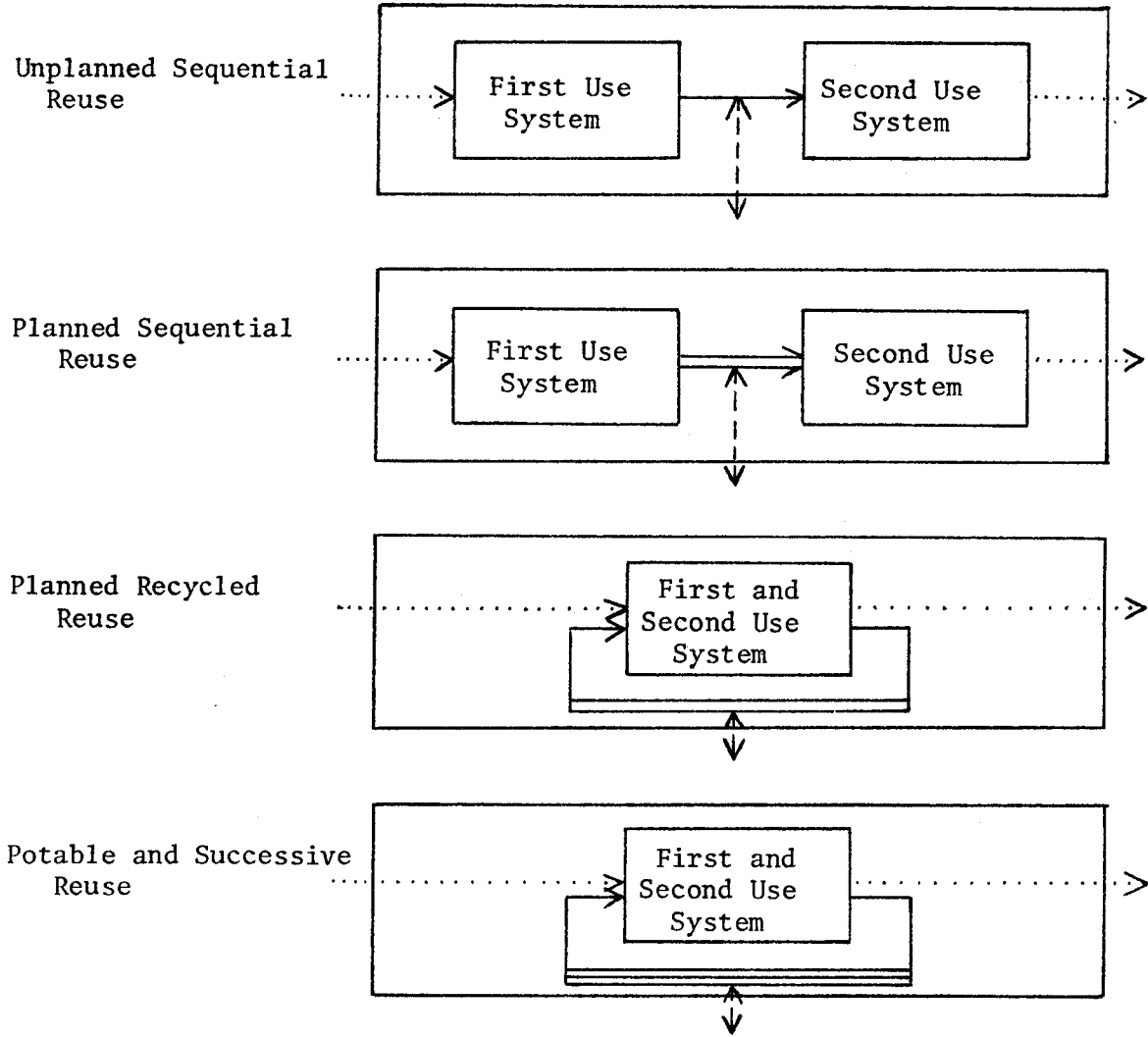

Figure 2-6. Line Diagram for the Defined Reuse Forms in the South Platte River Basin



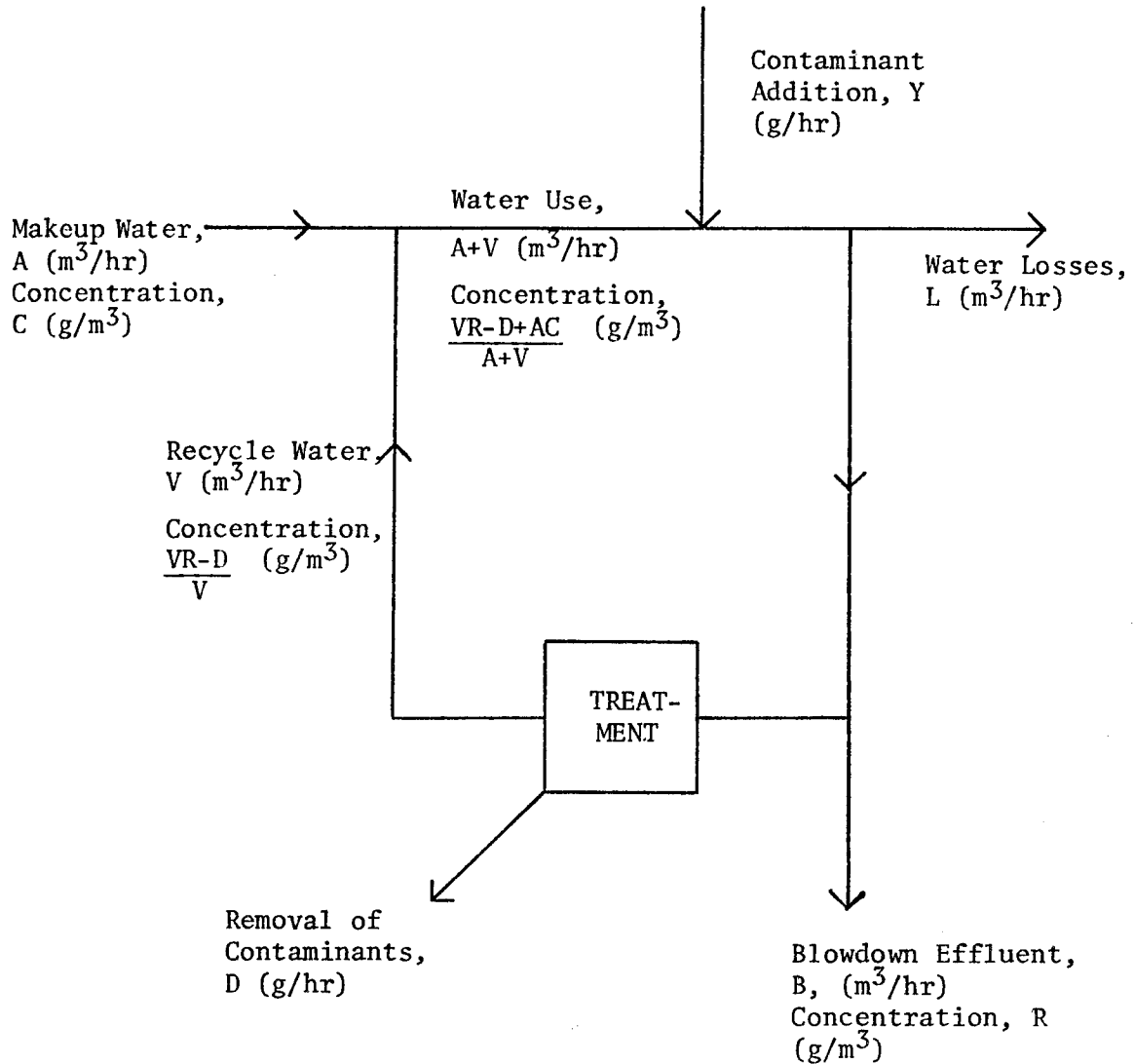

Figure 2-7. Schematic displaying the principles of "creating" additional water by recycle reuse. By utilizing Volume A of makeup water as a supply, a total volume of (A+V) of water can be made available for use in the system. The necessary Volume A will be minimized by reducing the Losses L and the Blowdown B for the use system under consideration.

As a consequence of this maximization, the water circulating in the use entity will have the maximal permissible concentration in terms of contaminants which are important for the considered water use.

To describe the degree of reuse in a water resources system, De Haan (1976) defines the *water reuse index*, which is the total utilized water divided by the original water input into the system. The maximal attainable value for the water reuse index is either determined by the consumption of the water or in terms of total contaminants. The water consumption, as defined by Turner (1981), is the transformation of water from its liquid form into its unconfined gaseous state (i.e., evaporation). The consumption is mostly influenced by the climate and by the water reuse form. In the United States, for instance, consumptive losses based on climate conditions vary between 20 and 60 percent for municipal water supply systems. Considering the water reuse form, the recycle water reuse may have the tendency to increase water consumption, for instance, in cooling systems of power plants where a greater portion of water is evaporated in recycle systems than in once-through systems.

With the exception of hydropower generation, which is a boundary case as a water use system because it involves practically no water consumption, each use of water in a system loads the water successively with physical, chemical, and/or biological contamination degrading the water to a point where it becomes unsuitable for any further use. Physical contamination is mainly caused by temperature changes or radioactivity. Principal chemical contaminations are due to:

- Increase in the dissolved minerals content
- Increase in  $\text{NH}_4^+$  and  $\text{NO}_3^-$  concentrations
- Increase in the heavy metals content
- Increase in TOC

Normally, the dissolved minerals content by chemical contamination is the limiting factor of the water reuse index. Biological deterioration is caused by bacteriological and virological contamination.

In general, the contamination and not the consumption of water is limiting the water reuse index in real water resources systems indirectly by the costs to reduce the contamination to an acceptable level. Although, the theoretical case exists where the water is reused under extensive treatment until it is totally consumed. In a normal case, the treatment costs per unit of water increase superproportional to an increase in the water reuse index. Further, reuse system inherent limitations to the reuse index are imposed by legal constraints; requiring for instance the

--consideration of water rights of downstream users,

--provision of a minimal streamflow within the water resources systems, and

--provision of a minimal streamflow out of the water resources system.

2.2.4 Water Reuse in Existing Applications of the Input-Output Model. In the applications of the input-output model during recent years by Hendricks and De Haan (1973), Bengoechea (1979), Reitano and Hendricks (1978), and Hendricks and Morel-Seytoux (1978) to identify the water use systems in the South Platte River Basin, naturally water reuse is also involved because of the inherent water scarcity in the described river basin. In these research studies, the flow of the water through the system is displayed giving information about the origin and the uses of the water units.

No case exists where there is an application of the input-output model with the goal to elucidate the different reuse forms in the system. In the application of these models, there is only sometimes a faint distinction between primary water uses and secondary water uses; making it difficult to trace the existing water reuses. Bengoechea (1979) gives, with a schematic depiction in Figure 2-8, an approach on how to identify *sequential water reuse* in an input-output matrix.

These previous state-of-the-art input-output models for water resources systems do not permit an easy reuse quantification. There is no way to recognize on the input-output matrix, how many times the water is recycled through a specific component because the rate of consumption in each cycle is not displayed by the internal component. Also, the qualitative, economic, and normative aspects of a certain reuse form cannot be assessed using the input-output models developed to date.

In the input-output model for the entire South Platte River Basin by Hendricks (1978), attempts were made to identify reuse forms. Some cells were marked based on color differentiations with "intended water reuse" and "industrial-municipal water transfer - no reuse." The "intended reuse" as displayed on the matrix would be a sequential reuse. To determine the content of these reuses, the user of the model must consult the accompanying report, which makes the gathering of this information quite cumbersome. Confusion may arise using the above system because not all reuse forms are identified making the assessment of the total reuse potential difficult.

Bengoechea (1979) introduces into his model of the Fort Collins' water system, the differentiation between "reusable water" and "non-reusable water." The terms "reusable" and "nonreusable water."

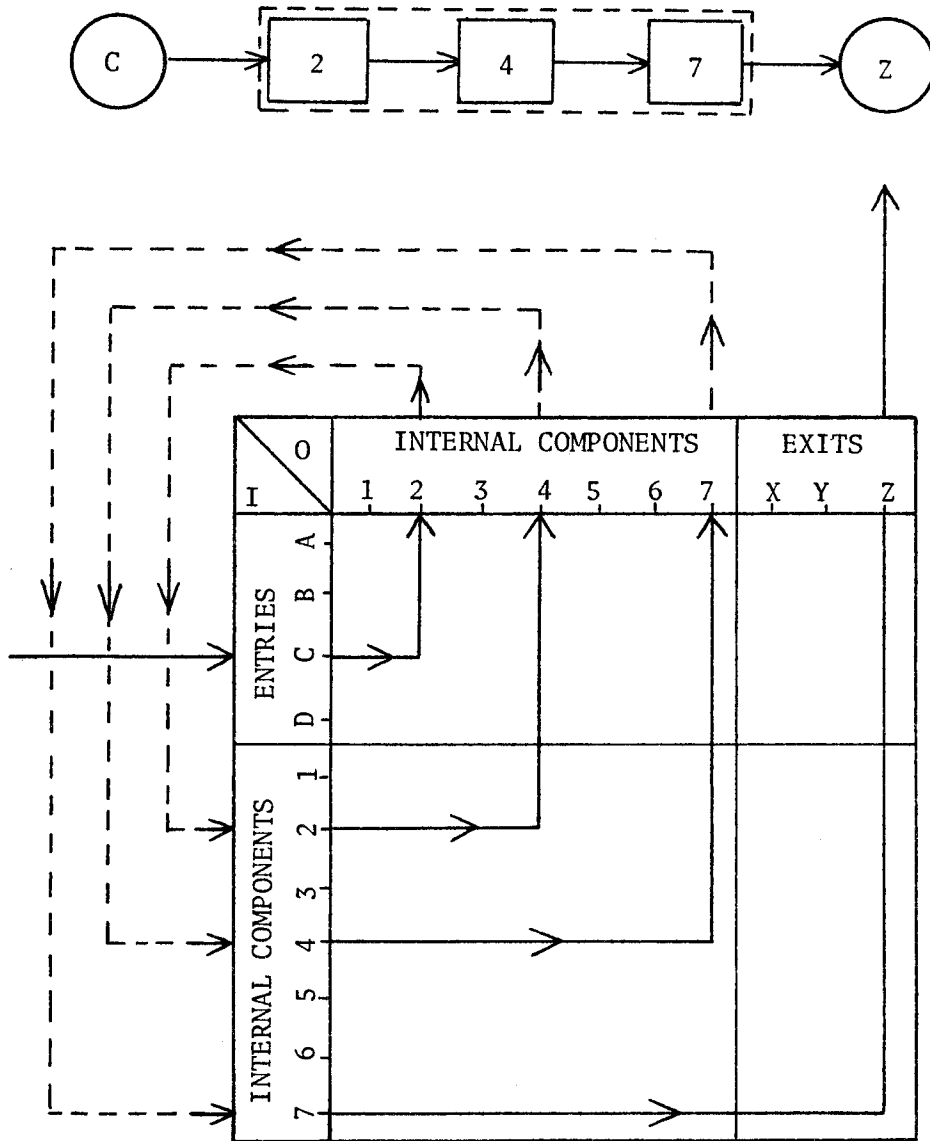

Figure 2-8, Bengoechea's (1979) Schematic to Represent Sequential Reuse on the Input-Output Matrix

respectively, are introduced into his model in a fallacious sense.

Bengoechea means by "nonreusable water" only water which is not available for recycle reuse due to legal constraints, but the water can be used for sequential reuse.

### 2.3 Why Input-Output Modeling for Reuse Analysis?

When applying systems analysis to a real water resources system, the selection of the suitable approach depends upon the purpose of the analysis and the characteristic features of the water system. Today, all water systems are developed to a certain degree. Therefore, it is now normally impossible to plan and develop a water resources system from nothing. Existing uses and earlier decisions about the structure of the system have to be considered as more or less flexible constraints in the planning process. As Hall and Dracup (1970) point out, water resources systems are in their very nature historically, politically, legally, physically, productively, technically, and economically. These properties can be expressed by physical, sociological, biological, economical, political, legal, geological, and agricultural parameters, some of which are quantifiable and some of which are not. Many of these complex water resources systems are evolved from tradition in an unplanned manner. This evolution guaranteed in very rare cases the development of an optimal system. Therefore, further planning and development has to begin from a basis provided by a nonoptimal system, which already bars the way to an overall optimal water resources development.

To further develop such water resources systems by a computerized decision process, all nonmathematical and nonquantifiable parameters have to be postulated to be nonexistent or must be substituted. This

can lead to fallacious results. Applying such an approach and describing the system only from a mathematically graspable point of view, much better water resources systems can be designed and built than the political and social realities would permit.

Based on the, not always easily to perceive, characteristics of water resources systems, decision makers often tended in the past to evaluate development alternatives based on intuitive preferences, which are functions of the decision maker's political and social background. It can be concluded, therefore, that optimization methods are not necessarily the core of system approaches to engineer water resources systems. Modeling and evaluation are often more important tools although they are less satisfactory or less available to the purist explanations than optimization approaches, which are mathematically elegant and tractable.

Input-output modeling for reuse analysis is an approach to simulate and evaluate the best practicable water reuse schemes in water resources systems having already a high degree of development. By using the input-output model, a complex system can be visualized in a simple and relatively cheap way. It is very suitable for policy level planning because changes in the policy can be demonstrated with ease by implementing them in the matrix. It can support the bargaining process to reach a decision as outlined by March and Simon (1966):

"When a number of persons are participating in a decision making process and these individuals have the same operational goals, differences in opinion about the course of action will be resolved by predominantly analytic processes, i.e., by the analysis of the expected consequences of action for realization of the shared goals. When either of the postulated conditions is absent from the situation, when goals are not shared, or when the shared goals are not operational and the operational subgoals are not shared, the decision will be reached by predominantly bargaining processes."

In other words, the matrix supports the exploration of the "indifference bands" of all parties. The analysis assumes that all solutions which are acceptable for everyone come close to an overall socially, but not mathematically, "optimal" solution because of the complexity of the system. It follows that the goal of the whole procedure is not an overall optimal solution, but highest agreement among all parties. Only this agreement will guarantee a proper functioning of the implemented system in the future.

The matrix display can consider the hierarchical relationships in the objective sets and the compatibility within sets of objectives through water mass balances, water quality requirements, etc. In addition, the input-output model can support the process in which first vaguely expressed goals and objectives are becoming crystallized as alternatives are put forth on the matrix and their impacts on the system are better perceived.

The analysis of water resources systems is not only a step-by-step process, but rather it is a dynamic process, which after a start up period has work proceeding concurrently on several tasks. The results and assessments of each stage of analysis are continually being fed back to alter or refine ongoing work or other tasks. These feedbacks are easily implemented and displayed on the input-output matrix. Figure 2-9 shows the place of the input-output matrix in the whole systems analysis process of a water resources system involving water reuse.

During the systems analysis, the objectives translate the desired futures into operational terms by stating the conditions to be met in designing a satisfactory solution. The desired futures can be displayed



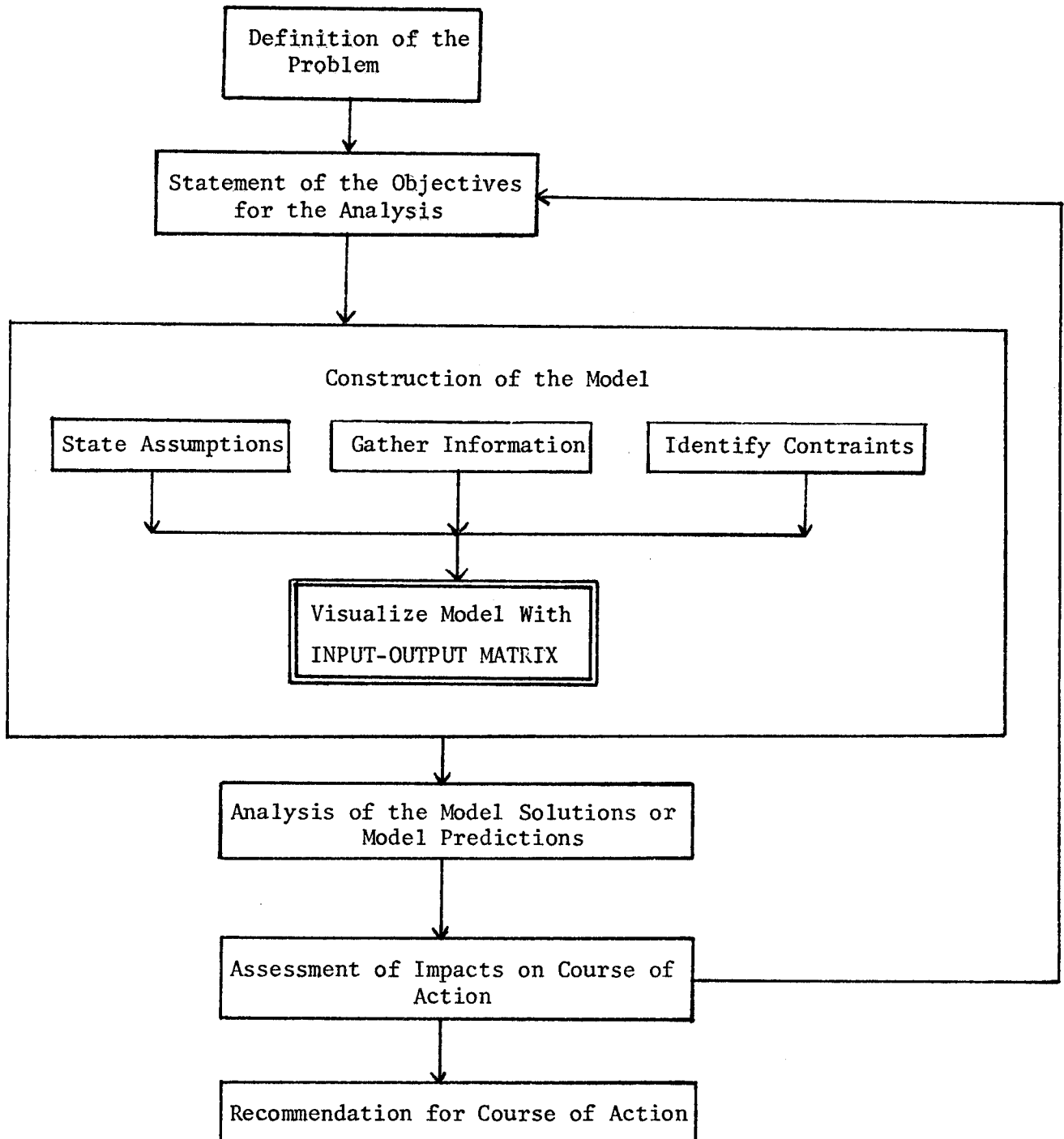

Figure 2-9. Schematic to Depict the Position of the Input-Output Matrix in the Systems Analysis Process

on the matrix and then different solutions can be worked out by rearranging the matrix. The merits of each solution can be judged with ease by the deciding parties because of the visible and clear display of the conditions.

Also of great value is the input-output model during the stage of decision implementation. It can contribute to a better understanding between system analyst and future users of the water resources system because the matrix displays the future and can point to necessary courses of action. The model allows an early introduction of the ultimate user into the decision making process. The matrix is a medium to maintain the communication throughout the project, which is of crucial importance for a smooth implementation of the decisions.

CHAPTER III  
ADAPTION OF THE INPUT-OUTPUT MODEL  
TO WATER REUSE SYSTEMS

3.1 Methodology

The purpose of the analysis and the character of the decision maker served by this analysis provide the basis for developing approaches to model and analyze water reuse. The input-output model has to facilitate the planning and deciding tasks for the decision maker. Many decision makers, who are determining the final execution of proposed water use schemes, are political authorities with little or no special knowledge of the problems related to the different modes of water use. Therefore, the decision supporting input-output model, has to be prepared in such a fashion as to spark the decision maker's interest to explore the matrix and with it the system. The input-output matrix must provide a display which needs little indoctrination to understand its main features. Thus, the most important characteristics of the new reuse model has to be "appealing," "easily readable," "easily understandable," and "simple to construct." This paragraph proposes a way for such an input-output model to be developed from the existing input-output analyses, which mainly provided water transaction tables in the past.

The new proposed reuse matrix focuses only on existing and future water use systems considering the water transfer systems of secondary importance. This is the prominent difference to the past applications of the input-output matrix, which have considered a water resources system as a whole, i.e., the water transactions considered were not only the ones with beneficial use but also the ones which are solely water transfers. One may object that the existing water transfer systems are

of great importance for a water resources system, because of the already done capital expenditures to develop them and because existing and from tradition evolved patterns, for example, the agricultural distribution systems, are difficult to change. On the other hand, it seems that such difficulties decrease in magnitude when a resource starts to get scarce. Under such circumstances, people begin to become more flexible towards more radical changes and unconventional solutions in their existing environment, which also includes the water resources system. Therefore, it is appropriate to suggest to neglect the transfer system as a first approximation because water reuse planning starts to become serious only when water is becoming scarce and the higher unit costs of reuse water become competitive.

The "conventional" input-output matrix involving water transfer and water storage systems as internal components is easily modified to a "reuse" matrix displaying only the relevant use systems. The modification consists primarily of the removal or nonintroduction of transfer and storage components. This new "reuse" matrix possesses interesting features as can be seen in Figure 3-1. Each input from any given internal component, which is per definition a use system, can be traced to its uses or its exits. The disposition of water from each output can then be traced to other uses as it is changed to an input and the cycle repeated. The internal components must be selected in such a way that any given output can be followed to its next use without entering a common carrier or transit mechanism such as a river or a stream. This requirement poses some difficulties to fulfill, when the output of a use system is difficult to localize in a water resources system. This is the case with agricultural return flows, which

enter streams as nonpoint sources and which are difficult to assign to a specific subsequent use system. The problem will be addressed again and solved later in this text.

The schematic of the input-output matrix in Figure 3-1 can be used to demonstrate the inherent adaptability of the input-output model to water reuse. Water enters the model on the left through the "entry" sector entitled "C." Entry "C" could be native precipitation, carry-over storage, or a foreign water import. The entry "C" is picked up by an internal component "2" and transferred. The internal component "2" is a first use system. After the internal component "2" has used the water, internal component "4," another use system which can, for example, be a municipality or a power plant, picks the water up and uses it also, which has to be a form of water reuse. Return flows from "4" can then be an input to another internal component "7" such as irrigated agriculture. After use by "7," the water leaves the basin through exit "Z." At this point, it is important to mention that the arrangement of the internal components on the input-output matrix from the entry components down to the exit components has to be representative of the natural flow pattern in the considered river basin. All waters as shown in Figure 3-1 must enter through the primary water supply cells. Once water has been put into the model, it must be transferred between the various use sectors. Each internal component for the input is exactly the same as the internal component for the output. The horizontal "4" is identical to the vertical "4." Therefore, any entry in the cross-hatched diagonal is a recycle reuse entry. An entry in this diagonal indicates a transfer of water within the same component. A variety of methods can be introduced in addition to the matrix to determine the type of recycling, number of cycles, and other pertinent information.

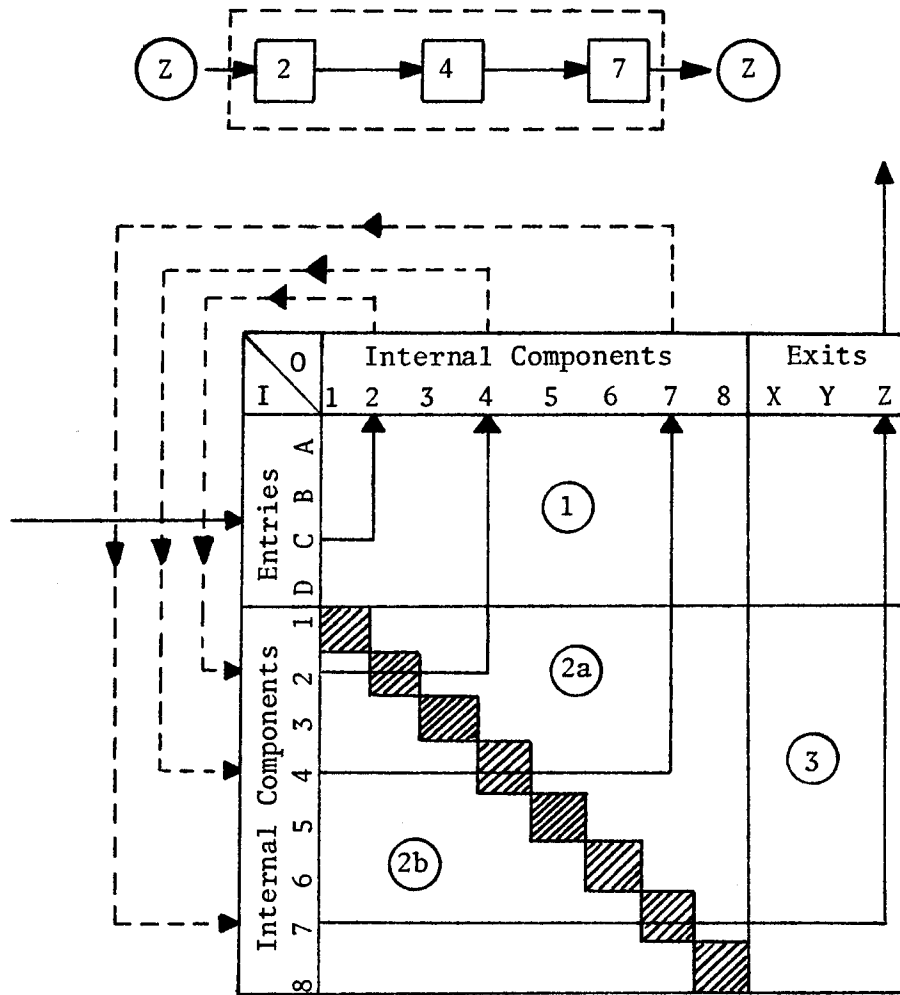

- (1) Cells for primary water supplies
- (2a) Cells for (un-) planned sequential reuse
- (2b) Cells for planned sequential reuse
- (3) Cells for potential reuse water
-  Cells for recycled reuse

Figure 3-1. Areas of Occurrence of the Various Reuse Forms on the Reuse Input-Output Matrix

Transfers that occur below the cross-hatched diagonal in Figure 3-1 are likely to be planned sequential reuses. The transferred water must be pumped back up to the "upstream" user because of the layout of the matrix. Any pumping upstream indicates an intentional reuse system that involves capital expenditures for construction. The importance of constructing the model in accord with the natural flow pattern in the basin is illustrated by this point.

Transfers from components below the recycle reuse diagonal to components above the diagonal can be either planned or unplanned sequential reuses. These "cross-diagonal" transfers indicate a downstream transfer of water that follows the natural flow pattern of the basin. Hence, it cannot be decided if the reuse is intentional or just by chance because pumping is not necessarily involved. Transfers to the exit sector can be viewed as potentially reusable water. Transfers of such water to use systems could be made further upstream, in the matrix more to the right, or captured at the exit point and pumped back to beneficial uses. In a total reuse system, the only exits would be to the atmosphere by consumptive use or to some other nonreusable location such as deep aquifer storage for toxic wastes.

Of importance in constructing the matrix is the aggregation of the water resources system and the selection of the internal components. The approach to aggregate the system remains essentially the same as for the developing of the input-output water transaction tables. Enough characteristic internal components have to be defined to be able to give an accurate picture of the modeled system and to grasp the relationships, which are ruling the system. On the other

hand, the number of internal components should be kept on the absolute minimum for a small and easily tractable matrix display.

The internal components, which have to be use systems, are chosen to represent the main water users in the water resources system. Minor water consumers can be lumped together in single internal components. The definition of "main" and "minor" is given by the required resolution of the model. The crudest reuse model with the least resolution would be based on a division of the water resources system in just the three use system sectors "municipal use systems," "industrial use systems," and "agricultural use systems."

The definition of a use system is of importance for the purpose of modeling water reuse: "A use system is a man-made or man-influenced system, which utilizes water for a beneficial purpose." In all water resources systems, certain use systems exist whose outputs are not clear to locate, for example, in the case of agricultural return flows entering a stream as nonpoint sources. The modeling of such systems requires the introduction of a "dummy" transfer component in addition to the internal components representing the use systems. To illustrate this principle, the case of agricultural return flows is used to illustrate this dummy transfer component.

All outputs from agricultural systems, which would enter a stream as a diffuse source, are considered to be inputs to the dummy transfer component appropriately called "return flow" in this case. Use systems, which are using water from streams fed by agricultural return flows or groundwater pumped from exploiting aquifers supplied by infiltration of irrigation water, are therefore getting their share of agricultural return flows from the dummy transfer component "return flow." Their share of agricultural return flows cannot be explicitly assigned to a



specific agricultural use system in the function of an "origin." Figure 3-2 illustrates these principles in a simplified form. Usually it is necessary to introduce only dummy transfer components for the agricultural return flows into the matrix. Return flows from the municipal and industrial sector are normally easy to locate and to assign to subsequent users. The location of the dummy transfer component in the matrix is preferably at the beginning of the internal components, i.e., towards the left of the matrix, to prevent the disruption of the display as exposed by Figure 3-1.

To elucidate the reuse practices in the existing water resources system or to plan future reuse by an input-output matrix, using use systems as internal components, two schemes are proposed. Each of these schemes displays the practiced or proposed reuse focusing on special characteristics of the investigated water use area. In general, these characteristics could be:

- the quality of the water, which is transferred to the internal component,
- the reuseability of the transferred water units, considering legal or other normative constraints, or
- the form of applied reuse based on the definitions of the various reuse forms.

3.1.1 Scheme I. This scheme has the different reuse forms and the legal reusability of the water units as a theme. The different water reuse forms are shown by underlying the data in the individual matrix cells with different colors according to the following distinctions:

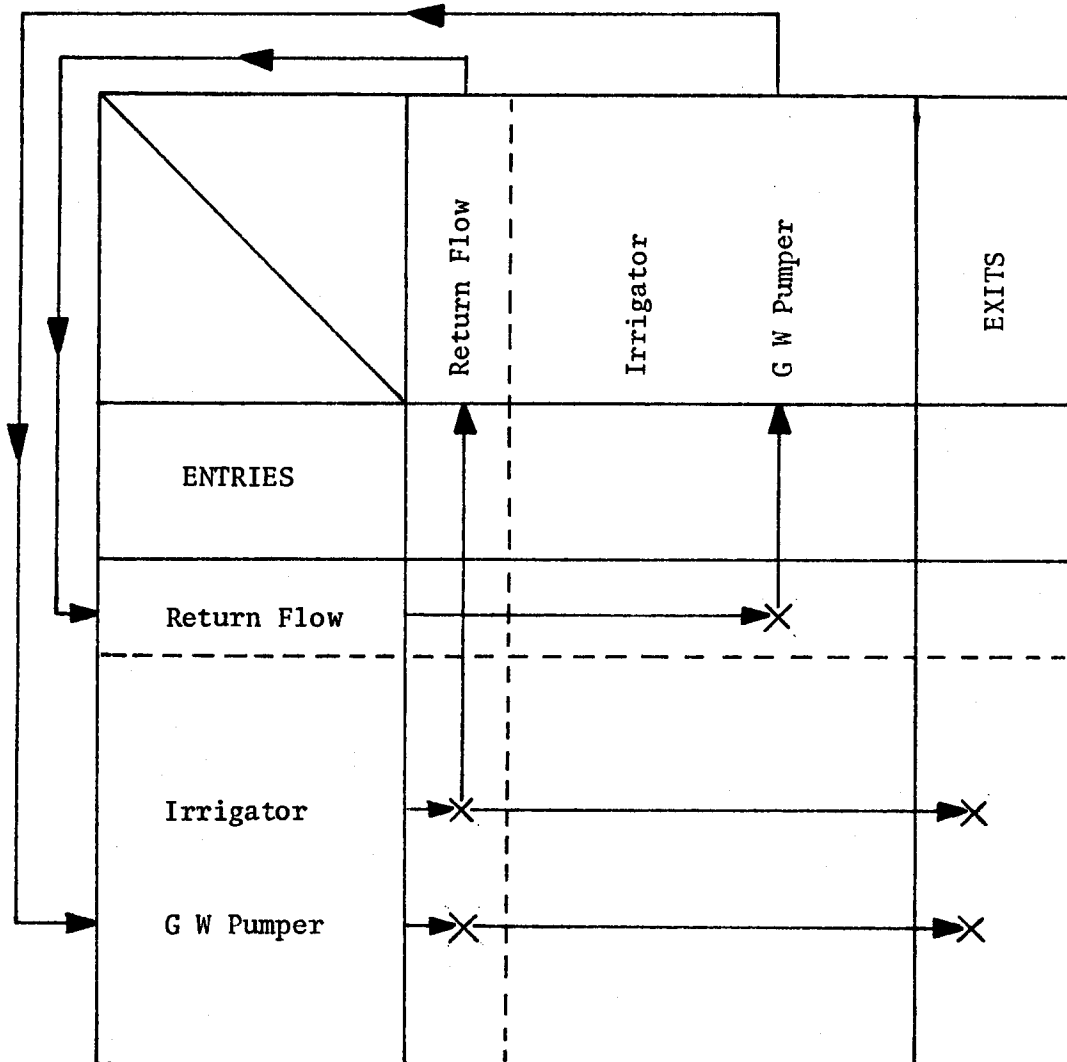

Figure 3-2. Principle of the "Dummy" Transfer Component

In the example, the use system "Irrigator" is origin for water to the "Dummy" transfer component "Return Flow" because agricultural return flows are nonpoint sources, and to an "Exit" component due to evaporation.

The use system "G W Pumper" pumping from an aquifer, which is supplied by agricultural return flows, is destination for water from the component "Return Flow." The return flows of "G W Pumper" themselves go partially back to the dummy transfer component "Return Flow."

COLOR	DESIGNATION
Red	Recycle reuse
Orange	Sequential reuse
Dark Green	Water at least partially available for sequential and recycle reuse
Light Green	Water not available for recycle reuse (water available only for sequential reuse)
Dark Blue	High quality primary water
Light Blue	Nonprimary unused water

To further enhance the understanding of the displayed system, a report can be prepared. This report could contain line diagrams giving additional information concerning the occurring reuses in the system. In this scheme, the blue colors point to unused, normally high quality waters which can be used with only little treatment. The reddish colors, orange and red, indicate that these water units are used at least twice in the water system. Hence, they have gone through a reuse cycle at least once. These colors also imply that the water quality has to be checked for further reuse considerations. The greenish colors are restricted to the exit and dummy transfer columns, identifying the water units going out of the water resources system, which are under certain circumstances reusable.

These colors enable the decision maker to immediately see how the water is distributed and where reuse happens. They also show who gets high quality water and if this distribution is optimal from a standpoint of efficient water use. The concept behind Scheme I considers, in addition, the legal aspects of water reuse in the investigated river basin in such a way that it displays the reuse possibilities in the light

of legal constraints. Water which can only be sequentially reused is clearly identified by the light green color.

If the use system columns could be grouped according to decreasing water quality requirements from the left to the right, without disturbing the spatial succession of the internal components along the river too much, then an eventual potential for water exchange could be made more visible. High quality water showing up in a far right-hand column would indicate a "waste" of good water for use with low quality requirements. If this rearrangement of user components is impossible, the labels for the different sector components could be colored according to their specific water quality requirements.

The labels designating the internal components may be colored according to the sector they are belonging to. For instance,

COLOR	SECTOR
Light Blue	Municipal
Orange	Industrial
Brown	Agricultural

This color coding facilitates the identification of specific use systems because the individual use systems are no longer aggregated into sectors as in the water transaction tables of past input-output analyses.

3.1.2 *Scheme II*. Scheme II focuses mainly on the quality of the transferred water units. Based on the observation that the input-output matrix already contains a differentiation into various forms (see also Figure 3-1), colors are used to display the quality degree of the transferred water between two use systems. Colors are also used to show the limits for water reuse for each internal component based

on a chosen contaminant parameter. For this purpose, the designation of each internal component on top of the "destination" columns is put on a label with the color of the maximal allowable contaminant concentration. Using such a display, the matrix shows where "gaps" are between existing contaminant levels and maximal allowable contaminant levels, pointing towards potential reuse locations in the system.

In addition, this approach gives also a display of the exchange potential for water with lower quality against high quality water. In general terms, it can be said that the theoretical maximal reuse potential in a river basin is utilized when every cell with a datum has the same color as the label of the corresponding internal destination component. Sometimes it is possible that a cell indicates a water quality which is worse than the allowable one according to the color coding of the receiving destination. This is tolerable if appropriate dilution of the lower quality water with high quality water in the destination system is assured. The dilution can be assessed by comparing the data of the cell displaying low quality water with the total input to the destination system.

To make the quality differentiation, the following colors are proposed to be used:

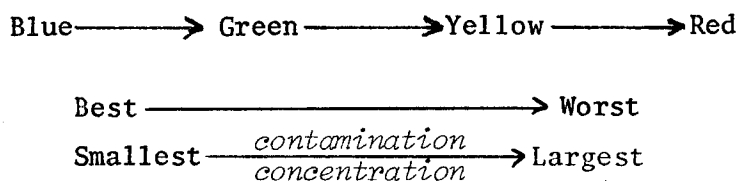

This color code follows a scheme proposed by Liebmann (1969), who displayed the water quality of European waterbodies with color differentiations. Blue is the color for the lowest contaminant level range, i.e.,

for high quality water. This color normally arouses in people feelings towards something "good." The worst or highest contaminant concentration is identified by red. The intermediate concentration ranges are shown by green and yellow,

As a first contaminant parameter making reuse considerations, it seems appealing to use the salinity or dissolved solids content (TDS). During each use cycle, the salinity of a water unit is increased. Its removal is only possible with very expensive treatment processes, normally not applied in water resources systems.

Appendix B gives the "maximal allowable salinity levels for beneficial uses in mg/l TDS," which have to be used to assign the colors to the labels of the internal components. The following list proposes ranges of contaminant concentrations based on TDS and the corresponding colors for the individual water transfers:

COLOR	CONTAMINANT CONCENTRATION RANGES
Blue	0 to 600 mg/l TDS
Green	600 to 1,500 mg/l TDS
Yellow	1,500 to 3,000 mg/l TDS
Red	> 3,000 mg/l TDS

Scheme II should also be accompanied by line diagrams to give a more enhanced insight into the considered reuse systems.

3.1.3 Summary of the Methodology. The following gives a step-by-step summary of the methodology of constructing a water reuse input-output model:

- (1) Determination of the *purpose* of the model.
- (2) Definition of the *boundaries* of the investigated water resources system.
- (3) Decision about the *time frame* of the model.
- (4) Select *entry components, internal components, and exit components.*
- (5) Select *display scheme and color coding.*
- (6) Compile *data.*
- (7) *Display data.*
- (8) Check *mass balances* of matrix.
- (9) Highlight reuse systems by *line diagram.*
- (10) Use the model to *analyze* reuse opportunities.

### 3.2 Data Requirements

The necessary data and information to construct a meaningful water reuse input-output model is determined by the chosen resolution and the selected components for the matrix. In a water resources system, the information needed is always of physical and of nonphysical nature.

Data of physical nature are:

- precipitation data
- streamflows
- evaporation data
- water diversions
- seepage losses
- consumptive uses

Nonphysical data are:

- legal constraints as the inhibition of recycled reuse by law
- constraints imposed by tradition
- normative constraints

If a status quo has to be analyzed, these categories of physical and non-physical information have to be gathered by investigating the existing water resources system. In the case of analyzing a possible future system, a scenario has to be assumed and from this scenario the necessary data must be derived. The scenario providing the data basis can be defined as follows:

"A scenario is the resulting situation based on a scenario assumption set, which is a particular combination of assumed interactions of water users and predicted factors influencing the water demand and the water supply patterns,"

It is evident that using scenarios, the future cannot be predicted, but it enables the investigator to explore the response of the water resources system to certain combinations of events.

Figure 3-3 points out the factors related to supply and demand of water in a water resources system and shows that the scenario assumption set gives the boundary condition for the situation to be modeled. Table 3-1, adapted from Reitano (1978), enumerates the necessary information to grasp a "total" water resources system.

During the process of data gathering, the obtained information has to be cross-checked and sometimes adjusted to eliminate existing disagreements among them. The reason is that a lot of the organizations compiling and supplying data about a water resources system work quite independently of each other without comparing their data. Often also the data collected by these organizations may be erroneous either because of lack of proper measuring devices or methods or because the



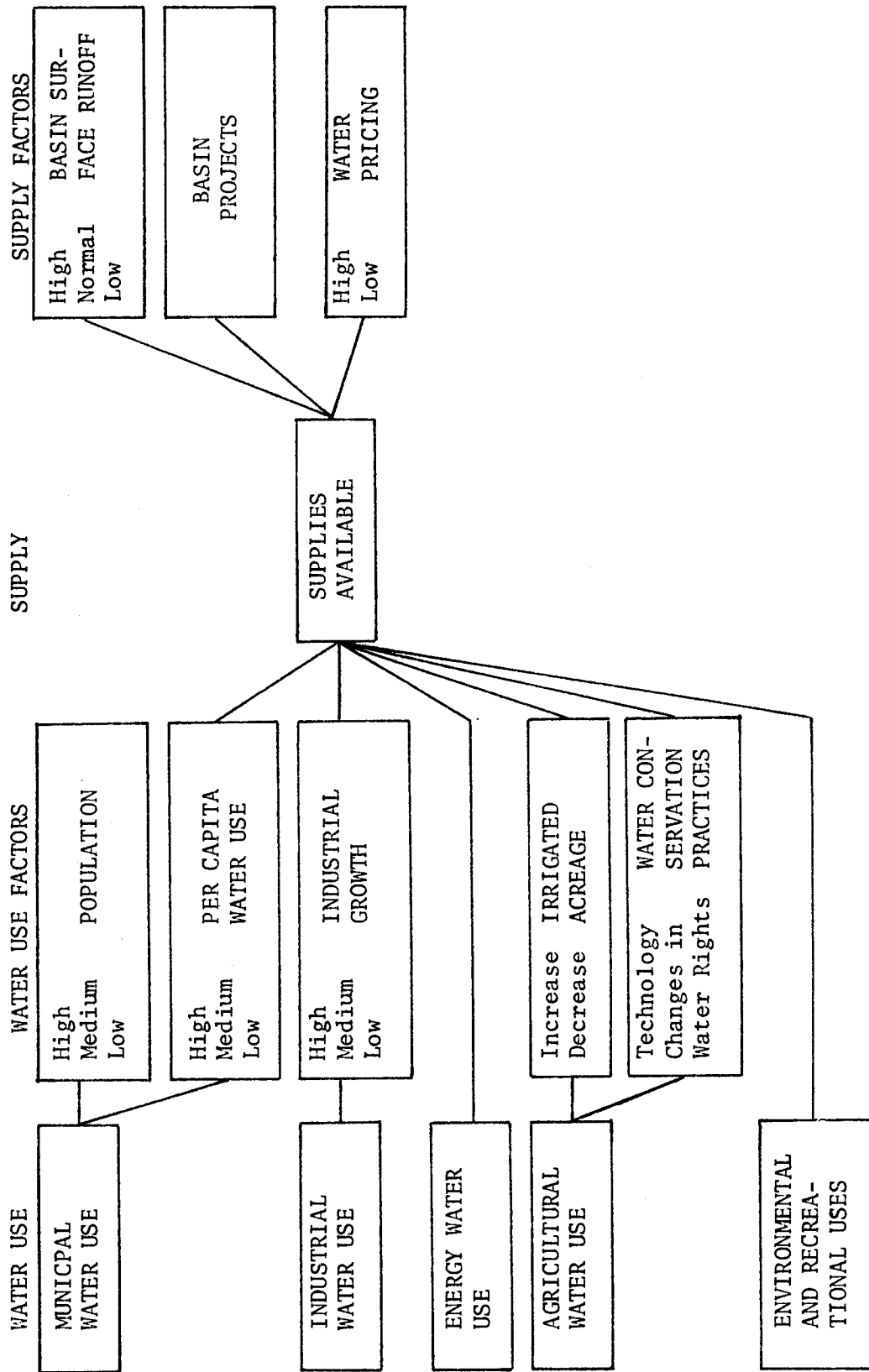

Figure 3-3. Factors Related to the Supply and Demand of Water Resources System

Table 3-1. Data Requirement for the Input-Output Model of the Cache la Poudre River Basin Water System (Reitano, 1978)

Sector	Required Information
Entries	Precipitation over the basin; aquifer depletion; reservoir depletion; out of basin aquifer inflows; sugar beet water; imports through trans-mountain diversions; imports through irrigation ditches.
Municipal Sector	Diverted amounts to water treatment plants; water treatment plant back-wash water uses; amounts distributed to the various users or to distribution systems by the water treatment plants; amounts distributed by the water distribution systems to municipalities and industries; municipal and other domestic return flows to sewer systems, sewage treatment plants, aquifer and atmosphere; infiltrations into sewer systems; amounts delivered by the sewer systems to the wastewater treatment plants; amounts discharged by the wastewater treatment plants into rivers, aquifer, lakes or evaporated.
Industrial Sector	Amounts supplied to each industry by municipal water distribution systems; amounts diverted from the river; amounts pumped from aquifer; amounts of water entering or leaving the industry together with the raw water or the products; amounts discharged to aquifer, to river, to wastewater treatment facilities and to urban sewer systems; consumptive uses.
Cache La Poudre Reaches and Tributaries	Diversions from each reach or tributary to agricultural ditches, water treatment plants, industries; amounts flowing into reservoirs and lakes; municipal and industrial discharges; agricultural ditch discharges; river flows at each reach extremity and at tributary confluences; surface basin runoff; groundwater runoff.
Agriculture Sector and Other Lands	Total precipitation over each type of land; evaporation; evapotranspiration; surface runoff to the river or its tributaries, reservoirs and lakes; aquifer infiltration; groundwater irrigation, surface water irrigation.
Reservoirs and Lakes	Aquifer infiltrations from lands, ditches, canals, lakes and reservoirs; amounts discharged by sewage treatment plants and rural septic tanks; total aquifer depletion or volumes received to storage; groundwater runoff to the river reaches and tributaries; aquifer agriculture withdrawals; aquifer domestic withdrawals; river flows to reservoirs and lakes; inlet flows to reservoir and lakes; transbasin diversion inflows; municipal discharges to reservoirs and lakes; reservoir stored and released amounts; reservoir and lake infiltrations into aquifer; reservoir releases to river, to irrigation ditches or to other reservoirs; reservoir municipal diversions.
Ditches and Canals	Diverted amounts; aquifer infiltrations; evaporation losses; releases to other ditches and canals or to reservoirs; amounts released to irrigation; amounts released to other river basins.
Exits	Evaporation from urban and rural domestic uses; industry consumptive use; evaporation from wastewater treatment plants; reservoir evaporation; ditch and canal evaporation; row land evaporation; agriculture evapotranspiration; amounts put in reservoir and groundwater storage; groundwater flows to other basins; irrigation deliveries to other basins; out of basin deliveries by the Cache La Poudre water distribution systems and water treatment plants; Cache La Poudre discharge into South Platte River.

data are manipulated to fit certain institutionally imposed patterns. These inconsistencies among data available from "outside institutions" have to be related to the accuracy of the data, which have to be assumed or estimated by the investigator, as for example, the amount of agricultural return flows. An accuracy in the matrix beyond one acre-foot is normally not justified in the model by the limited accuracy of the basic data. A further complication in compiling the necessary information is the difference between the water year as used as a basis for hydrological information and the "calendar year" used by domestic water supplies and industries. In general, this problem can be resolved by assuming the calendar year of the municipal and industrial sector to be equivalent to the water year without introducing a significant error.

## CHAPTER IV

### THE CACHE LA POUFRE RIVER REUSE MODEL

This chapter will apply the input-output reuse concept to the Cache la Poudre River Basin. It will demonstrate the principles of reuse modeling of a water resources system, which are outlined theoretically in the preceding chapter on a practical example.

#### 4.1 The Area of Investigation

The Cache la Poudre Basin is located in north central Colorado within the South Platte River watershed. The physical, human, legal, and administrative dimensions of the Cache la Poudre drainage have been outlined by several authors: Evans (1971); Skogerboe, Radosevich, and Vlachos (1973); Gerlek (1977); Reitano (1978); and are summarized in the following.

The Cache la Poudre River is a fourth order tributary of the Mississippi River, draining an area of 1,800 square miles. It originates near the Continental Divide at about 12,000 feet elevation, approximately 35 miles west of Fort Collins, drains a part of the eastern slopes of the Rocky Mountains and merges with the South Platte River about four miles east of Greeley.

Figure 4-1 gives a depiction of the Cache la Poudre watershed and the insert shows the relationship of the considered drainage to the superior river system. Over 50 percent of the drainage area of the Cache la Poudre River are mountainous, while the rest is made up by rolling plains. These plains provide the agricultural portion of the Poudre Valley. The two main towns, Fort Collins and Greeley, are located in the plains along the river.

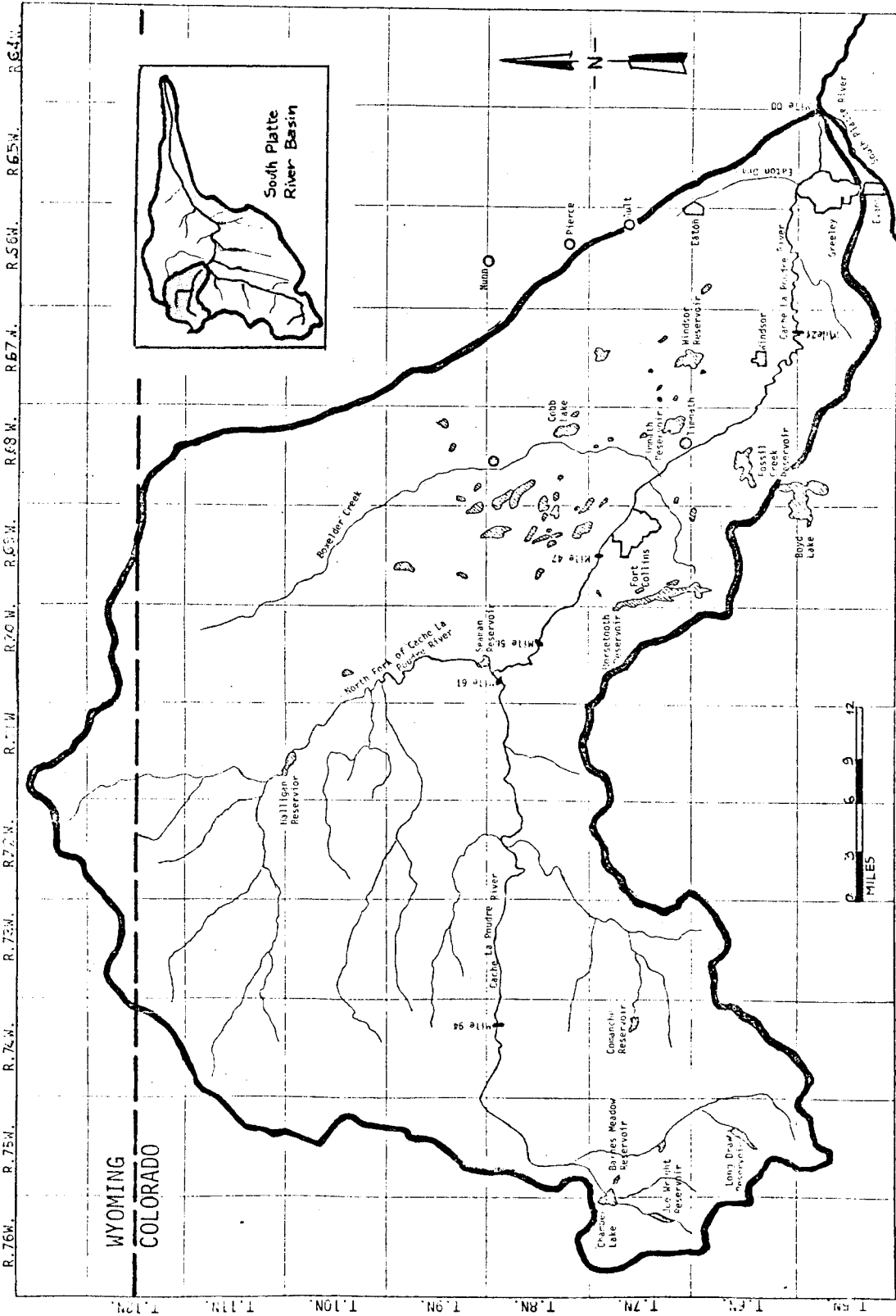

Figure 4-1. The Area of Investigation: The Cache la Poudre River Basin (Reitano, 1978)

The climate in the river basin can generally be characterized by low annual precipitation, a high rate of evaporation, low humidity, an abundance of sunshine, and a wide range of temperatures. The mean annual precipitation at Fort Collins is 14.19 inches and at Greeley, 12.51 inches. The maximum monthly precipitation usually occurs in May, while the minimum occurs in January. The mean annual temperature of Fort Collins is 48.1°F and 48.3°F in Greeley with the monthly averages varying between 23°F and 73°F.

The precipitation allows dry farming in the Poudre Valley although most successful farmers rely on irrigation. The growing season in the plains of the Valley is about 175 to 185 days, which is sufficient to raise most temperate zone crops, such as corn, sugar beets, potatoes, alfalfa, etc.

Today a man controlled regime is imposed on the Cache la Poudre River flows, which are altered in time and space by using storage reservoirs and a complicated system of ditches and canals. Before the influence of man on the Cache la Poudre hydrology, the flows in the river were determined by the runoff from melting snow and from perennial snowfields in the mountains and by precipitation. Very little virgin water accrues to the flow of the Cache la Poudre River after it leaves the mountains. The tributaries, Boxelder Creek and Fossil Creek, drain the lower plains area. They are intermittent and contribute very little surface flow to the Cache la Poudre River.

A great portion of the precipitation falling on the plains seeps directly into the aquifer underlying the valley in form of alluvia. This aquifer also provides the hydraulic connection to the surface streams for the return flows of agricultural irrigation.

Figure 4-2 shows a schematic of the Cache la Poudre Basin with the major man-made changes to improve the water supply in the Poudre Valley. The major elements in the man-altered system are the storage reservoirs and the transbasin diversions, the latter importing water from the Western Slope of the Rocky Mountains to the Cache la Poudre drainage. The aggregated capacity of all the reservoirs is approximately 350,000 acre-feet. The largest project for water importation is the USBR Big Thompson Project, which includes a major reservoir, the Horsetooth Reservoir (151,700 acre-feet), in the Poudre drainage. All the storage reservoirs in the plains are interconnected with a canal and ditch system, which is shown in Figure 4-3, to supply the waters to the various users.

This resulting system of water resources development and the associated uses completely dominate the natural system. In the upper reaches of the main stem, the streamflows are affected during the summer months by reservoir releases. In the plains reaches, the water diversions and returns dominate the streamflow patterns. The population served by this water resource system is both rural and municipal. The towns in the area experience at the moment a tremendous growth with the need for transfers of former agriculturally used water to municipalities. The two major towns of Fort Collins and Greeley are part of a rapidly expanding suburban growth area, contained in the "urban triangle" Fort Collins-Loveland-Greeley. The population of this triangle, which is superimposed to a great part on the Poudre Valley, is expected to increase to more than 400,000 people by the year 2020 (Skogerboe, Radosevich, and Vlachos, 1973).

Major industries in the Poudre Valley, some with a need for large amounts of water, are Eastman Kodak in Windsor, Hewlett-Packard and

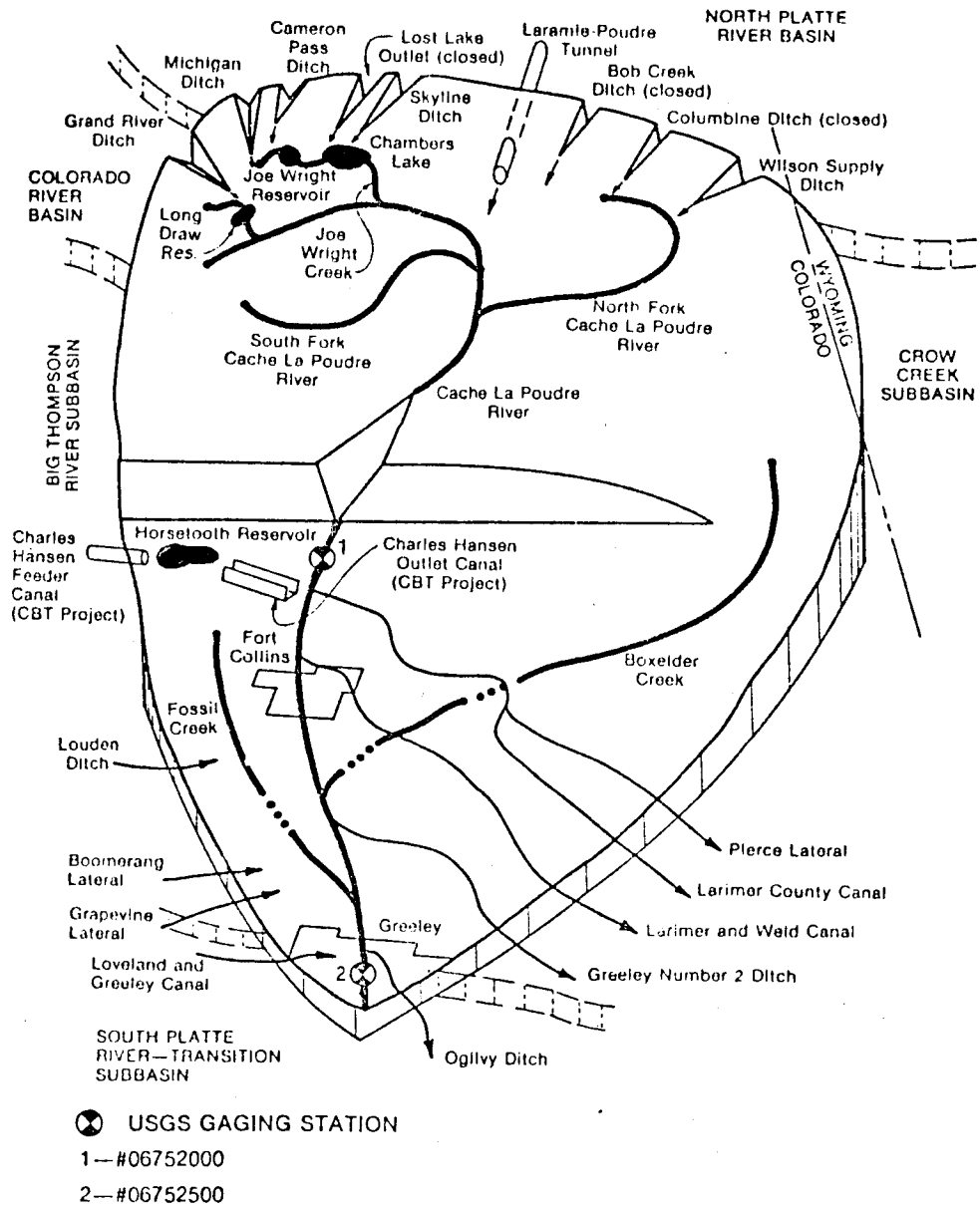

Figure 4-2. Schematic of the Cache la Poudre River Basin (Gerlek, 1977)



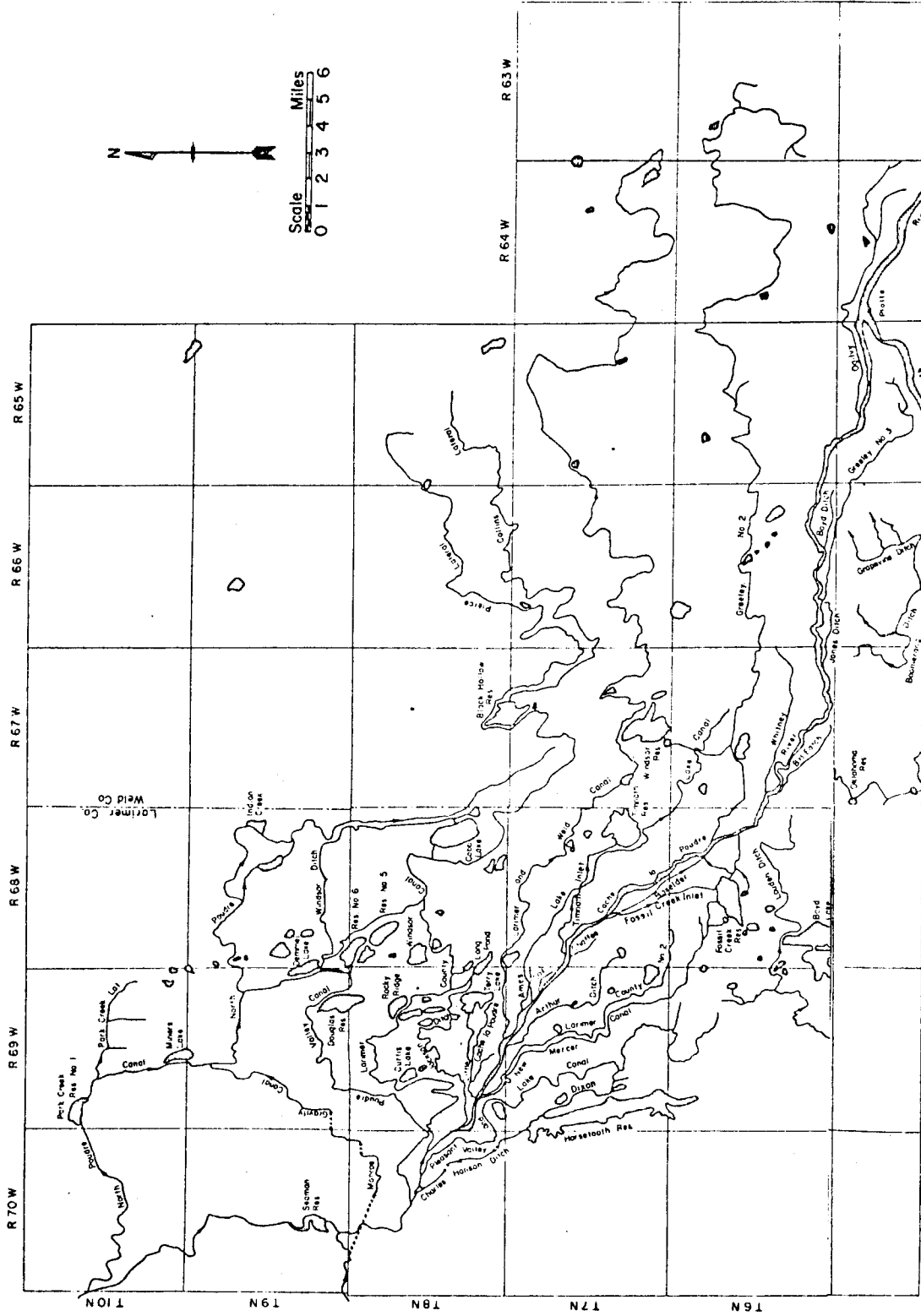

Figure 4-3. Map of Existing Canal and Reservoir System in the Cache la Poudre Valley (Evans, 1971)

and Woodward Governor in Fort Collins, the Great Western Sugar Beet Processing Plant in Greeley, and several fish hatcheries along the Poudre River near Rustic and Bellevue. The irrigated agriculture, the most attractive form of farming in the Poudre Valley is limited by the available water for irrigation. Nonirrigated lands are used for dry farming.

The distribution of the available native Cache la Poudre water in the valley is primarily ruled by water laws, based on the appropriation doctrine. The five main concepts of this doctrine are outlined in the following:

- (1) The principle "first in time, first in right" is applied when a water deficit at a certain time occurs. It imposes an order among the users, calling for a water allocation based on priority in time of the individual water rights.
- (2) The water in question must be the subject of a diversion. Although, instream uses of water have been established as legitimate with respect to water rights in recent years.
- (3) A beneficial use must be made of the water appropriated. The definition of beneficial use includes also the storage for a future beneficial use.
- (4) A valid appropriation of water is a right in real property. This right implies the right of a minimal streamflow at the point of diversion, to insure the fulfillment of the appropriation.
- (5) The appropriative right in water must exist for a definite amount, called the duty of water, normally expressed in cubic feet per second.

The appropriation doctrine, which is anchored also in the Colorado Constitution, applies to surface waters and to groundwaters. An appropriative right gives only the right to use the water beneficially and not to possess it for an indefinite time. Therefore, surplus water not consumptively lost during the use must be returned to the stream. Once a tributary water returns back to the stream, it is public again and can be recaptured by the original user only with another appropriation. It is obvious, under the existing law, that recycled reuse by a use system is only possible with two or more appropriations of native Cache la Poudre water. Appropriative water rights can be river direct flow rights over a certain amount of water per time unit for diversion. They can also be a reservoir decree, which permits the filling of a reservoir once each year. The total storage decrees in the Poudre Valley amounts to approximately 200,000 acre-feet.

The vehicle for administering the water rights in Colorado is provided by the Office of State Engineer, which controls the water attribution by means of water divisions and water districts. The Cache la Poudre Basin forms practically the Water District No. 3 which itself belongs to the Colorado Water Division No. 1. The daily water allocations are made by the water commissioners of the individual water districts.

Imported waters to the Cache la Poudre Basin are administered within the framework of interstate compacts and litigations. There are two basically different kinds of imported or "foreign" waters. One type is water imported through the Wilson Ditch, the Laramie-Poudre Tunnel, the Skyline Ditch, the Cameron Pass Ditch, the Michigan Ditch, and the Grand River Ditch. These waters are available for direct recycle

reuse in a use system, a significant difference to native Cache la Poudre water. Water imported through the USBR Big Thompson Project and administered by the Northern Colorado Water Conservancy District is not directly available for recycle reuse without another appropriation.

Irrigation companies divert, with a few exceptions, the water for agricultural purposes. Reitano (1978) states that these "company ownerships of water removes the restriction that a water right is appurtenant to a specific tract of land and allows the water to be moved between several parcels of land." Exchanges of water in the Poudre Valley may evolve from exchanges of water between stockholders within one irrigation company, from water exchanges between companies, and from exchanges of USBR Big Thompson Project water. Such exchanges are legitimized by law as long as the water rights of others are not injured. This constraint normally prevents the relocation of a point of diversion along the river.

#### 4.2 Fundamental Model Assumptions

As outlined in Section 3.1, Methodology, the first steps in constructing an input-output model is to determine the purpose of the analysis, to define the system boundaries, and to decide the time frame for the model. The goals of this investigation are to develop and exemplify a methodology of reuse modeling with the input-output approach. Therefore, the purpose of the practical model is to demonstrate the developed methodology for documentation of the status quo and for assessing possible future situations in a water resources system. This goal is slightly different to an actual case of systems analysis, which has to assume that the methodology of the chosen analysis approach is valid.

The system boundary of the water resources system "Cache la Poudre River Basin" is assumed to coincide with the boundary of the watershed of the Cache la Poudre River with a few exceptions. It is supposed, for the purpose of this investigation, that all of the lands irrigated by the Larimer County Canal, the Pierce Lateral, the Larimer and Weld Canal, the Greeley Canal No. 2, and the Ogilvy Ditch should belong to the system. Some of these lands are situated outside of the Poudre River watershed, but the water supply for the irrigation is totally dependent on the distribution of the waters flowing down the Poudre River. The Horsetooth Reservoir, as a part of the USBR Big Thompson Project, is considered to be outside of the Cache la Poudre River system. USBR Big Thompson water will enter the model system through the Charles Hansen Outlet Canal, and the diversion to the Spring Canyon Water and Sanitation District. The schematic of the Cache la Poudre River Basin (Figure 4-2) contains all of the mentioned elements which are subject to modifications to accommodate the Poudre watershed to the system used in the model. To establish the model in time, two time frames have been chosen. To investigate the potential of the methodology to model water reuse for documentary purposes, the water year 1979 has been selected. Data obtained during the investigations for constructing the model, mainly concerning municipal and industrial water consumptions, which were based on the calendar year 1979, have been assumed to be valid also for the water year 1979 without introducing a significant error.

To assess the planning potential of the developed approach, the year 2020 under assumed drought conditions has been selected. The choice of such a time span into the future enabled the investigator to impose

a large water demand by municipal use systems on the river basin assuming a continuation of the tremendous growth of population into the next century. The year 2020 is also convenient because it allows comparison of the results of this model with the results of a South Platte River study done by Hendricks et al., (1977). Assumptions concerning details during the workout of the matrix are explained in situ.

#### 4.3 The Elements of the Models

In the Cache la Poudre River Basin the elements of a reuse model are determined by the three sectors of use systems. These are the agricultural use systems, the municipal use systems, and the industrial use systems. In addition to these sectors providing the internal components of the matrix, a great variety of transbasin diversions into the Poudre Valley necessitates the extensive introduction of entry components. The exit components are the conventional ones, *Atmosphere*, *Storage*, and *Basin Outflow*, which also appeared in previous applications of the input-output matrix. In the following the entry components, the internal components, and the exit components are enumerated and shortly described individually.

##### 4.3.1 Entry Components.

CLP, Native Flow: The "Cache la Poudre, native flow" component comprises all the runoff through the Poudre River streambed without the return flows from use systems and without imported waters. These native flow waters, mainly spring runoff of the snowmelt, are of high quality and often called "primary" waters.

Wilson Ditch: The Wilson Ditch imports water from the Laramie River Basin into the north fork of the Cache la Poudre River. It is owned by the Divide Reservoir and Supply Company.

Laramie-Poudre Tunnel: This tunnel imports water from the Laramie River Basin into the Poudre drainage. It is owned two-thirds by the Water Supply and Storage Company and one-third by the Windsor Reservoir Company.

Skyline Ditch: The Skyline Ditch imports water from the Laramie River Basin into the Poudre River. It is owned by the Water Supply and Storage Company.

Cameron Pass Ditch: The Cameron Pass Ditch imports water from the North Platte River Basin into the Poudre drainage. It is owned by the Water Supply and Storage Company.

Michigan Ditch: The Michigan Ditch imports water from the Colorado River Basin into the Cache la Poudre Basin. It is owned by the City of Fort Collins.

Grand River Ditch: The Grand River Ditch imports water from the Colorado River Basin into the Cache la Poudre Basin. It is owned by the Water Supply and Storage Company.

Colorado Big Thompson: The USBR Colorado Big Thompson Project imports water into the Poudre Drainage via the Charles Hansen Outlet Canal and the Dixon Feeder Canal, both draining the Horsetooth Reservoir.

Big Thompson, Native Flow: The component "Big Thompson River, Native Flow" allows for accounting of the agricultural return flows from parts of the Loudon Ditch, the Boomerang Lateral, and the Grapevine Lateral. These ditches are fed by native Big Thompson River water.

Groundwater: The groundwater component comprises water of the Poudre Valley aquifer, which has not infiltrated into the ground during the modeled time frame.

Carry-Over Storage: This component accounts for inputs into the Cache la Poudre River from reservoir storage carried over from previous time periods. The amount carried over is determined by an analysis of the actual water volume in each reservoir at the beginning and at the end of the time period considered.

Others: This component comprises all additional controllable water inputs into the Cache la Poudre River Basin not included in other entry components.

One should note that the precipitation falling on the Poudre drainage is not included into the entry components as far as it is not running off through the Poudre River. This is due to the fact that the water input by precipitation, which does lead to runoff, is uncontrollable and therefore not redistributable.

#### 4.3.2 Internal Components, Use Systems.

##### Municipal Sector

*Northern Colorado Water Association:* The Northern Colorado Water Association serves about 500 domestic taps north of Fort Collins. The water is supplied by three groundwater wells.

*Fort Collins:* The City of Fort Collins is supplied by water from the Cache la Poudre River and from the Horsetooth Reservoir.

Fort Collins supplies water to water districts and minor industries. The City is the origin for an existing reuse scheme, providing its sewage treatment plant effluent for sequential agricultural reuse via Fossil Creek Reservoir. A future reuse scheme



and water exchange will also supply the Rawhide Power Plant north of Fort Collins with treated wastewater for cooling purposes.

*Spring Canyon Water District:* The Spring Canyon Water and Sanitation District west of Horsetooth Reservoir is directly supplied with Colorado-Big Thompson Project Water from the Charles Hansen Feeder Canal.

*West Fort Collins Water District:* The West Fort Collins Water District is supplied by treated water from the Poudre Valley Pipeline owned by the City of Fort Collins. It serves about 750 domestic taps.

*East Larimer County Water District:* This water district, east of Fort Collins, is supplied by the Soldier Canyon treatment plant using water from Horsetooth Reservoir. In 1979 it was partially supplied by the La Porte treatment plant owned by Fort Collins because of a temporary shutdown of the Soldier Canyon treatment plant.

*Fort Collins-Loveland Water District:* This water district, between Fort Collins and Loveland, is supplied the same way as the East Larimer County Water District.

*North Weld County Water District:* This water district, northeast of Fort Collins, is supplied the same way as the East Larimer County Water District.

*Windsor:* The town of Windsor has been supplied until 1979 by the City of Greeley. From 1980 on this town is supplied by the Fort Collins-Loveland Water District.

*Rural Users:* The component "rural users" consists of all domestic supplies not covered by the other municipal use systems. It also includes users who pump groundwater for domestic purposes.

*Greeley:* Today, the City of Greeley is mainly supplied by Cache la Poudre River water, but the town is also able to treat Big Thompson native water or Colorado-Big Thompson Project water. The town supplies several water districts contained in the use system "rural users" and some major industries in the area.

#### Industrial Sector

*Rustic Fish Hatchery:* The fish rearing unit in Rustic is supplied with Cache la Poudre River water. After use with neglectable consumptive losses, the water is returned to the river.

*Bellevue Fish Hatchery:* The fish hatchery at Bellevue pumps groundwater for its supply. After use with neglectable consumptive losses, the water is diverted to the Watson fish rearing unit.

*Watson Fish Hatchery:* The Watson fish rearing unit is partially supplied by the outflow from the Bellevue Fish Hatchery and by Poudre River water. After use, all the water is returned to the river.

*Rawhide Power Plant:* The Rawhide Power Plant, north of Fort Collins, will start its operation in the mid 1980's. By the year 2020, all three projected power generating units are assumed to be operational. For the cooling water supply, an exchange-reuse agreement with Fort Collins, the Water Supply and Storage Company, and the Platte River Power Authority, which will be operating the power plant, has been enacted.

*Eastman Kodak:* The Eastman Kodak manufacturing plant near Windsor is supplied by the City of Greeley.

*Monfort:* The Monfort Meatpacking Plant in Greeley has been supplied by the City of Greeley. Towards the end of 1979, the plant stopped production.

*Great Western Greeley:* The Great Western Sugar Beet Processing Plant in Greeley is partially supplied by the City of Greeley and partially by Cache la Poudre River water. An additional water input to the factory is a significant humidity of the beets.

Although there are additional major industries in the Cache la Poudre Basin, their impact on water consumption and water reuse is assumed not to be significant.

#### Agricultural Sector

To grasp the situation in the agricultural sector, the irrigation and canal companies are assumed to be valid representatives of the agricultural areas to which they supply the water. Hence, instead of agricultural lands, the irrigation companies are introduced as the use systems for this sector. This is advantageous, concerning possible redistribution of water insofar as the canal companies' stockholders are the owner of the water rights. A water right is never attributed to a specific agricultural area. The following agricultural use systems are introduced as internal components:

*North Poudre Irrigation Company*

*Cache la Poudre Irrigation Company*

*Pleasant Valley and Lake Canal Company*

*Other Irrigation Companies above Fort Collins\**

*Windsor Reservoir and Canal Company*

*Water Supply and Storage Company*

*Larimer and Weld Irrigation Company*

---

\*This aggregated component consists of the companies for the Dixon Canal, the Arthur Ditch, the Larimer County Canal No. 2, the New Mercer Canal, Jackson Ditch, and for the Coy Canal.

*Larimer County Underground Water Users Association*

*Lake Canal Company*

*Cache la Poudre Reservoir Company*

*New Cache la Poudre Canal Company*

*Greeley No. 3 Canal Company*

*Other Irrigation Companies below Fort Collins\**

*Weld County Underground Water Users Association*

*Ogilvy Ditch Company*

The reader will notice that some of the irrigation companies are considered "above" Fort Collins and some "below." "Above" means the irrigation companies such as the North Poudre Irrigation Company, the Cache la Poudre Irrigation Company, the Pleasant Valley and Lake Canal Company, and the Other Irrigation Companies above Fort Collins, which supply lands situated at the same or higher elevations than the elevation of the City of Fort Collins. The rest of the irrigation companies are considered "below" Fort Collins even though currently they have points of diversion upstream from Fort Collins. These irrigation companies are potential partners for water exchanges with the City of Fort Collins, by giving Fort Collins the right to use the irrigation companies' water first and then return the water to these companies for sequential reuse.

#### 4.3.3 Exit Components.

Atmosphere: Water input to this exit component is water lost by consumptive uses.

---

\* This component consists of the companies for the Chaffee Ditch, the Boxelder Ditch, the Whitney Ditch, the B. H. Eaton Ditch, the Jones Ditch, and for the Boyd Ditch.

Storage: Water origin for this exit component is water diverted by the irrigation companies to reservoirs and carried over to future time periods.

Basin Outflow: This component contains all streams of water leaving the Cache la Poudre Basin on the surface. Subsurface outflows through aquifers are neglected.

4.3.4 Return Flow Component, Because of the occurrence of agricultural return flows in the basin, the introduction of the dummy transfer component "return flow" is necessary according to the outlined principles in Section 3.2.

#### 4.4 The 1979 Reuse Models

The potential for documentation of the methodology to model water reuse with the input-output matrix is assessed by modeling the conditions of the water year 1979. Both Schemes I and II, as explained in Section 3.1, have been adopted and the results displayed on a magnetic board.

4.4.1 The 1979 Reuse Model - Scheme I, Scheme I is based mainly on the type of water uses and reuses in the water resources system. The display of this model is shown in Figure 4-4, and the documentation of the data is given by the water balance diagrams in Appendix A. In the display for the model Scheme I, the labels, which represent the use systems on both the output rows and the input columns, are color coded according to the sector they are belonging to.

COLOR	SECTOR
Light Blue	Municipal
Orange	Industrial
Brown	Agricultural

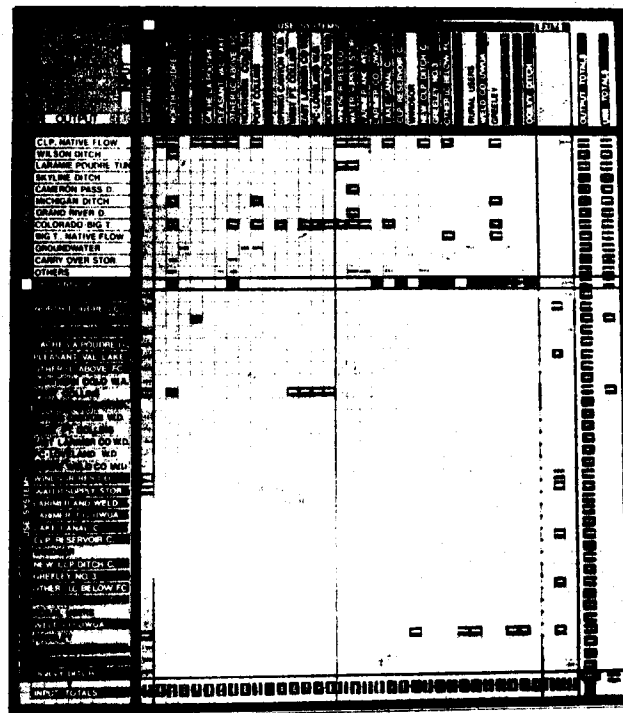

Figure 4-4. The 1979 Reuse Model - Scheme I

The dummy transfer component is the white on black label "return flow." The colors underlying the data for the water inputs to use systems are coded according to the form of water use and reuse, which they represent. Of the four colors provided by Scheme I for the various types of water uses and reuses, only three show up in the matrix for the 1979 conditions. The red color, indicating "recycle reuse," does not show up. This fact is understandable because this form of reuse is largely prevented by the existing water laws.

The dark green color of the labels designating the inputs of Fort Collins, the Windsor Reservoir and Canal Company, the Water Supply and Storage Company, and Greeley to the component "return flow" indicates that portions of these return flows are theoretically available for recycle reuse. Which portions of these return flows are available will have to be decided by court for each specific case due to the fact that the existing water laws are not explicit about the problem. The light green color on the matrix shows the occurrence of sequential reusable water.

The matrix modeled with Scheme I verifies the current reuse status in the Cache la Poudre River system. Sequential reuse, indicated by orange data labels, is mainly employed to irrigate lower portions of the Poudre Valley by diverting return flows to the Poudre River.

Remarkable is the large portion of Cache la Poudre native flow water, i.e., high quality primary water, which has been used to irrigate lower areas of the Poudre Valley. This is due to the fact that the water year 1979 was extremely wet, therefore, more primary water was made available to downstream users. The amount of CLP native flow water diverted by all the irrigation companies below Fort Collins has

been 123,568 acre-feet. Some of this amount could be made available for future increased demands of the City of Fort Collins by exchange and water reuse agreements. Some of these waters would be first used by the City of Fort Collins and after treatment sequentially reused by the irrigation companies. Initial steps to such reuse schemes are already visible insofar as the effluents of the Fort Collins Sewage Treatment Plant No. 2 are directly released to the Fossil Creek Reservoir Inlet Canal owned by the North Poudre Irrigation Company for agricultural reuse.

Waters leaving the system in space or time are color coded if they have a use potential. The water inputs to storage are coded dark blue under the assumption that the reservoirs are filled in spring with high quality primary water. Waters leaving the basin are marked light green, indicating that they are available for reuse in the Cache la Poudre system, for instance, by pumping them back upstream.

Additional information is given in the constructed models by the data marked with brackets in the matrix cell. The brackets indicate that the use system in the function of an origin acts only as a water transfer unit and not as an actual use system. The introduction of these data points to important interrelationships within the system.

4.4.2 The 1979 Reuse Model - Scheme II. The main difference to Scheme I is that the water quality of the used water is color coded according to the methods explained in Section 3.1. Therefore, the labels for the use systems on the input columns are no longer colored according to sector differentiations but according to minimal quality requirements measured in "total dissolved solids." In Scheme II, the position of the data and the water quality give an indication for reused water.



As in Scheme I, the large amount of high quality water used by the irrigation companies below Fort Collins, partially because of the hydrological conditions, shows up well (see Figure 4-5). Another fact, confirmed by the analysis of water quality measurements of supplies to rural domestic users, is the low quality of the water inputs to these users shown on the matrix. Out of the 5,000 acre-feet consumed by rural domestic users, 2,400 acre-feet are of very low quality (TDS is between 1,500 and 3,000 mg/l) indicated by the yellow color of the return flow input to "rural users." The increasing total dissolved solids content downstream of the Cache la Poudre River is indicated by the change of the data label color from green to yellow in the column and row for the transfer component "return flow." The water quality to the individual water transfers has been assigned using the information provided by Bluestein and Hendricks (1975).

For both schemes, a water use index,  $w_i$ , has been defined to link the total water uses in the Cache la Poudre Basin with the total water inputs into the water resources system. It is defined as:

$$w_i = \frac{\sum(\text{total uses})}{\sum(\text{output totals of entry components})}$$

For the water year 1979, as displayed on the matrix,  $w_i$  is:

$$\begin{aligned} w_i &= \frac{577,354 \text{ acre-feet}}{577,319 \text{ acre-feet}} \\ &= 1.00 \end{aligned}$$

The value of 1.00 for the water use index suggests that every water unit put into the Cache la Poudre system has been used exactly once. In reality, some reuse had to occur due to the fact that 160,762 acre-feet



of the total input to the basin are leaving the system unused by the exit component "basin outflow,"

#### 4.5 The 2020 Reuse Model

The planning potential of the input-output reuse model is evaluated by defining a scenario for a set of conditions possibly ruling the water resources system of the Cache la Poudre in the future. The time frame has been chosen to be the water year 2020. The following scenario assumption set has been defined as boundary conditions for the 2020 water demand projections. It is based on the data projected for the year 2020 in the study by Hendricks et al., (1977).

4.5.1 Municipal Sector. To project the water demands of the municipal sector, the demand factor "population" is assumed to follow high series as outlined by Hendricks et al., (1977). The average per capita use is assumed to be 190 gallons per day. Based on these assumptions, the projected populations and water demands for the municipal use systems are given in Table 4-2.

4.5.2 Industrial Sector. It is assumed that the water demands for the industrial sector remain stable on the niveau of the year 1979 based on the following considerations:

- The population growth in the Poudre River Basin is probably not tied to the development of heavy industries,
- The Poudre Valley seems to be developing with further growth founded on technological industries,
- These technological industries are likely to use municipal water.
- Self-supplied industrial water demands remain constant based on a balance between increase in-house water demands and better water conservation.

Table 4-1. Projected Water Demands of the Municipal Sector for the Year 2020

Use System	Population	Per Capita Use gallons/day	Water Demand in 2020 acre-feet/year
Northern Colorado Water Association	2,312	190	492 <sup>b</sup>
Fort Collins	160,000 <sup>c</sup>	190	34,052
Spring Canyon Water District	498	190	106 <sup>b</sup>
West Fort Collins Water District	2,871	190	611 <sup>b</sup>
East Larimer County Water District	13,180	190	2,805 <sup>b</sup>
Fort Collins-Loveland Water District	13,654	190	2,906 <sup>a</sup>
North Weld County Water District	16,342	190	3,478 <sup>b</sup>
Windsor	3,125	190	665 <sup>b</sup>
Rural Users	38,844	190	8,267 <sup>b</sup>
Greeley	93,800	190	19,962

<sup>a</sup>Total water demand of Fort Collins-Loveland Water District including Windsor's 3,571 acre-feet/year.

<sup>b</sup>Water demand projected by using the trend for "others transition" as defined in the study by Hendricks et al., (1977). The starting year for the projections is 1979.

<sup>c</sup>Projected by the City of Fort Collins.

The projected Rawhide Power Plant will be an additional industrial water user in the year 2020. It is assumed to be fully built. The Monfort Meatpacking Plant, which has been shut down since the end of 1979, is assumed to remain closed. Table 4-3 gives the projected water demands for the industrial sector.

4.5.3 Agricultural Sector. It is assumed that the decrease in irrigated acreage in the Poudre Valley follows the general trend given by Hendricks et al., (1977) for the South Platte River Basin. Between 1980 and 2020, the decrease will be about ten percent due to urban encroachment. The irrigation efficiency up to the year 2020 will remain constant to guarantee sufficient return flows for downstream appropriators. Therefore, it can be assumed that the water demands by the agricultural sector decrease also by ten percent. Table 4-4 gives the projected water demands for the agricultural use systems.

4.5.4 Hydrological Conditions, Water Entries. For the water year 2020 drought conditions are assumed in the Cache la Poudre River Basin. It is assumed that the native flow of the Cache la Poudre is 158,060 acre-feet for that year. This flow equals the average runoff per year during the 1953 through 1956 four-year drought period.

Further, it is assumed that no carry-over storage is available. The inputs by the transbasin structures, except the USBR Big Thompson Project, should provide an average yield. In addition, it is assumed that Colorado Big Thompson Project water can be made available to cover occurring deficits. The Windy Gap Project, which is postulated today, is assumed not to be in operation. Table 4-5 lists all of the important water inputs to the basin.

#### 4.6 The 2020 Reuse Matrix "Drought"

The 2020 reuse matrix as displayed in Figures 4-6 and 4-7 is based on Scheme I pointing to the various water use and reuse forms, which occur

Table 4-2. Projected Water Demands of the Industrial Sector for the Year 2020

Use System	Water Demand in 2020 acre-feet/year
Rustic Fish Hatchery	4,256
Bellevue Fish Hatchery	1,452
Watson Fish Hatchery	4,356
Rawhide Power Plant	12,600 (3 units of 4,200 acre-feet each)
Eastman Kodak	1,123
Monfort	0 (closed since 1979)
Great Western of Greeley	1,777

Table 4-3. Project Water Demands of the Agricultural Sector for the  
Year 2020

Use System	Water Demand in 2020 acre-feet/year
North Poudre Irrigation Company	85,824
Cache la Poudre Irrigation Company	10,911
Pleasant Valley/Lake	11,511
Other Irrigation Companies above Fort Collins	18,717
Windsor Reservoir and Canal Company	31,547
Water Supply and Storage Company	71,844
Larimer and Weld Irrigation Company	82,035
Larimer County UWUA	24,209
Lake Canal Company	10,452
CLP Reservoir Company	8,920
New Cache la Poudre	32,027
Greeley No. 3	10,765
Other Irrigation Companies below Fort Collins	24,852
Weld County UWUA	22,556
Ogilvy Ditch	15,267

Table 4-4. Assumed Water Inputs into the Cache la Poudre River Basin for  
for the Year 2020 for Drought Conditions

Entry Component	Input in 2020 acre-feet/year
CLP, Native Flow	158,060
Wilson Ditch	2,383
Laramie-Poudre Tunnel	15,630
Skyline Ditch	1,707
Cameron Pass Ditch	107
Michigan Ditch	4,800 <sup>a</sup>
Grand River Ditch	21,513
Colorado-Big Thompson	variable
Carry-Over Storage	0

<sup>a</sup>projected average yield by the city of Fort Collins







during the considered time frame. Figure 4-6 shows the situation likely to exist in the year 2020 if it is assumed that the agricultural sector owns rights for the same amount of Colorado-Big Thompson Project water as in the year 1979. Because of the assumption that the municipal and industrial sectors will have the financial and political power to assure enough primary water to meet the increased demands in the year 2020, some irrigation companies below Fort Collins (Windsor Reservoir Company, Water Supply and Storage Company, Larimer and Weld Irrigation Company, Lake Canal Company) are forced to cover an increased portion of their water needs by return flows of the Cache la Poudre River. This fact, in addition to the drought conditions, increases the demand for return flows drastically to 247,087 acre-feet for the water year 2020. This is an increase of 93,028 acre-feet compared to 1979. On the other hand, inputs to the component "return flow" based on the projected demands and the consumptive losses of the use system are projected to be totally only 174,584 acre-feet. Therefore, a deficit of 72,503 acre-feet will exist between the input to the component "return flow" and the output needed from this component. This deficit, which has to be reduced to zero for a balanced input-output matrix, can be offset either by introducing more foreign water or by reducing the demands of the agricultural sector. This reduction would have to be more than the deficit because such a reduction would also lessen the available return flows from agriculture. Figure 4-7 shows a model in which imports of Colorado-Big Thompson Project water will be increased beyond the 1979 level to counter balance the deficit.

Three reuse schemes, in addition to the sequential reuses of return flows from the "return flow" component by agriculture, will be in effect. They are the sequential reuse of water used first in the Bellevue Fish

Hatchery and second, in the Watson fish rearing unit; the sequential reuse of treated Fort Collins' wastewater by the North Poudre Irrigation Company; and the reuse and water exchange scheme between Fort Collins and the Rawhide Power Plant.

To obtain, as for the 1979 model, an idea about how many times in the average a water unit will be used, the water use index,  $w_i$ , for the balanced 2020 matrix is:

$$w_i = \frac{572,083 \text{ acre-feet}}{374,004 \text{ acre-feet}}$$

$$= 1.53$$

#### 4.7 Disclosures of the Reuse Models

4.7.1. The 1979 Models. Although the water year 1979 is considered to be a wet year, both matrices, Scheme I and Scheme II, make evident that the water is not distributed and used in an efficient way today. This is due to the fact that the water resources development in the basin has been evolving over the years in steps. There was never an attempt to "optimize" the overall system.

The input-output reuse matrices for 1979 show that a big portion of high quality primary water is used for purposes requiring only a lower quality. Based on tradition, agriculture gets the high quality water and the municipal sector has to seek additional water either by improving foreign water import possibilities or by purchasing water rights. Fort Collins, for example, has been improving its Michigan Ditch and Joe Wright Reservoir system to "create" more foreign water. The arrangement of the use systems on the matrix points out that there is a potential for water exchanges between the agricultural sector and the municipal sector. All agricultural use systems on the right side of the red line on the matrix, which receive primary, high quality water, could enter

an exchange agreement with the municipal use systems on the left side of the red line. Such agreements would allow the domestic suppliers to use first the primary water, which is today directly appropriated to these agricultural use systems. The return flows of the municipal use sector, including makeup water to offset domestic consumptive losses, would then be diverted for planned sequential reuse to irrigators below the domestic users. One drawback of such agreements is that certain parts of the agricultural distribution system would have to be relocated. Also points of diversion would have to be changed, possibly involving legal struggles. The matrices point to the potential spots for such reuse agreements and designate the use systems involved, which would have to negotiate such an agreement.

4.7.2 The 2020 Reuse Model. The 2020 matrix displays a possible solution to cover the water needs of the municipal sector in the future. The primary water appropriated to agricultural use systems below Fort Collins is drastically reduced by increasing the use of return flows from the municipal sector.

The model shows that a deficit in the system can only be avoided by importing more foreign water than in the year 1979. There is no possibility for a further increase of water reuse because the total basin outflow is practically neglectable in the model. This indicates that nearly all the inputs of water into the Cache la Poudre River Basin are consumptively used. The displayed solution arouses doubts concerning the water quality in such a highly managed water resources system.

An interesting fact is that the sum of total uses in 1979 of 577,354 acre-feet and in 2020 of 572,083 acre-feet is about the same, indicating

that the increase in water demands by municipalities is offset by the projected decrease in water needs by agriculture. On the other hand, it is also a signal that already today large deficits in the Cache la Poudre Basin can occur under severe drought conditions. Table 4-5 compares the water demand and supply situation in the Cache la Poudre River Basin for the two modeled years.

Table 4-5. Water Demands, Water Supply and Demand Coverage for the Modeled Years 1979 and 2020

Water Year	1979 (acre-feet)	2020 (acre-feet)
<u>Water Demands</u>		
Municipal Sector	47,877 <sup>a</sup>	84,082 <sup>a</sup>
Industrial Sector	17,053	25,664
Agricultural Sector	<u>512,424</u>	<u>462,337</u>
Total Demand	577,354	572,083
<u>Water Supply</u>		
Native Water	470,888	173,387
Foreign Water	<u>106,431</u>	<u>200,617</u>
Total Supply	577,319	374,004
<u>Demand Coverage</u> (in percentage of the sector's water demand)		
Municipal Sectors		
Primary Water	93	95
Reused Water	7	5
Industrial Sector		
Primary Water	75	40
Reused Water	25	60
Agricultural Sector		
Primary Water	70	46
Reused Water	30	54

<sup>a</sup>This value includes the groundwater infiltration into the municipal sewer systems (5,292 acre-feet for 1979; 10,738 acre-feet for 2020).

## CHAPTER V

### CONCLUSIONS AND RECOMMENDATIONS

#### 5.1 Conclusions

The input-output model has a utility as a tool to analyze water reuse. Its usefulness stems from the ability to organize and collate large amounts of complex data into an organized and understandable format. The reuse input-output matrix is a further development of the water transaction tables of past applications of the input-output model. The methodology exposed in this work is suitable for developing concepts for improving water resources systems. It is particularly valuable for systems, in which water augmentation by means of reusing water is a valid alternative.

The water reuse input-output model is well adapted for use in the three stages of documentation, planning, and implementation, which occur during the development of a water resources system. Documentation of existing situations is essential to assess the response of the considered system on actions taken in the past. The assessment of this response is needed to eliminate unfeasible alternatives, which are proposed for future developments. A reuse input-output model, which displays a status quo of the system is able to support such an assessment because of its attractive and comprehensive display of all important features.

The final solution at the beginning of the planning stage is wide open. The input-output reuse model is a source of basic information to create water development alternatives. The model helps to identify the range of possible final solutions. The way the reuse matrix conceptualizes the system provides a "blue print" (Bishop, 1975) for constructing analytical, mathematical, or simulation models for the system.



The matrix perfectly supports the evaluation of the alternatives by its ease of implementing and displaying the options. All changes on the matrix are immediately reflected throughout the entire system due to the mass balance requirements, which state that the sum of the inputs has to be equal to the sum of the outputs. The mass balance requirements guarantee also that the data for constructing the matrix are collected in a consistent manner.

The reuse input-output matrix is always predictive, stating "what will be" under certain conditions. It can never be prescriptive, telling the decision maker "what to do" under certain assumptions.

By the models "macroview" of a water resources system, the analyst is enabled to recognize the presence of reuse potential. Subsequently, situations within the system with reuse potential can be "optimized" with more sophistication, but also more constrained means of systems analysis.

The reuse matrix provides a forum for the decision maker to explore the opinions of other involved parties. Bruvold and Crook (1979) state:

"Few voters are expert enough to develop and assess options, but they may well be able to understand the options and option analyses developed by the technical experts, when the information is presented in laymen's language."

The reuse input-output model is a valid support for indoctrination during the stage of implementation of a chosen course of action. This support is based on the model's easily understandable way of depicting the projected futures. An understanding of the benefits of planned futures is essential to gain the promotion of all parties involved. This promotion helps to avoid the situation described by Okun (1975):

"We are keen to make models of river basin systems in the United States; but these are exercises in futility because they cannot be implemented."

## 5.2 Recommendations

The present concepts of reuse modeling with the input-output matrix have to be refined in the direction of an "optimal" integration of the reuse model into the overall systems analysis process. The main focal point of further research must be an improvement of the understanding of the transition from the "macro" modeling of the water resources system with the input-output matrix to the more refined "micro" analysis of identified interesting aspects within the system. Requirements for an efficient transition will probably determine the choice of the use systems and the overall systems aggregation for the input-output model. Efforts should be directed to assess the impact of nonpoint return flows, for example, from agricultural irrigation on reuse schemes and on the reuse model.

## REFERENCES

- Bengoechea, V., "Input-Output Modeling of the Water System of the City of Fort Collins," Environmental Engineering Technical Report, Department of Civil Engineering, Colorado State University, Fort Collins, Colorado, May, 1979.
- Benson, R., Loudon Ditch Company, Loveland, Colorado, Personal Conversation, 1980.
- Bishop, B., "Systems Analysis," Chapter 10 in Environmental Design for Public Projects, by Hendricks, D. W., Vlachos, E. C., Tucker, L. S., and Kellogg, J.C., Water Resources Publications, Fort Collins, Colorado, 1975.
- Bluestein, M. H. and Hendricks, D. W., "Biota and Water Quality of the South Platte River, Past-Present-Projected," Environmental Engineering Technical Report, Department of Civil Engineering, Colorado State University, Fort Collins, Colorado, December 1975.
- Brenton, R. C., Director of Environmental Affairs, Great Western Sugar Company, Denver, Personal Correspondence, 1980.
- Bruvold, W. H. and Crook, J., "Gaining Public Acceptance," Consulting Engineer, Volume 53, September 1979.
- Chapman, M., Administrator, Monfort Meatpacking Plant, Greeley, Colorado, Personal Conversation, 1980.
- Dannels, P., Manager of the Spring Canyon Water Treatment Plant, Fort Collins, Colorado, Personal Conversation, 1980.
- De Haan, R. W., "An Input-Output Analysis of the Total Water System in a River Basin," M.S. Thesis, Department of Civil Engineering, Colorado State University, Fort Collins, Colorado 1976.
- Evans, R., "Hydrologic Budget of the Poudre Valley," M.S. Thesis, Department of Civil Engineering, Colorado State University, Fort Collins, Colorado, 1971.
- Fort Collins, City of, Records of the Water and Sewer Department, 1980.
- Gerlek, S., "Water Supply Analysis, South Platte River Basin 1970- 2020," Volume II of Water Supply Management Analysis and Alternative Development for the South Platte River Basin, Seven Volumes, U.S. Army Corps of Engineers, Omaha District, Omaha, Nebraska, April 1977.
- Greeley, City of, "Annual Report 1979" of Water and Sewer Department, 1979.
- Hall, W. A. and Dracup, J. A., "Water Resources Systems Engineering," New York: McGraw-Hill Book Company, 1970.

- Hendricks, D. W. and De Haan, R. W., "Input-Output Modeling in Water Resources System Planning," Environmental Engineering Technical Report, Department of Civil Engineering, Colorado State University, Fort Collins, Colorado, November 1975.
- Hendricks, D. W., Janonis, B. A., Gerlek, S., Goldbach, J., and Patterson, J. L., "Water Supply-Demand Analysis South Platte Basin, 1970-2020," Volume I of Water Supply Management Analysis and Alternative Development for the South Platte River Basin, Seven Volumes, U.S. Army Corps of Engineers, Omaha District, Omaha, Nebraska, 1977.
- Hendricks, D. W. and De Haan, R. W., "Input-Output Modeling in Water Resources System Planning," Environmental Engineering Technical Report, Department of Civil Engineering, Colorado State University, Fort Collins, Colorado, November 1975.
- Leontief, W. W., "Input-Output Economics," Scientific American, Volume 185, No. 4., pp. 15-21, October 1951.
- Liebmann, H., "Der Wassergüteatlas," R. Oldenburg, München, 1969.
- March, J. G. and Simon, H. A., "Organizations," New York: John Wiley and Sons, Inc., 1966.
- Neutze, J., Water Commissioner for the Cache la Poudre River Basin, Fort Collins, Personal Conversation, 1980.
- Okun, D. A., "A Potential for Water Reuse - Dual Supplies," Proceedings: AWWA Seminar on Reuse, Minneapolis, June 8, 1975.
- Patterson, J. L., "Industrial Water Demands 1970-2020," Volume IV of Water Supply Management Analysis and Alternative Development for the South Platte River Basin, Seven Volumes, U.S. Army Corps of Engineers, Omaha District, Omaha, Nebraska, April 1977.
- Reitano, B. M. and Hendricks, D. W., "Input-Output Modeling of the Cache la Poudre River System," Environmental Engineering Technical Report, Department of Civil Engineering, Colorado State University, Fort Collins, Colorado, May 1979.
- Skogerboe, G. V., Radosevich, G. E., and Vlachos, E. C., "Consolidation of Irrigation Systems," Phase I, Environmental Resources Center, Colorado State University, Fort Collins, Colorado, 1973.
- Turner, C. D., "Water Reuse Potential in the South Platte River Basin," Ph.D. Dissertation, Department of Civil Engineering, Colorado State University, Fort Collins, Colorado, 1981.

APPENDICES

APPENDIX A

WATER BALANCE DIAGRAMS  
FOR THE YEAR 1979

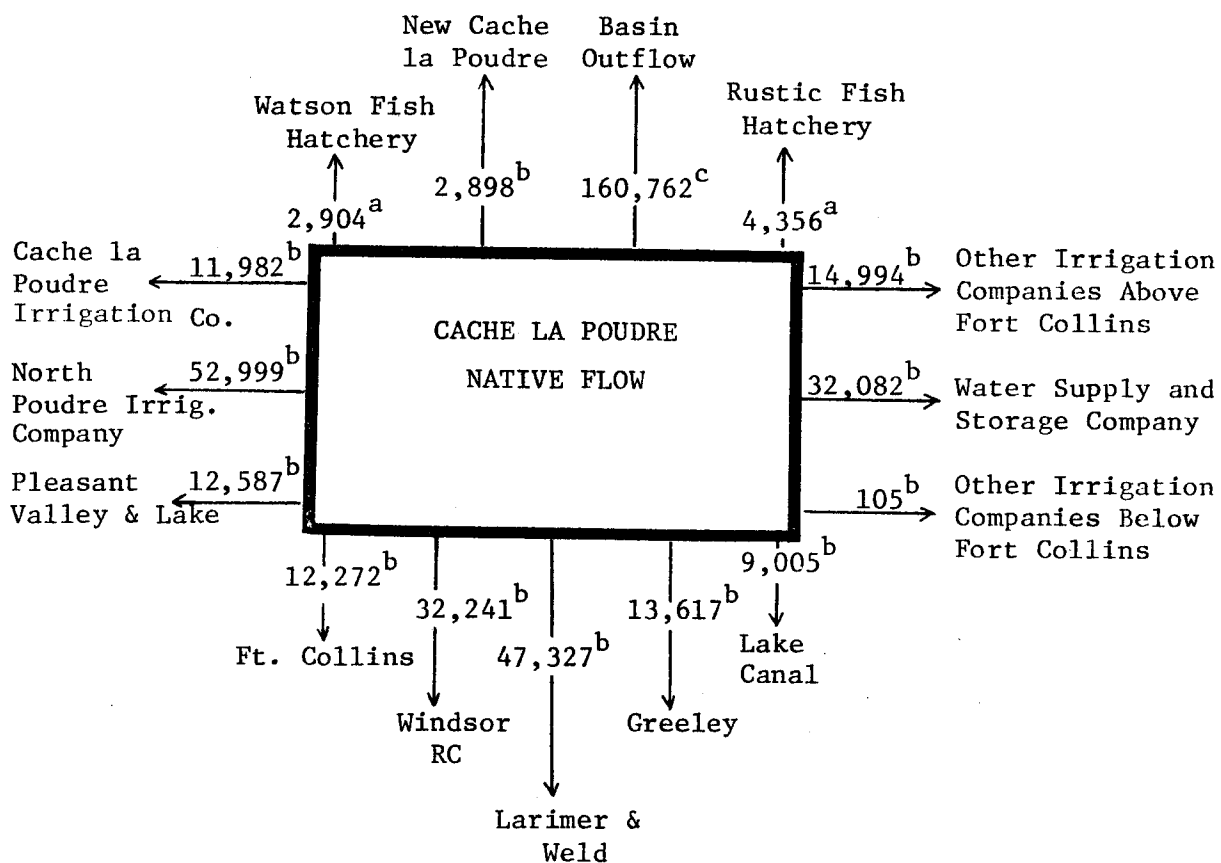

<sup>a</sup>Patterson (1977)

<sup>b</sup>See Table B-1

<sup>c</sup>Neutze (1980)

A-1. Water Volumes Originated from Cache la Poudre, Native Flow

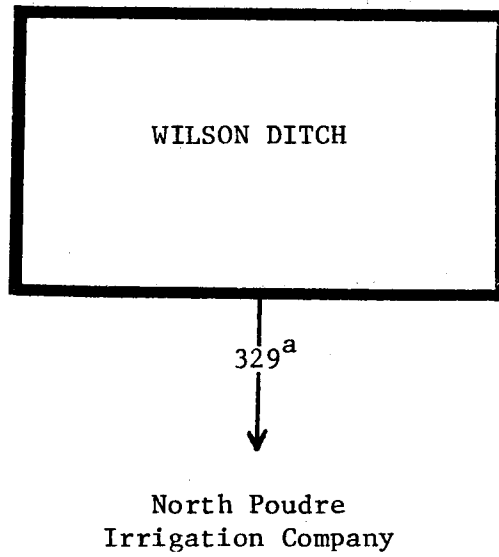

<sup>a</sup>Neutze (1980)

A-2. Water Volumes Originated from Wilson Ditch



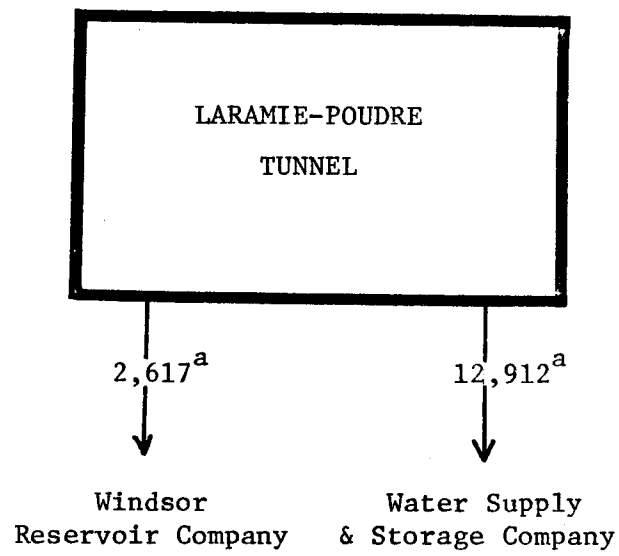

<sup>a</sup>Neutze (1980)

A-3. Water Volumes Originated from Laramie-Poudre Tunnel

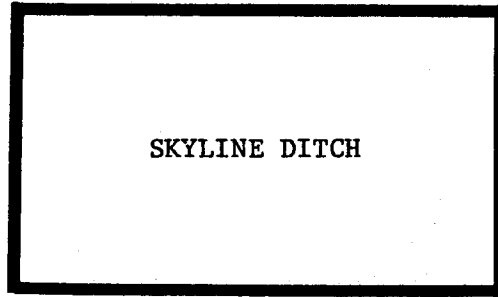

No Water Imports in 1979

A-4. Water Volumes Originated from Skyline Ditch

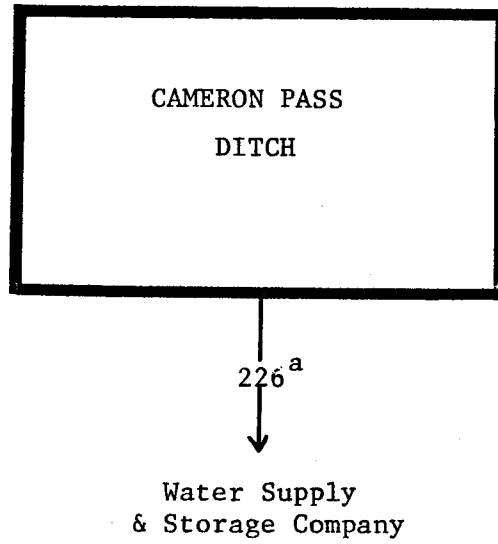

<sup>a</sup>Neutze (1980)

A-5. Water Volumes Originated from Cameron Pass Ditch

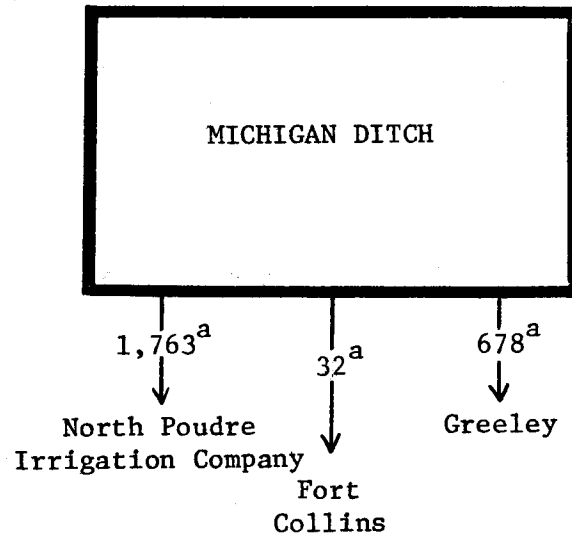

<sup>a</sup>Neutze (1980)

A-6. Water Volumes Originated from Michigan Ditch

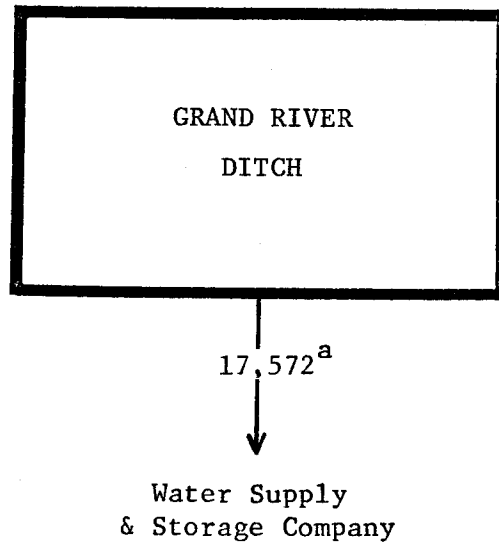

<sup>a</sup>Neutze (1980)

A-7. Water Volumes Originated from Grand River Ditch

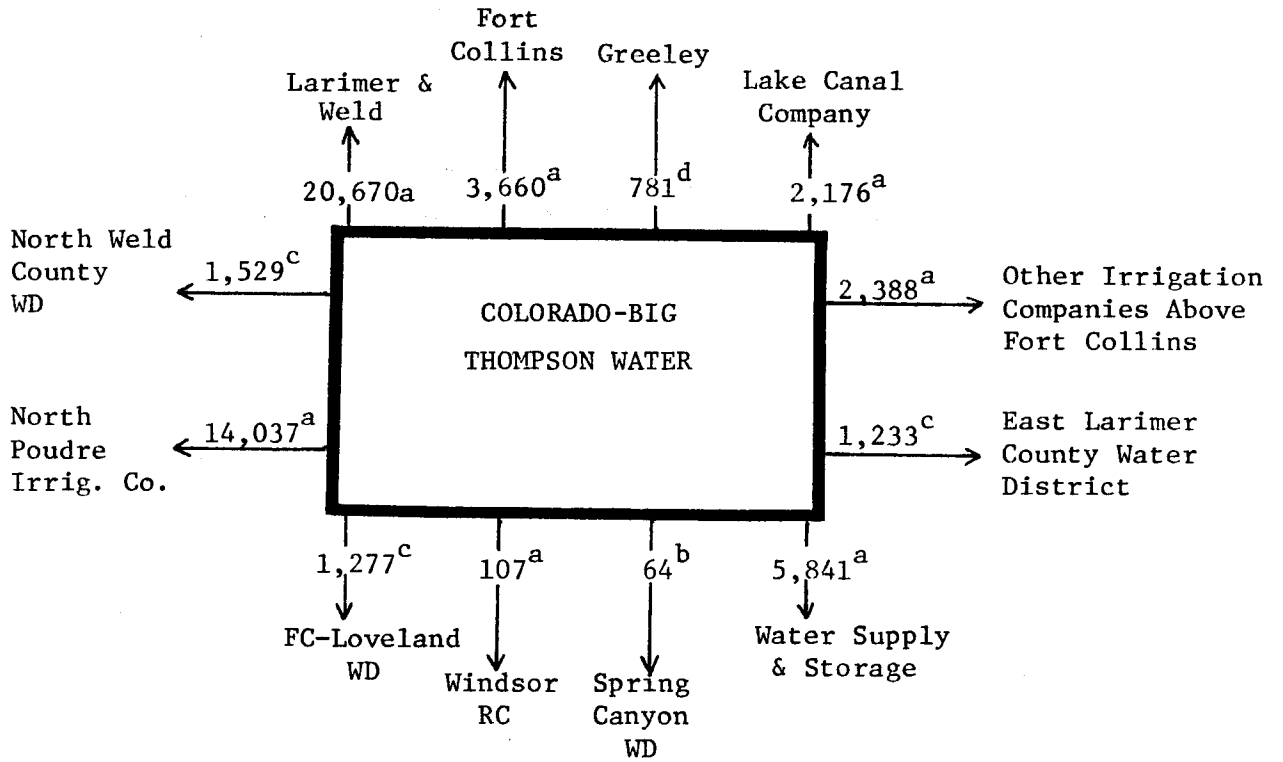

<sup>a</sup>See Table B-1

<sup>b</sup>Records Spring Canyon Water and Sanitation District

<sup>c</sup>Dannels (1980)

<sup>d</sup>Mass Balanced from City Records (Greeley, 1979)

A-8. Water Volumes Originated from Colorado-Big Thompson Water Project

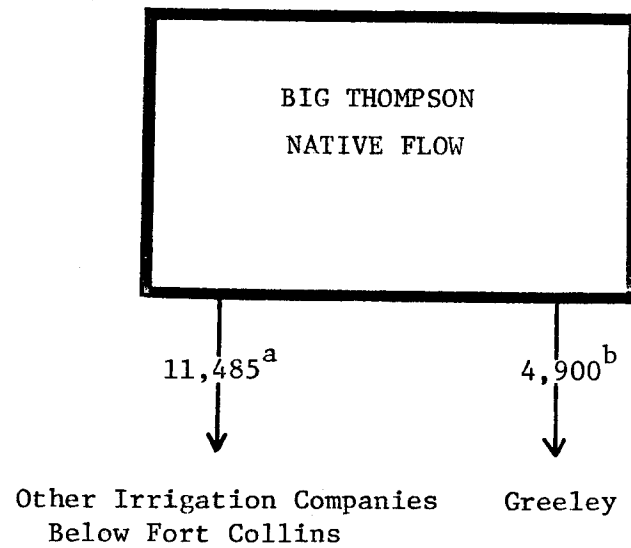

<sup>a</sup>Water Input to Louden Ditch, Boomerang Lateral, and Grapevine Ditch (Benson, 1980)

<sup>b</sup>Mass Balance from City Records (Greeley, 1980)

A-9. Water Volumes Originated from Big Thompson, Native Flow

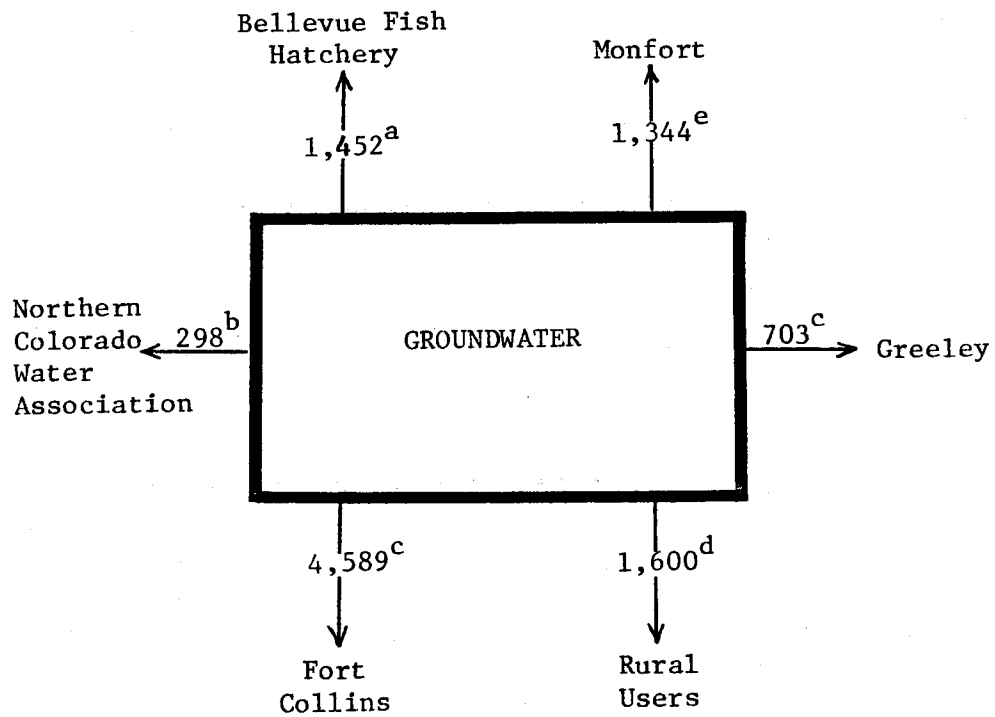

<sup>a</sup>Patterson (1977)

<sup>b</sup>Records of Northern Colorado Water Association

<sup>c</sup>Mass Balance

<sup>d</sup>Estimated by Author

<sup>e</sup>Merle Chapman (1980)

A-10. Water Volumes Originated from Groundwater



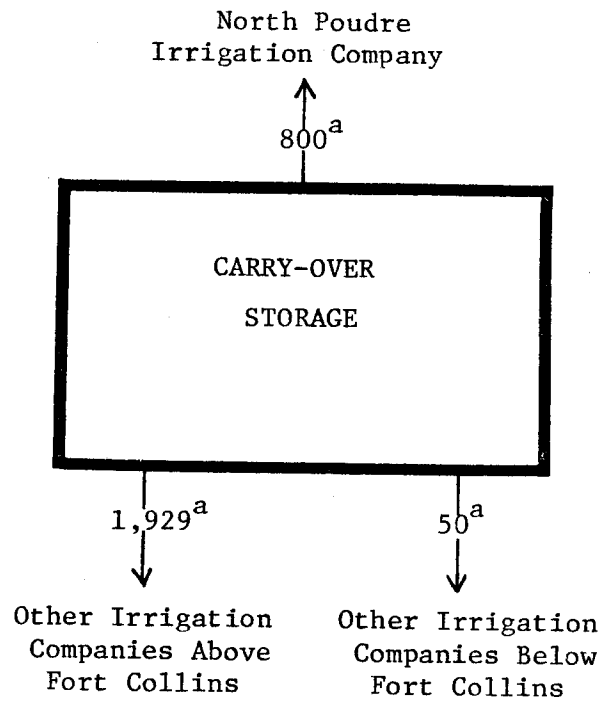

<sup>a</sup>See Table B-1

A-11. Water Volumes Originated from Carry-Over Storage

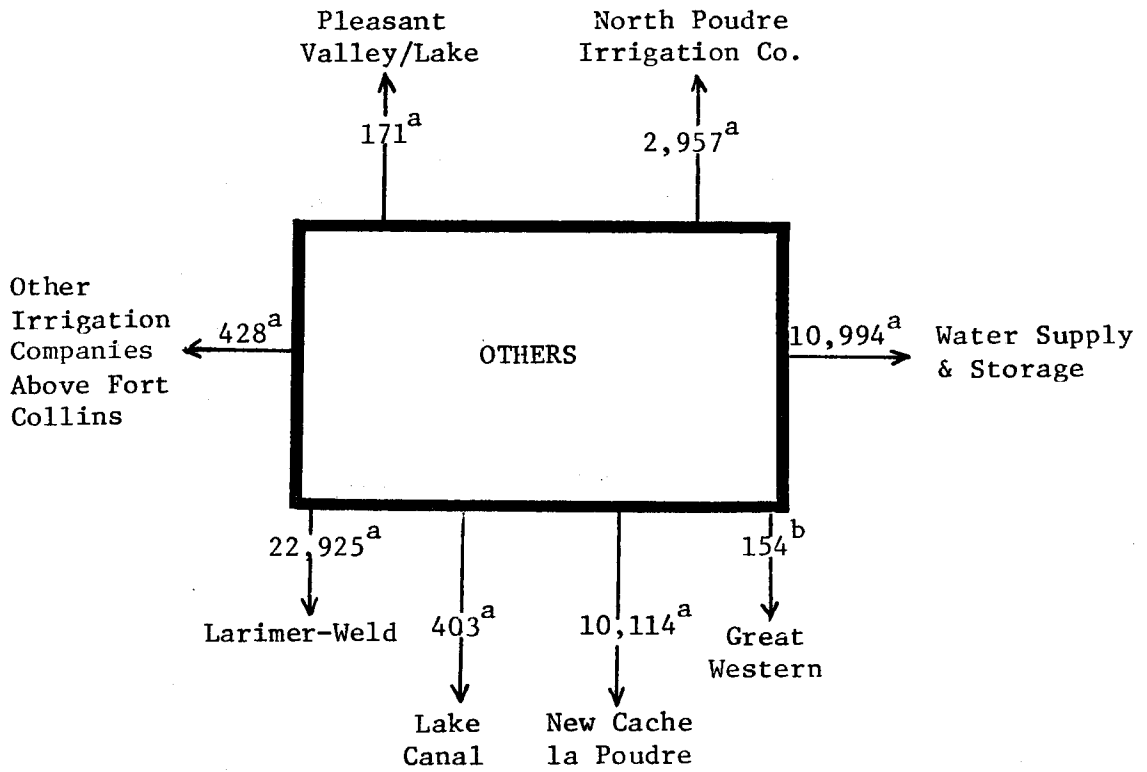

<sup>a</sup>Off-Stream Storage (Neutze, 1980)

<sup>b</sup>Beet Humidity (Brenton, 1980)

A-12. Water Volumes Originated from "Others"

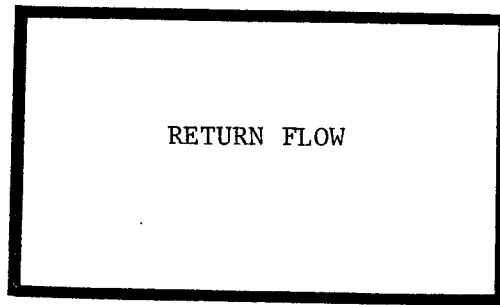

Documentation of Return Flow Data See  
Contributing and Receiving Components

A-13. Water Balance of Return Flow

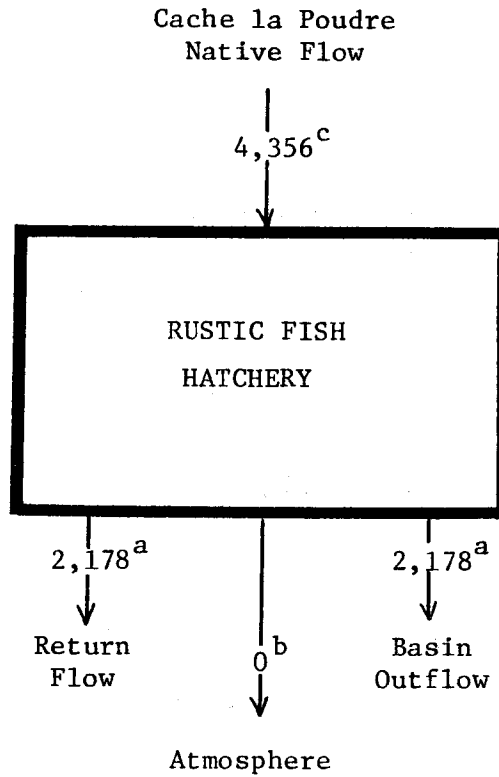

<sup>a</sup>It is assumed that 50 percent of the total input are picked up as "return flow" further downstream and 50 percent leave the basin.

<sup>b</sup>Neglectable

<sup>c</sup>Patterson (1977)

A-14. Water Balance of Rustic Fish Hatchery

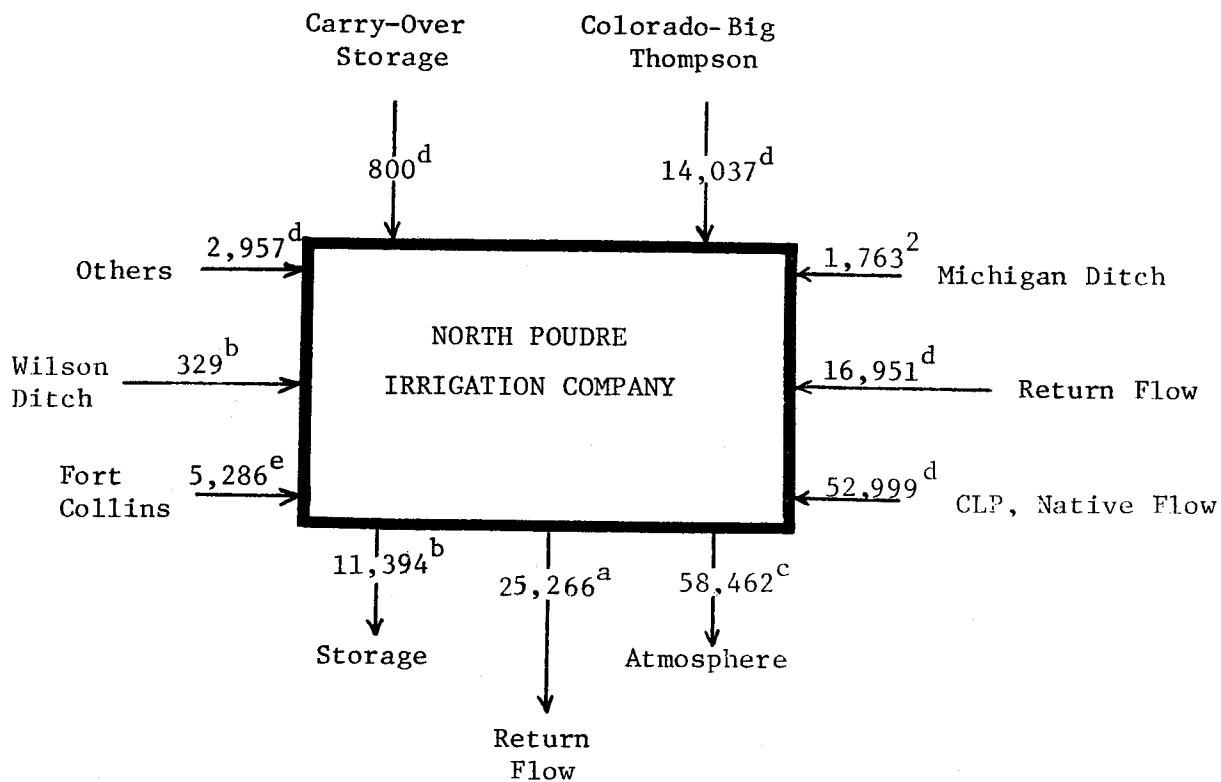

<sup>a</sup>Sixty-seven percent Consumptive Loss Assumed

<sup>b</sup>Neutze (1980)

<sup>c</sup>Mass Balanced

<sup>d</sup>See Table B-1

<sup>e</sup>Treatment Plant Effluent (Fort Collins, 1979)

A-15. Water Balance of North Poudre Irrigation Company

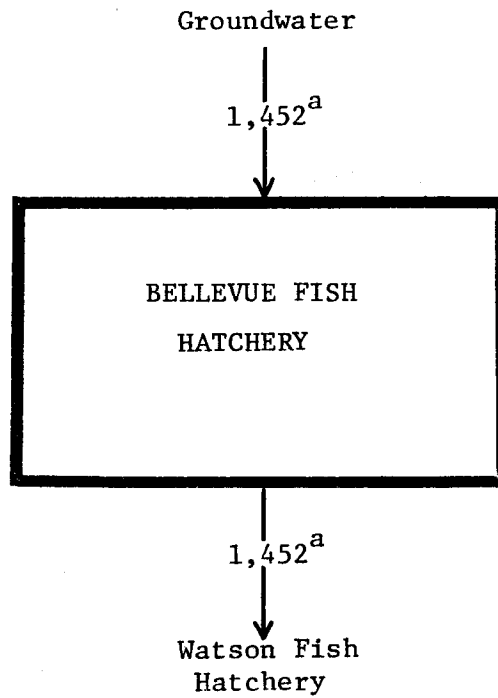

<sup>a</sup>Patterson (1977)

A-16. Water Balance of Bellevue Fish Hatchery

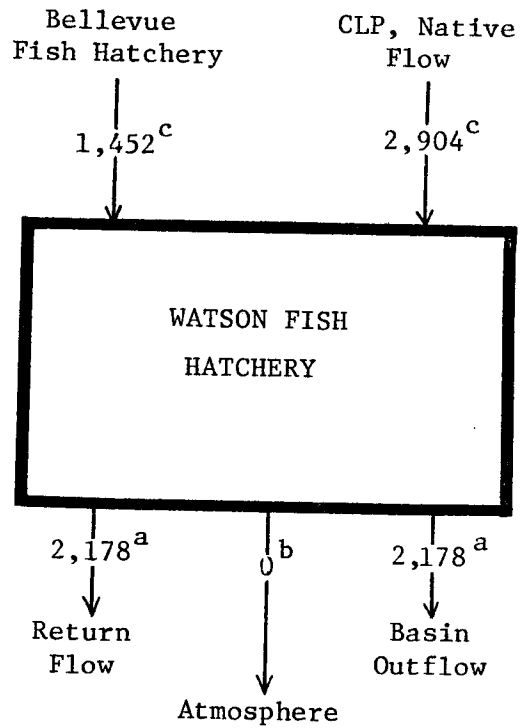

<sup>a</sup> It is assumed that 50 percent of the total input are picked up as "return flow" further downstream and 50 percent leave the basin.

<sup>b</sup> Neglectable

<sup>c</sup> Patterson (1977)

A-17. Water Balance of Watson Fish Hatchery

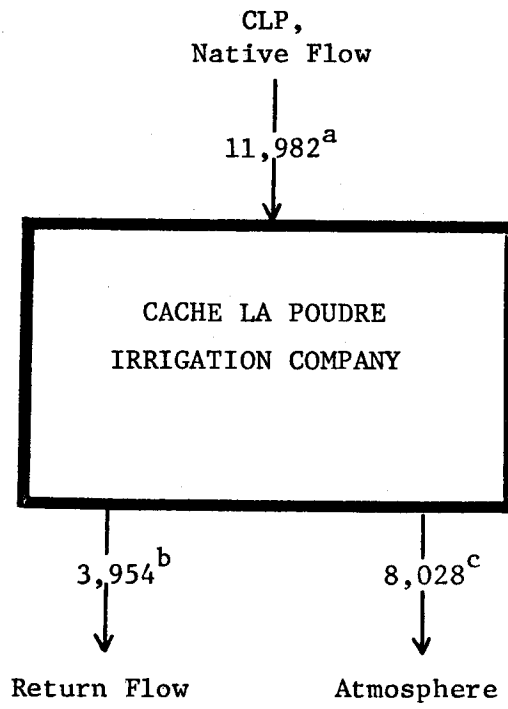

<sup>a</sup>See Table B-1

<sup>b</sup>Sixty-seven percent Consumptive Loss Assumed

<sup>c</sup>Mass Balanced

A-18. Water Balance of Cache la Poudre Irrigation Company



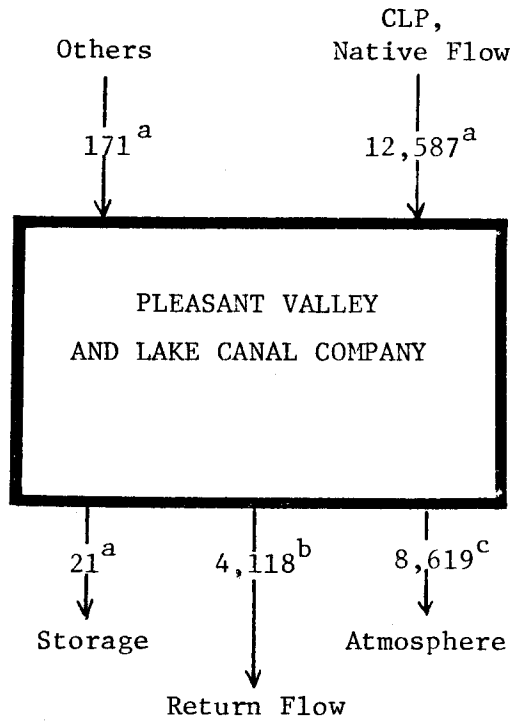

<sup>a</sup> See Table B-1

<sup>b</sup> Sixty-seven Percent Consumptive Loss Assumed

<sup>c</sup> Mass Balanced

A-19. Water Balance of Pleasant Valley and Lake Canal Company

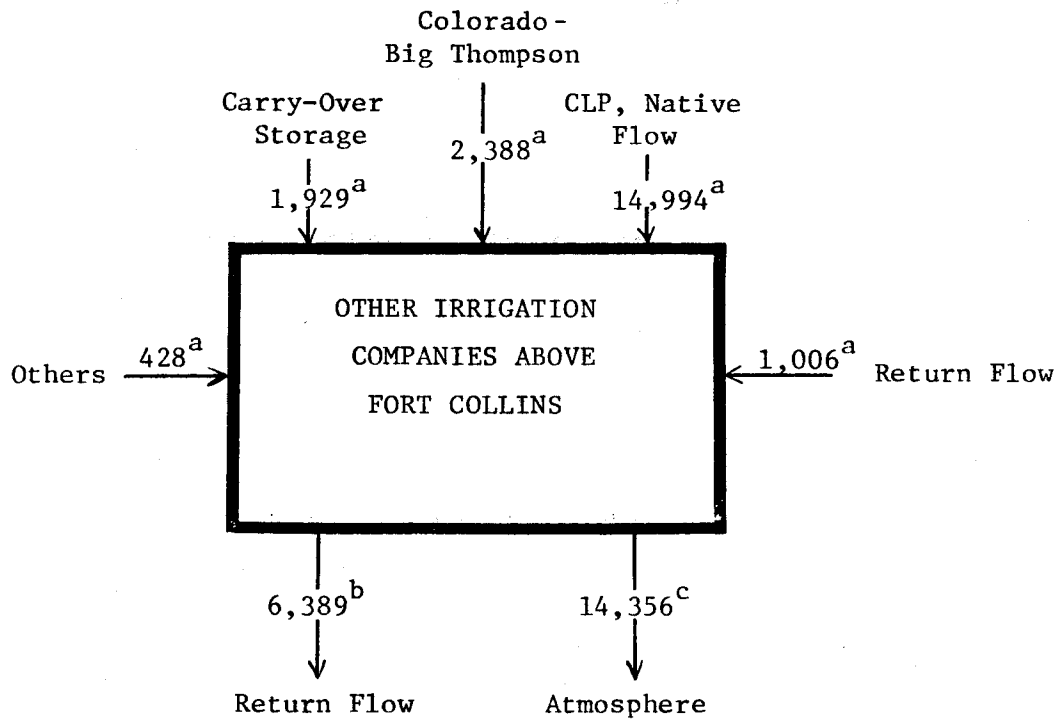

<sup>a</sup> See Table B-1

<sup>b</sup> Sixty-seven Percent Consumptive Loss Assumed

<sup>c</sup> Mass Balanced

A-20. Water Balance of Other Irrigation Companies Above Fort Collins

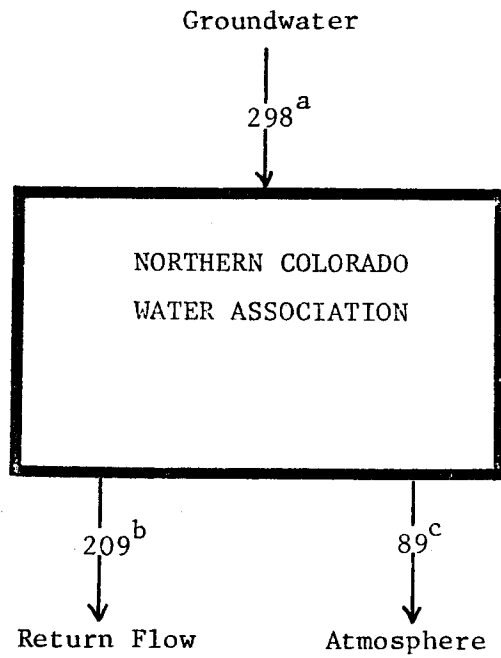

<sup>a</sup> Records of Northern Colorado Water Association

<sup>b</sup> Thirty Percent Consumptive Loss Assumed

<sup>c</sup> Mass Balanced

A-21. Water Balance of Northern Colorado Water Association

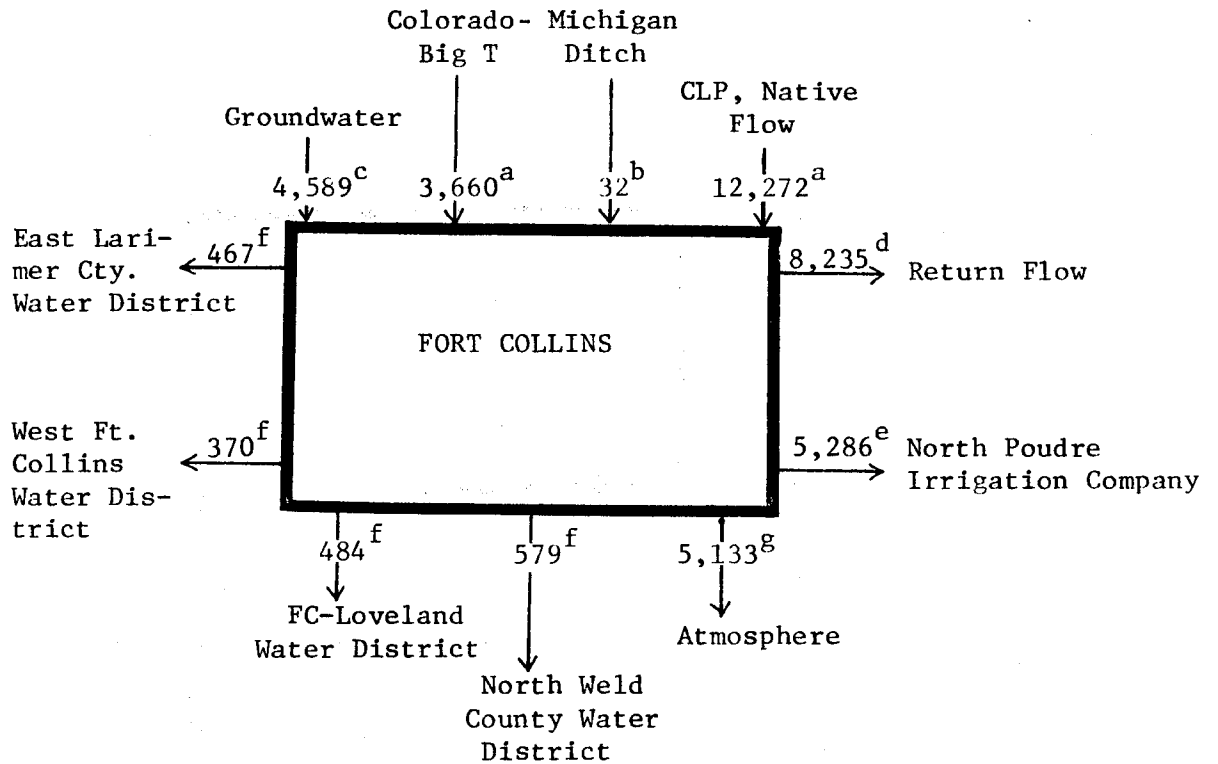

<sup>a</sup>See Table B-1

<sup>b</sup>Neutze (1980)

<sup>c</sup>Mass Balanced from City Records

<sup>d</sup>36.5 Percent Consumptive Loss Assumed

<sup>e</sup>Treatment Plant Effluent

<sup>f</sup>Water Transfer

<sup>g</sup>Mass Balanced

A-22. Water Balance of Fort Collins

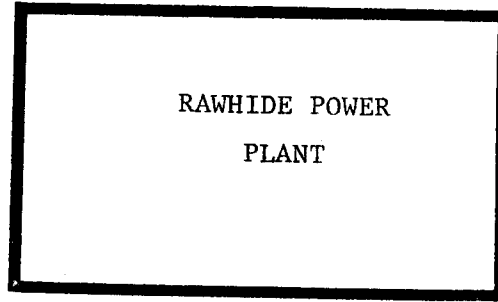

No Water Use in 1979

A-23. Water Balance of Rawhide Power Plant

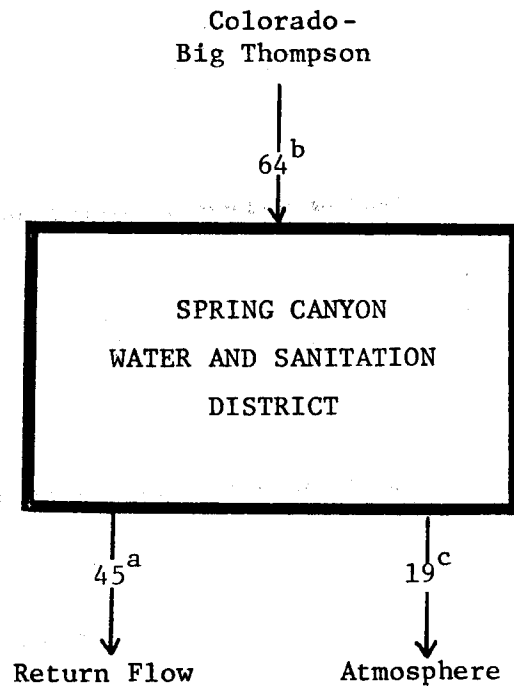

<sup>a</sup>Thirty Percent Consumptive Loss Assumed

<sup>b</sup>Records Spring Canyon Water and Sanitation District

<sup>c</sup>Mass Balanced

A-24. Water Balance of Spring Canyon Water and Sanitation District

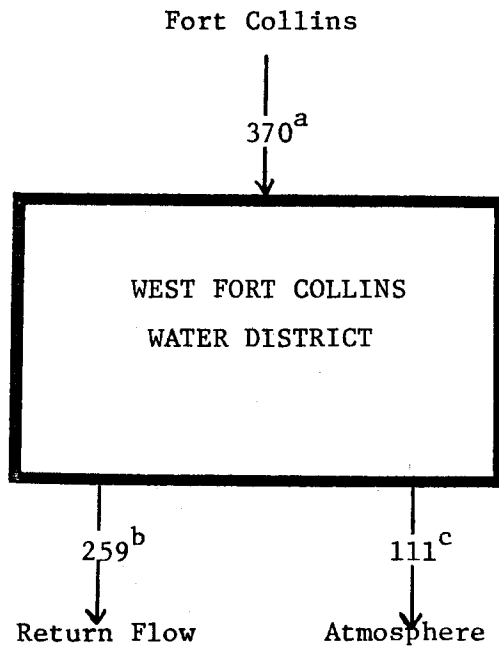

<sup>a</sup>Fort Collins (1979)

<sup>b</sup>Thirty Percent Consumptive Loss Assumed

<sup>c</sup>Mass Balanced

A-25. Water Balance of West Fort Collins Water District

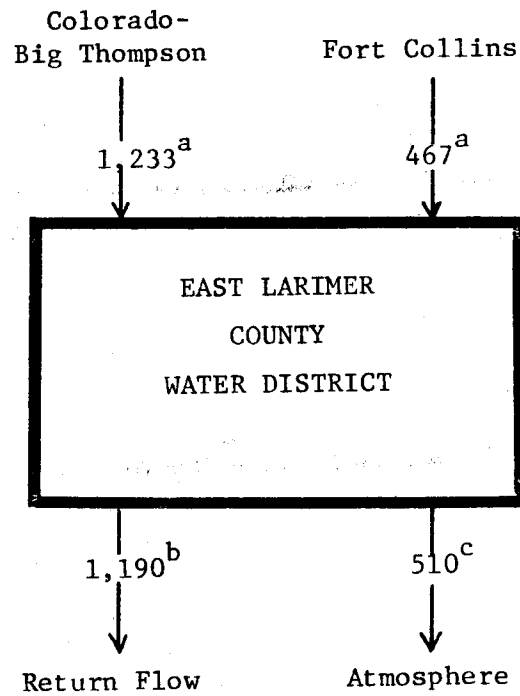

<sup>a</sup>Dannels (1980)

<sup>b</sup>Thirty Percent Consumptive Loss Assumed

<sup>c</sup>Mass Balanced

A-26. Water Balance of East Larimer County Water District



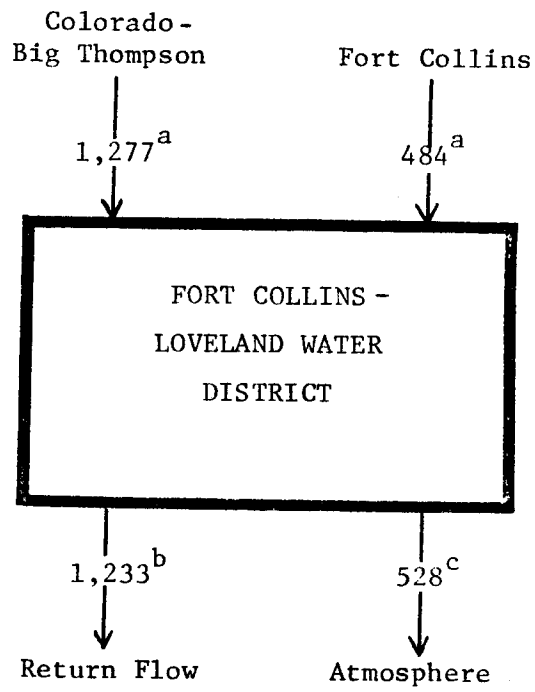

<sup>a</sup>Dannels (1980)

<sup>b</sup>Thirty Percent Consumptive Loss Assumed

<sup>c</sup>Mass Balanced

A-27. Water Balance of Fort Collins-Loveland Water District

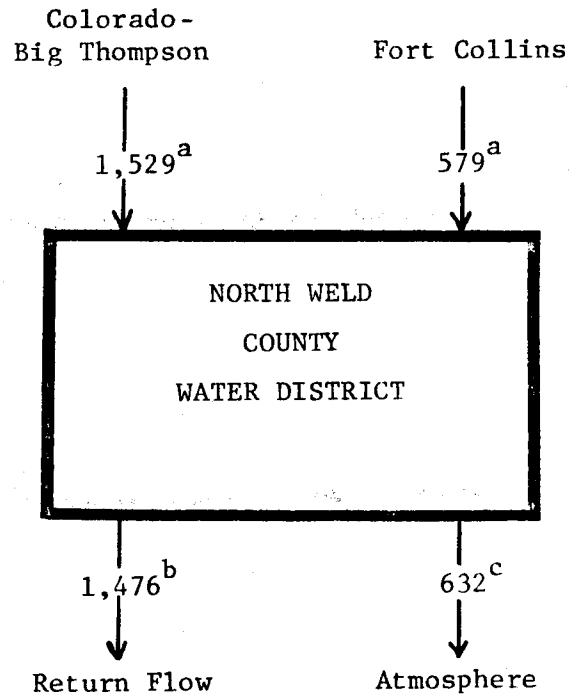

<sup>a</sup>Dannels (1980)

<sup>b</sup>Thirty Percent Consumptive Loss Assumed

<sup>c</sup>Mass Balanced

A-28. Water Balance of North Weld County Water District

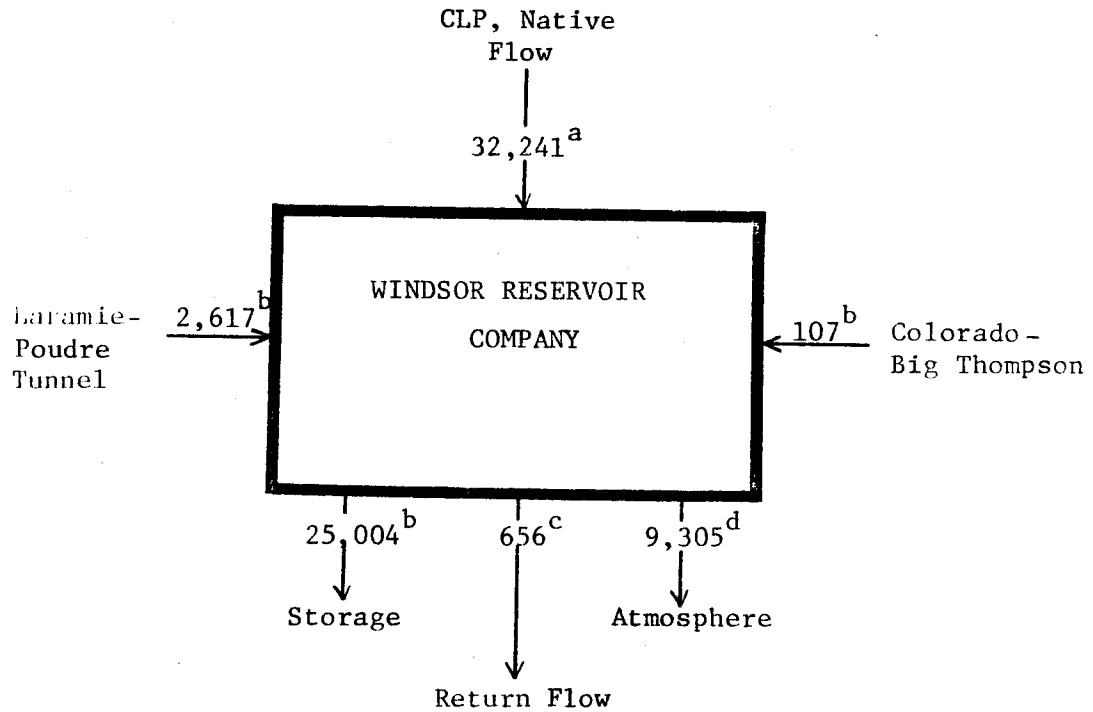

<sup>a</sup>See Table B-1

<sup>b</sup>Neutze (1980)

<sup>c</sup>Sixty-seven Percent Consumptive Loss Assumed

<sup>d</sup>Mass Balanced

A-29. Water Balance of Windsor Reservoir Company

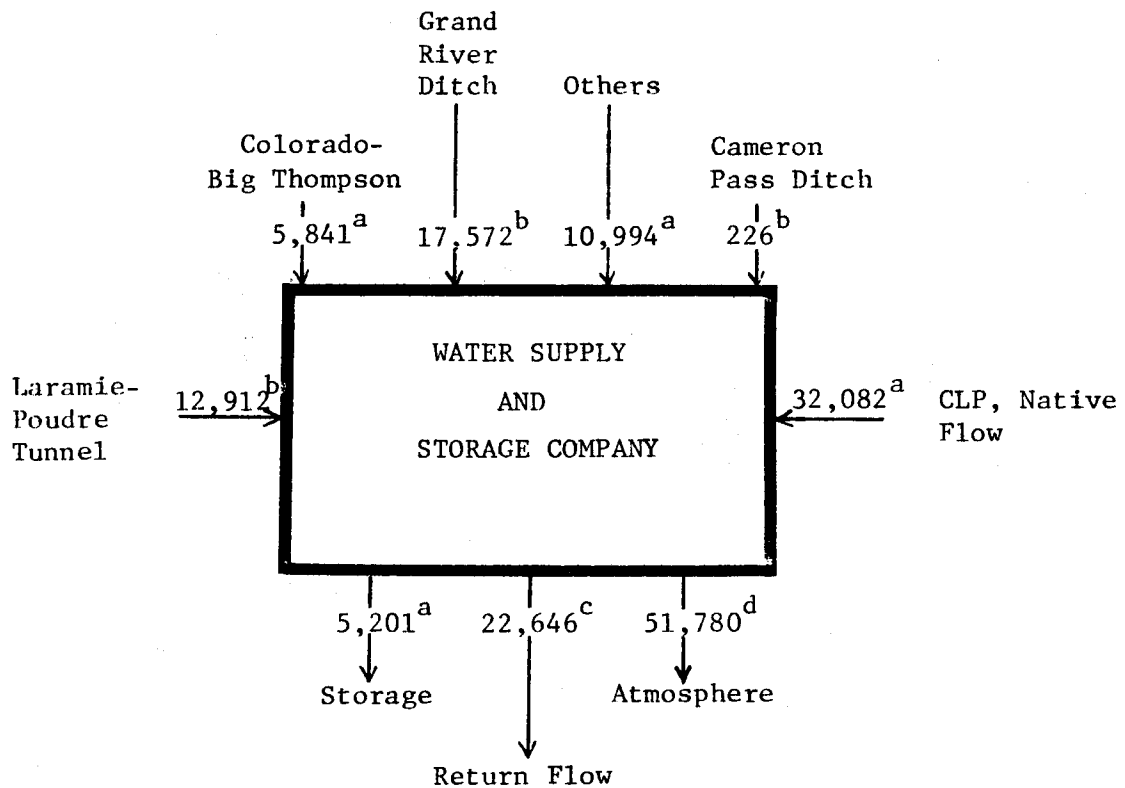

<sup>a</sup> See Table B-1

<sup>b</sup> Neutze (1980)

<sup>c</sup> Sixty-seven Percent Consumptive Loss Assumed

<sup>d</sup> Mass Balanced

A-30. Water Balance of Water Supply and Storage Company

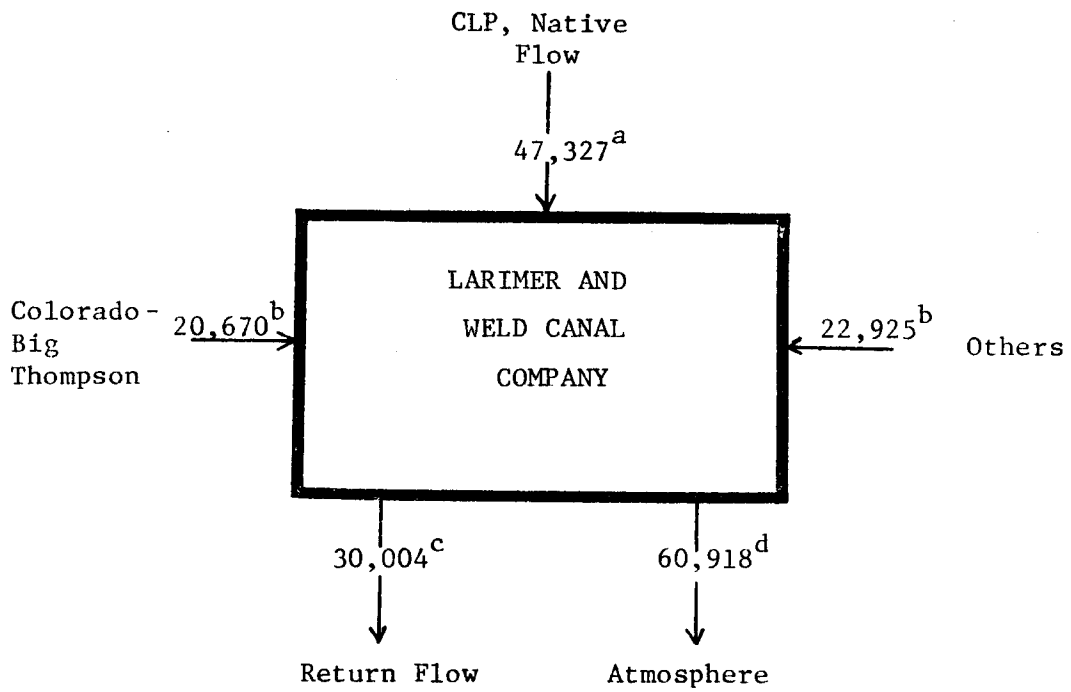

<sup>a</sup> See Table B-1

<sup>b</sup> Neutze (1980)

<sup>c</sup> Sixty-seven Percent Consumptive Loss Assumed

<sup>d</sup> Mass Balanced

A-31. Water Balance of Larimer and Weld Canal Company

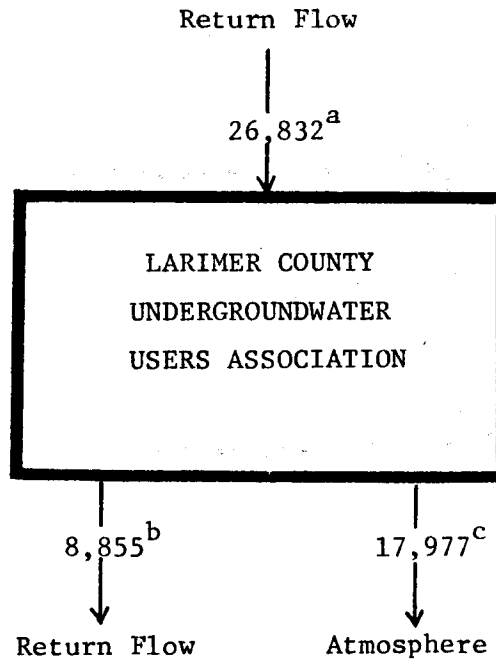

<sup>a</sup>It is assumed that all of the groundwater pumped originates from return flows (Neutze, 1980).

<sup>b</sup>Sixty-seven Percent Consumptive Loss Assumed

<sup>c</sup>Mass Balanced

A-32. Water Balance of Larimer County Undergruowater Users Association

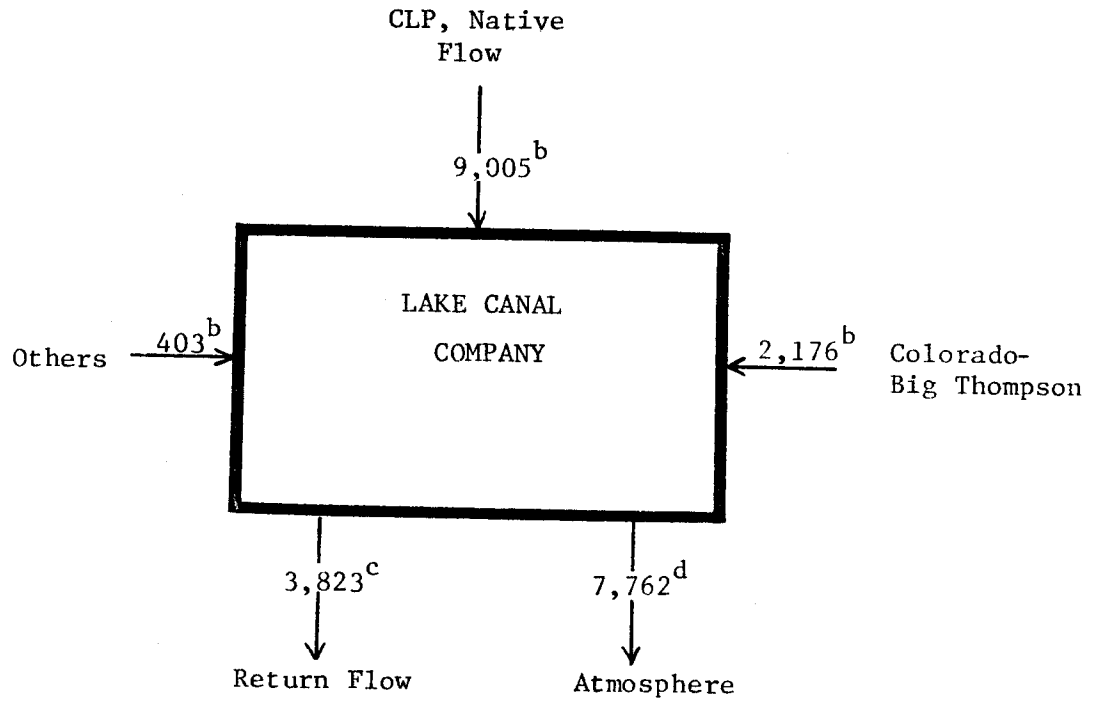

<sup>a</sup>See Table B-1

<sup>b</sup>Neutze (1980)

<sup>c</sup>Sixty-seven Percent Consumptive Loss Assumed

<sup>d</sup>Mass Balanced

A-33. Water Balance of Lake Canal Company

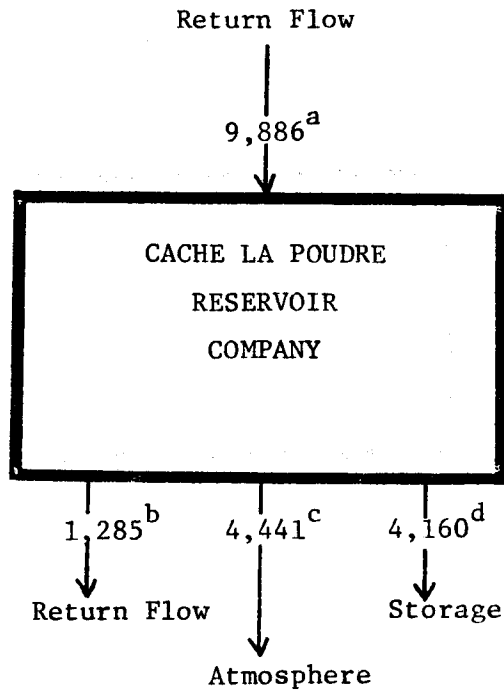

<sup>a</sup> See Table B-1

<sup>b</sup> Sixty-seven Percent Consumptive Loss Assumed

<sup>c</sup> Mass Balanced

<sup>d</sup> Neutze (1980)

A-34. Water Balance of Cache la Poudre Reservoir Company



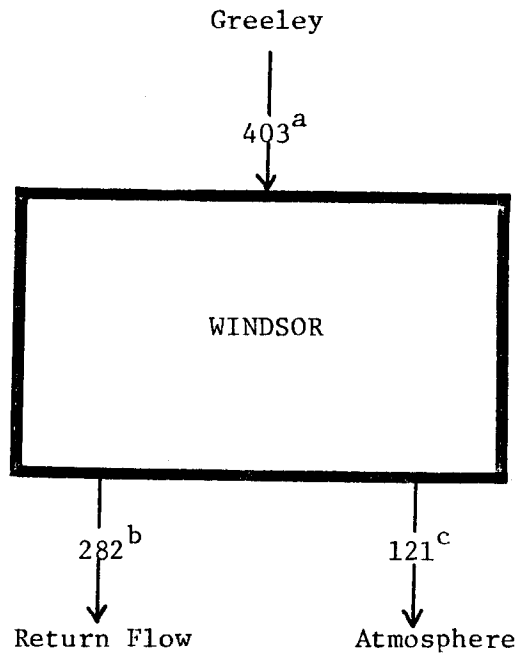

<sup>a</sup>Greeley (1979)

<sup>b</sup>Thirty Percent Consumptive Loss Assumed

<sup>c</sup>Mass Balanced

A-35. Water Balance of Windsor

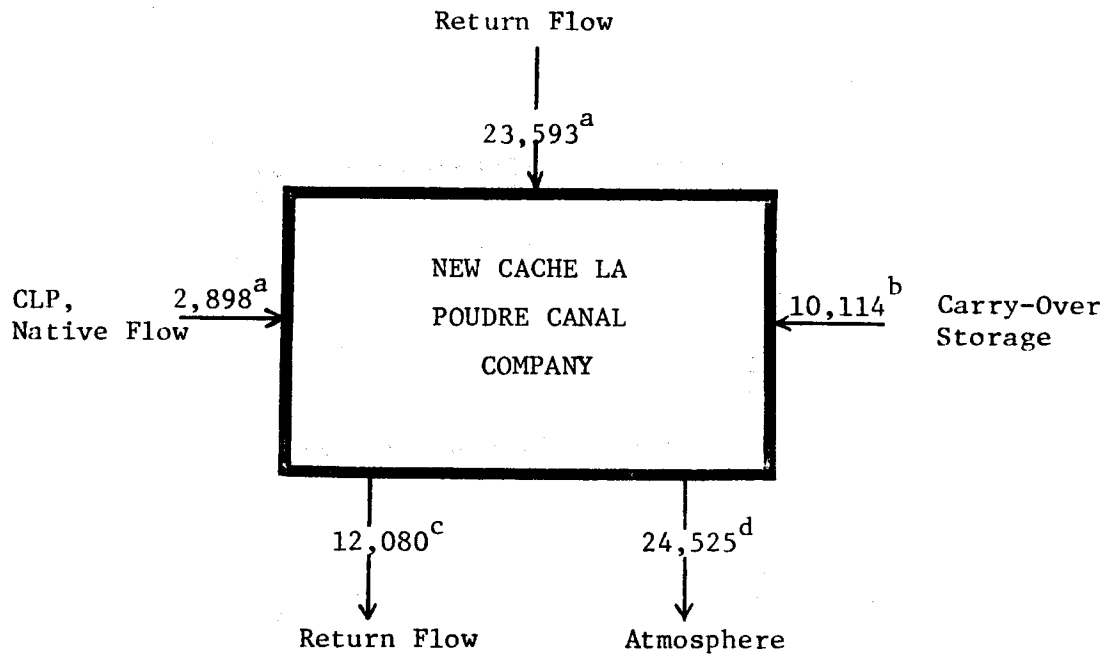

<sup>a</sup> See Table B-1

<sup>b</sup> Neutze (1980)

<sup>c</sup> Sixty-seven Percent Consumptive Loss Assumed

<sup>d</sup> Mass Balanced

A-36. Water Balance of New Cache la Poudre Canal Company

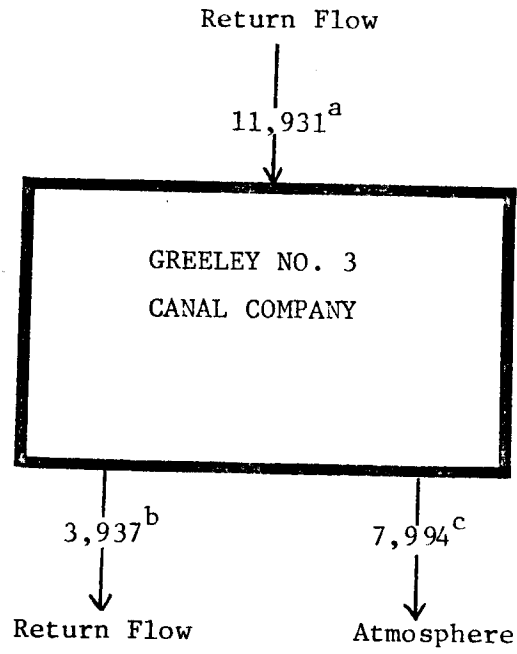

<sup>a</sup> See Table B-1

<sup>b</sup> Sixty-seven Percent Consumptive Loss Assumed

<sup>c</sup> Mass Balanced

A-37. Water Balance of Greeley No. 3 Canal Company

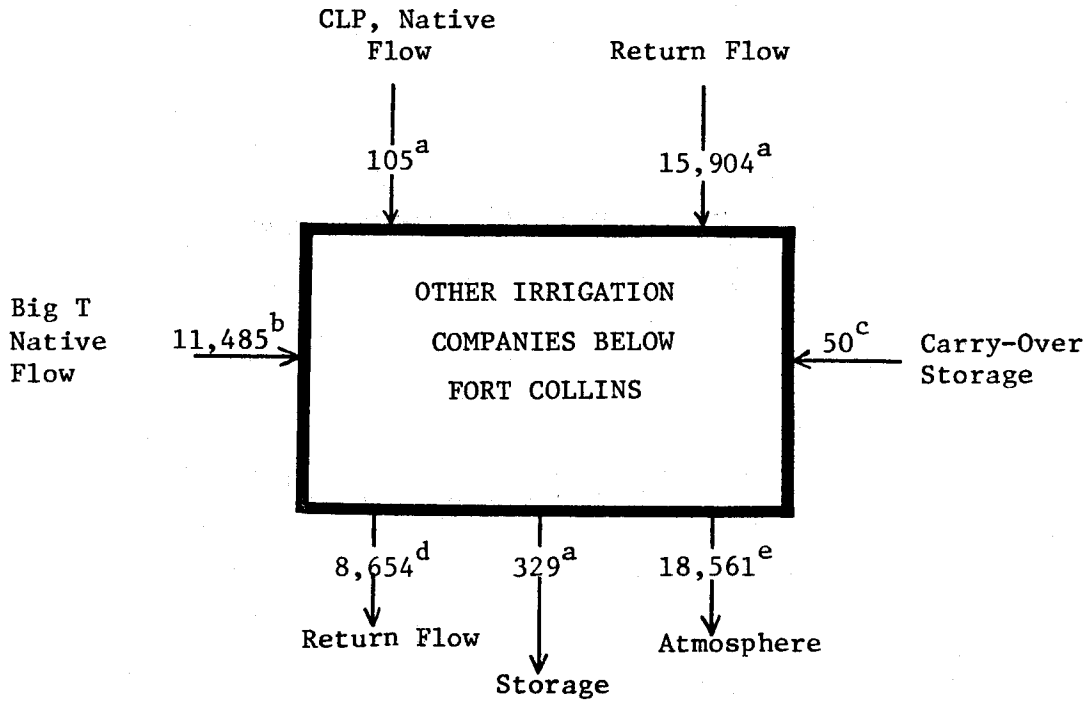

<sup>a</sup> See Table B-1

<sup>b</sup> Benson (1980)

<sup>c</sup> Neutze (1980)

<sup>d</sup> Sixty-seven Percent Consumptive Loss Assumed

<sup>e</sup> Mass Balanced

A-38. Water Balance of Other Irrigation Companies Below Fort Collins

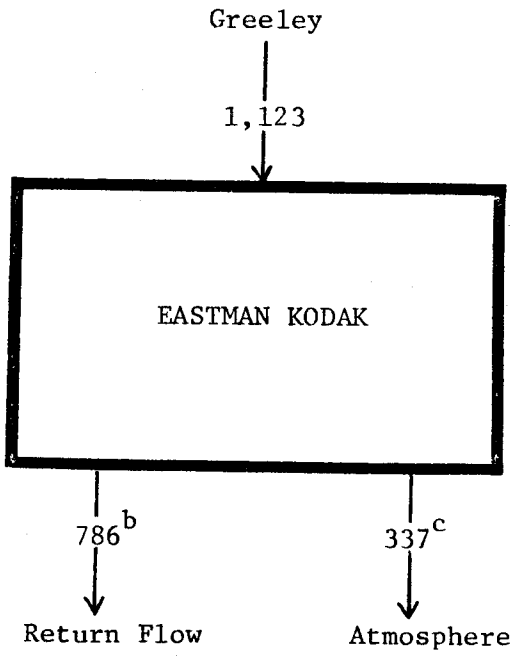

<sup>a</sup>Greeley (1979)

<sup>b</sup>Thirty Percent Consumptive Loss Assumed

<sup>c</sup>Mass Balanced

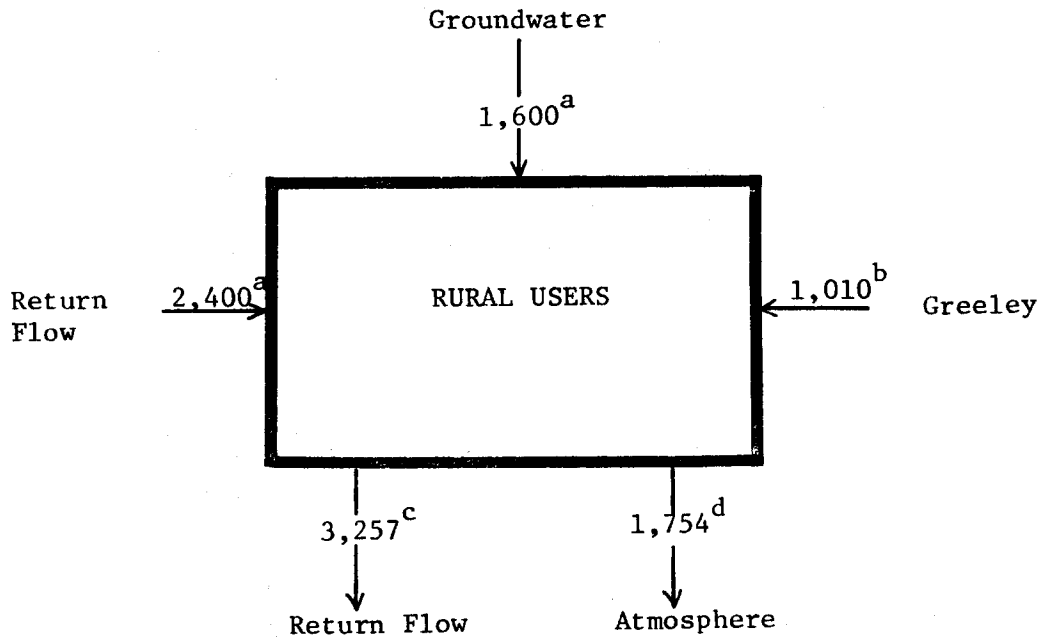

<sup>a</sup> Estimate, Based on Reitano (1979)

<sup>b</sup> Greeley (1980)

<sup>c</sup> Thirty Percent Consumptive Loss Assumed

<sup>d</sup> Mass Balanced

A-40. Water Balance of Rural Users

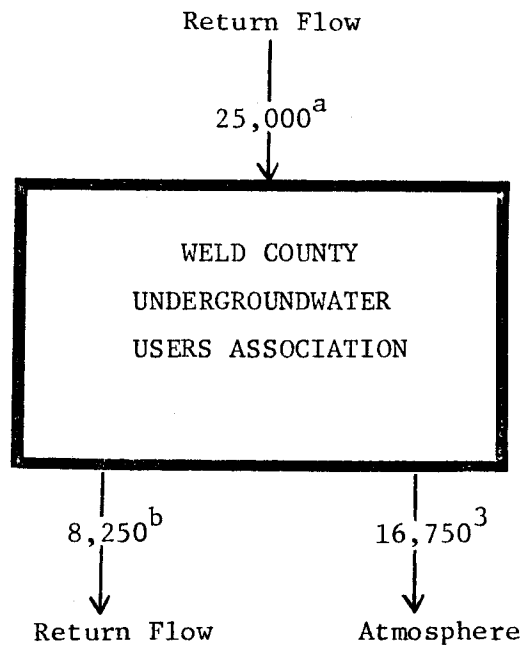

<sup>a</sup>It is assumed that all of the groundwater pumped originates from return flows (Neutze, 1980).

<sup>b</sup>Sixty-seven Percent Consumptive Loss Assumed

<sup>c</sup>Mass Balanced

A-41. Water Balance of Weld County Undergroundwater Users Association

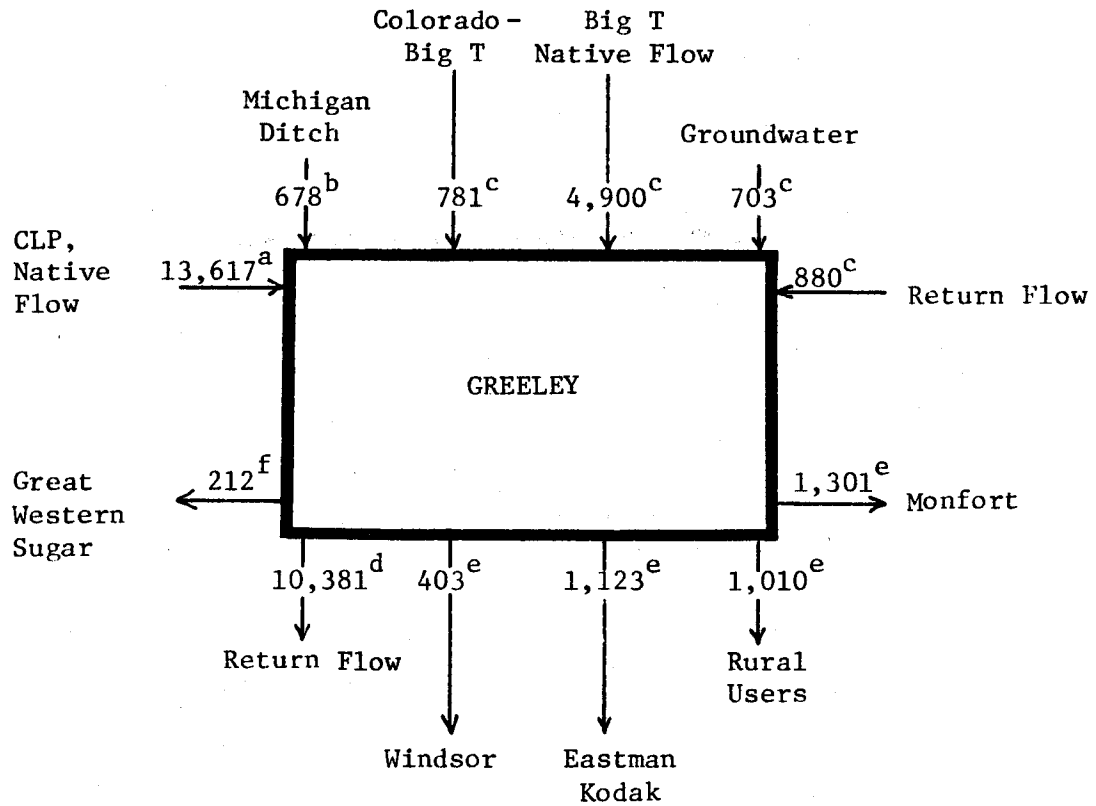

<sup>a</sup> See Table B-1

<sup>b</sup> Neutze (1980)

<sup>c</sup> Greeley (1979)

<sup>d</sup> 36.5 Percent Consumptive Loss Assumed

<sup>e</sup> Water Transfer (Greeley, 1979)

<sup>f</sup> Brenton (1980)

A-42. Water Balance of Greeley



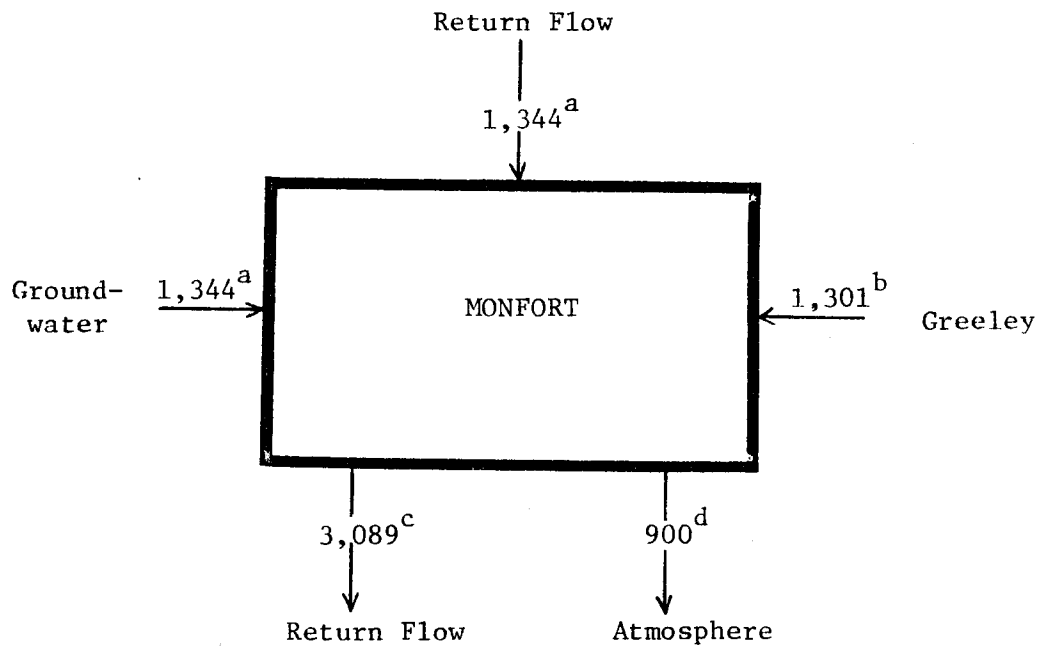

<sup>a</sup>Chapman (1980); Fifty Percent of Groundwater Pumpage is Believed to be Return Flow

<sup>b</sup>Greeley (1979)

<sup>c</sup>Thirty Percent Consumptive Loss Assumed

<sup>d</sup>Mass Balanced

A-43. Water Balance of Monfort Meatpacking Plant

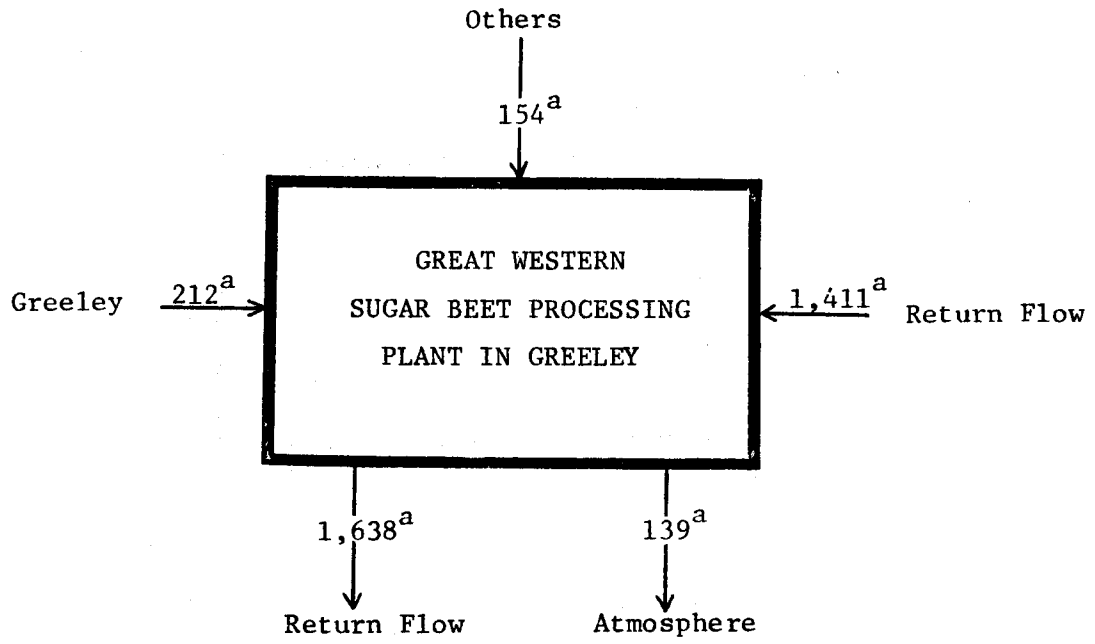

<sup>a</sup>Brenton (1980)

A-44. Water Balance of Great Western Sugar Beet Processing Plant in Greeley

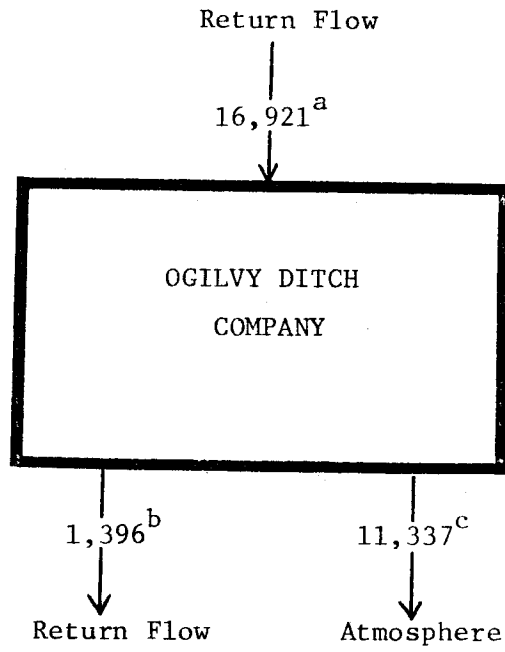

<sup>a</sup> See Table B-1

<sup>b</sup> Sixty-seven Percent Consumptive Loss Assumed

<sup>c</sup> Mass Balanced

A-45. Water Balance of Ogilvy Ditch Company

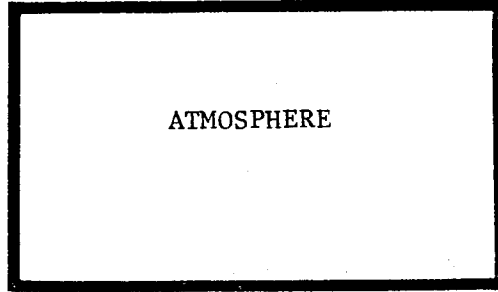

Documentation of Atmosphere Data  
See Contributing Components

A-46. Documentation of Data for Atmosphere

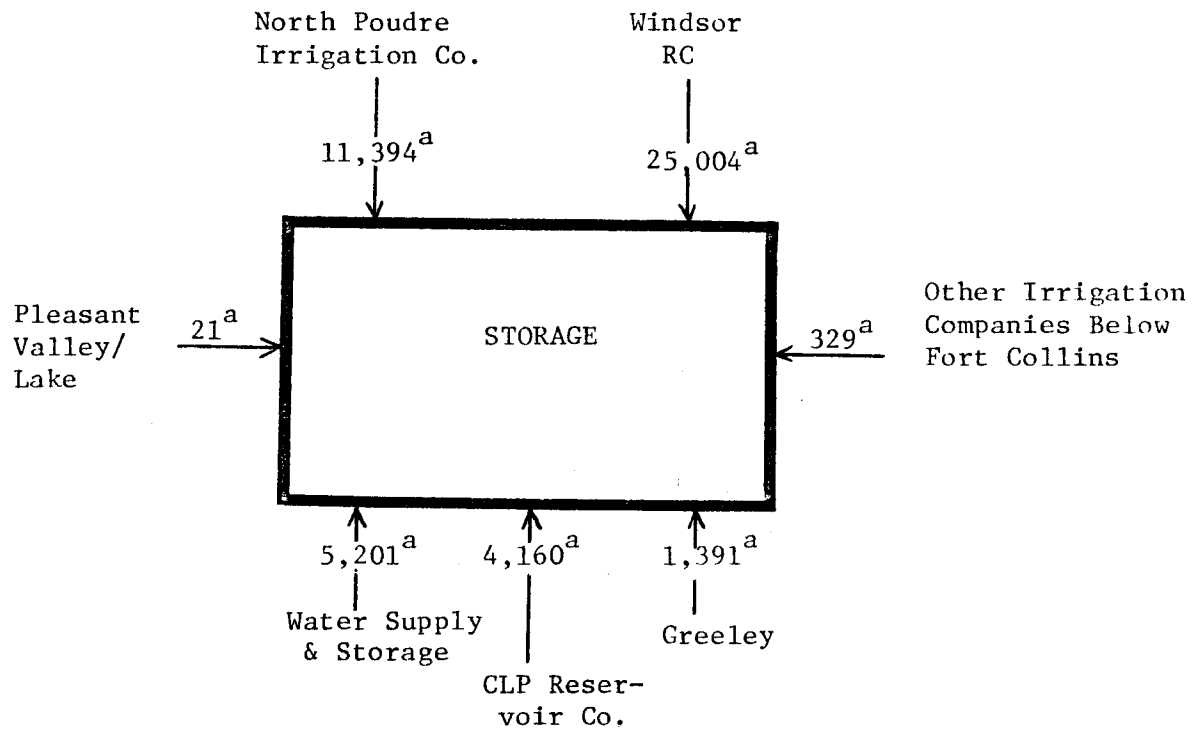

<sup>a</sup>See Table B-1

A-47. Water Volumes Put to Storage

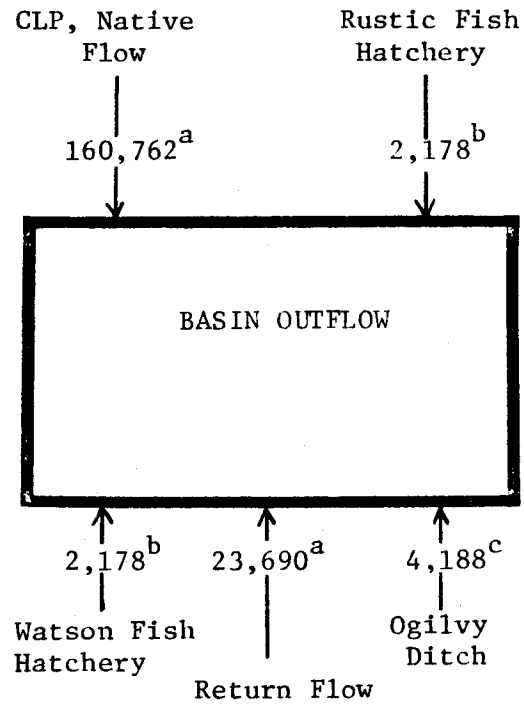

<sup>a</sup> Mass Balanced

<sup>b</sup> It is assumed that 50 Percent of the output of Rustic Fish Hatchery leaves the basin.

<sup>c</sup> Return Flows Occurring Outside of the Basin

A-48. Water Volumes Leaving the Basin

APPENDIX B

DOCUMENTATION OF DATA

TABLE B-1. WATER DIVERSIONS OF IRRIGATION COMPANIES IN THE WATER YEAR 1979

Use System	From CLP <sup>a</sup> Native Flow <sup>a</sup>	From Colorado Big Thompson	From Others <sup>b</sup>	From Return Flow <sup>d</sup>	To Storage	Storage Evaporation <sup>c</sup>	To Return Flow	Consumptive Use
North Poudre Irrigation Company	52,999	14,037	5,849	22,237	11,394	7,163	25,266	51,299
Windsor Reservoir Co.	32,241	107	2,617	--	25,004	7,974	656	1,331
Other Irrigation Com- panies Above Ft. Collins	11,644	2,388	2,357	1,006	0	1,383	6,389	12,973
Pleasant Valley and Lake Canal	12,587	--	171	--	21	259	4,118	8,360
Water Supply and Storage Company	32,082	5,841	41,704	--	5,201	5,802	22,646	45,978
Cache la Poudre Irri- gation Company	11,982	--	--	--	--	--	3,954	8,028
Larimer and Weld Irrigation Company	47,327	20,670	22,925	--	--	--	30,004	60,918
New Cache la Poudre Ditch Company	2,898	--	10,114	23,593	--	--	12,080	24,525
Other Irrigation Com- panies Below Ft. Collins	105	11,485	50	15,904	329	991	8,654	17,570
Lake Canal Company	9,005	2,176	403	--	--	--	3,823	7,762
CLP Reservoir Company	--	--	--	9,886	4,160	1,831	1,285	2,610
Greeley No. 3	--	--	--	11,931	--	--	3,937	7,994
Ogilvy Ditch	--	--	--	16,921	--	--	5,584	11,337

All Values in Acre-Feet

<sup>a</sup> Equals sum of diversions based on direct flow rights and reservoir leases. For diversions from the Cache la Poudre River, downstream of the Lake Canal diversion, only water diverted to fill the reservoir in spring and reservoir releases are considered.

<sup>b</sup> Off-stream reservoir releases (including carry-over storage) and foreign waters.

<sup>c</sup> Based on an estimated average reservoir surface area in 1979. See Table B-2.

<sup>d</sup> Equals sum of diversions based on direct flow rights minus diversions to fill reservoirs in spring for points of diversion downstream of the Lake Canal diversion.

Source: Neutze (1980)



TABLE B-2. RESERVOIR CHARACTERISTICS 1979

Reservoir/Lake	Owner	Surface (acres)	Evaporation (feet)	Evaporation (acre-feet)	Safe Capacity (acre-feet)	Initial Storage (acre-feet)	Final Storage (acre-feet)	Volume To Storage (acre-feet)	Volume From Storage (acre-feet)
Chambers Lake	WSSC	227	2.6	590	8,824	4,579	5,351	772	--
Comanche Reservoir	Greeley	41	2.6	107	2,256	0	0	--	--
Long Draw Reservoir	WSSC	332	2.6	863	10,519	7,224	7,923	699	--
Barnes Meadow	Greeley	81	2.6	211	2,349	2,084	2,469	385	--
Joe Wright	Fort Collins	0	2.6	0	7,161	0	0	--	--
Black Hollow	WSSC	377	3.5	1,320	7,486	3,409	4,459	1,050	--
Terry Lake	Larimer & Weld Reservoir Co.	395	3.5	1,383	8,028	4,639	2,710	--	1,929
Horsetooth	USBR	1,389	3.5	4,862	151,752	22,250	103,084	80,834	--
Halligan	North Poudre	135	2.6	351	6,428	465	100	--	365
Claymore Lake	Pleasant Valley	74	3.5	259	978	529	550	21	--
Seaman Reservoir	Greeley	101	2.6	263	5,008	1,046	2,052	1,006	--
Cobb Lake	Windsor RC	568	3.5	1,988	22,300	3,535	19,950	16,415	--
North Poudre 5	North Poudre	305	3.5	1,068	7,217	2,828	2,828	--	--
North Poudre 6	North Poudre	107	3.5	375	4,500	0	2,580	2,580	--
Long Pond	WSSC	219	3.5	767	4,766	3,014	3,408	394	--
Fossil Creek	North Poudre	475	3.5	1,663	11,100	1,322	2,165	843	--
Tinnath Reservoir	Cache la Poudre Reservoir Co.	523	3.5	1,831	10,070	4,482	8,642	4,160	--
No. 8	Windsor RC	501	3.5	1,754	13,727	7,434	10,499	3,065	--
Douglas Reservoir	Windsor RC	457	3.5	1,600	8,834	5,337	6,300	963	--
Windsor Reservoir	Windsor RC	752	3.5	2,632	17,689	5,516	10,077	4,561	--
Curtis Lake	WSSC	110	3.5	385	1,259	629	874	245	--
North Poudre 2	North Poudre	208	3.5	728	3,714	1,898	1,483	--	415
North Poudre 3	North Poudre	41	3.5	144	2,760	0	0	--	--
North Poudre 4	North Poudre	91	3.5	319	1,386	573	955	382	--
North Poudre 15	North Poudre	241	3.5	844	5,517	1,284	4,248	2,964	--
Clark's Lake	North Poudre	145	3.5	508	871	568	548	--	20
Indian Creek	North Poudre	143	3.5	501	1,906	1,399	1,906	507	--
Kluver Reservoir	WSSC	84	3.5	294	1,231	751	802	51	--
Rocky Ridge	WSSC	196	3.5	686	4,493	2,973	3,283	310	--
WSSC 3	WSSC	181	3.5	634	4,888	2,256	3,840	1,584	--
WSSC 4	WSSC	75	3.5	263	1,371	739	835	96	--
Wood	(Others Below)	160	3.5	560	2,608	1,474	1,724	--	50
Park Creek	North Poudre	189	3.5	662	7,320	2,051	6,169	4,118	--
Warren Lake	Warren Lake Res.	123	3.5	431	2,089	277	606	329	--

Source: Neutze (1980)

Table B-3. Maximal Tolerable Salinity Levels for Beneficial Uses in mg/l TDS

Beneficial Use	TDS Level (mg/l)	Reference
Domestic Raw Water Supply	300	a
Groundwater Recharge (injection)	600	a
Groundwater Recharge (land spreading)	600-800	b
Agricultural Irrigation	700-2100	b
Landscape Irrigation	1200	b
Livestock and Wildlife Watering	3000	b
Power Plant and Industrial Cooling (once-through basis)	1000	b
Recirculation Cooling	500-800	b
Boiler Feed Water	200-700	b
Food and Kindred Products Industry	500	b
Paper and Allied Products Industry	250	b
Chemical and Allied Products Industry	2500	b
Petroleum and Allied Products Industry	1000	b
Primary Metals Industry	accepted as received (1500)	c
Primary Contact Recreation	2000	a
Secondary Contact Recreation	2000	a
Cold Water Fishery	2000	a
Warm Water Fishery	2000	a

<sup>a</sup> Estimated by the author.

<sup>b</sup> Culp, Wesner, Culp, Water Reuse and Recycling, Volume II, Evaluation of Treatment Technology, US Department of the Interior, OWRT/RU-7912, April, 1979.

<sup>c</sup> United States Environmental Protection Agency, Quality Criteria for Water, US Govt. Prntg. Office, Washington, D.C., July, 1976.