



Erosion Control and Stormwater Quality Field Guide



2011

Perimeter
Control

Exposed Areas

Slopes

Ditches

Inlet/Outlet
Protection

Sediment
Traps/Basins

Pollution
Prevention

Special
Conditions

Important
Numbers

Colorado Department of
Transportation

Erosion Control and Stormwater Quality Field Guide

This Guide is designed to provide guidance for engineers, planners, landscape architects, and maintenance personnel in designing, installing, and maintaining best management practices (BMPs) to minimize water quality and quantity impacts from stormwater runoff.

The material in this Guide may have been updated after the printing. It is the responsibility of the user to verify that the project specifications and standard details are current.

*Cover Photo: US 50 in CDOT Region 2, along the
Arkansas River*

Clean Runoff Starts with You

This field guide is a reference for installers, Erosion Control Supervisors (ECS), and inspectors of erosion and sediment control and pollution prevention best management practices (BMPs) on construction sites. The guide contains information on common BMPs and is divided into several chapters—Perimeter Controls, Exposed Areas, Slopes, Ditches, Inlet and Outlet

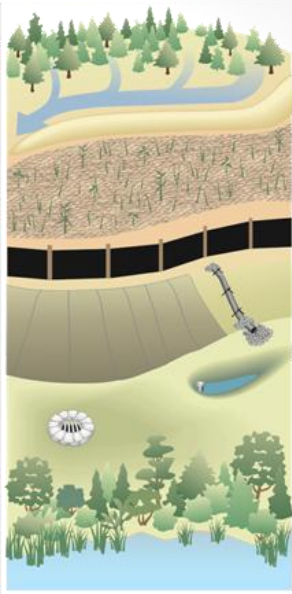

Protection, Sediment Traps and Basins, Pollution Prevention, and Special Conditions. For quick reference, “thumbs up” and “thumbs down” icons have been added to pictures to indicate if the BMP shown is a good or bad example of proper installation and maintenance.

Environmental Permits

All construction sites require stormwater BMPs. Construction sites that disturb 1 or more acres, with limited exceptions, require permit coverage under the Colorado Discharge Permit System/Stormwater Construction Permit (SCP). Construction sites that include dewatering require a Dewatering Permit.

These permits are administered by Colorado Department of Public Health and the Environment.

To download CDOT's forms to obtain coverage under these permits visit:

<http://www.dot.state.co.us/environmental/envWaterQuality/wqforms.asp>

A stormwater management plan (SWMP) is a requirement for all CDOT construction sites. The SWMP includes BMPs to prevent pollution that results from construction and from activities, such as vehicle maintenance, hazardous waste storage, sanitary waste facilities, and fueling operations.

Why Do We Need to Control Erosion and Sediment Losses from Construction Activities?

Erosion control is desirable not only for environmental reasons but also for highway safety purposes. Uncontrolled erosion during highway construction, and subsequent sedimentation, could potentially cause adverse impacts on streams, damage to drainage structures and public or private lands, and cause public criticism. When installed correctly, BMPs minimize soil erosion which prevents sedimentation into nearby state waters. Remember that stormwater is not treated before being discharged into state waters. State waters are defined to be any and all surface and subsurface waters which are contained in or flow through the state including, streams, rivers, lakes, drainage ditches, storm drains, ground water, and wetlands. Waters in sewage systems, treatment works or disposal systems, potable water distribution systems, and all water withdrawn for use until use and treatment are not considered state waters. BMPs can also minimize the need for corrective measures.

Erosion and Sediment Control Strategies

The best strategy is to address erosion control as the primary measure and sediment control as secondary measure. Erosion control reduces the amount of soil transported by runoff and wind as a result of construction disturbance. Sediment control captures the soil that has been eroded before it leaves the construction site. Effective implementation of erosion control BMPs will reduce maintenance and prevent potential sediment discharges.

Tips

- Phase construction activities to minimize the total amount of soil exposed.
- Use redundant BMPs in series to minimize overloading and prevent potential failures.
- Limiting erosion reduces stress on sediment control BMPs.
- Use both erosion and sediment control measures on project to prevent sediment discharges.
- Stabilize disturbed areas as soon as practical.

Maintain Your BMPs!

All erosion and sediment control practices and other protective measures identified in the SWMP must be maintained in effective operating condition at all times. Even though a project might be accepted and closed, the permits might still be open. Where BMPs have failed, they must be addressed as soon as possible, immediately in most cases, to minimize the discharge of pollutants.

How to Keep Our Waters Clean

- Prevent the discharge of pollutants into drainage systems, such as ditches, curbs and gutters, storm drain inlets, streams, rivers, and wetlands.

- Contain potential pollutants on the construction site.
- Protect clean off-site water from running on-site and becoming contaminated with sediment or other pollutants.
- Minimize the disturbance of existing vegetation.
- Stabilize disturbed areas as soon as possible.
- Inspections shall be conducted in accordance with Section 208.03. Inspections shall be recorded on CDOT Form 1388 for daily inspections and CDOT Form 1176 for 14 day inspections and after storm events.
- Inspect BMPs on inactive construction sites every 30 days and document the inspections until the stormwater permits are inactivated (closed).
- Repair any BMPs that have failed immediately.
- Keep stormwater documentation on the construction site (i.e., permit; SWMP and any updates to the plan in the Stormwater Notebook; and all inspection reports). SWMP changes shall be made immediately.
- Remove BMPs that are no longer necessary. For example, remove silt fence around an area that has achieved 70% of pre-existing vegetation.

The following items as approved by the Engineer are available for reference in the CDOT project field office:

- CDOT Specifications (Revised 5/2011)
- M & S Standard Plans (Revised 2/2011)
- CDOT Erosion Control and Stormwater Quality Guide (Revised 5/2011)
- Spill Prevention, Control, and Countermeasure Plan
- Copy of Biological Opinion, if available
- Permits

More Information on Best Management Practices

The specifications for BMPs included in a stormwater management plan are listed in CDOT's Standard Specifications for Road and Bridge Construction (Sections 101, 107.25, 208, 212, 213, 216 and any special provisions the project may have), CDOT M & S Standards M-208-1, and Stormwater Management Plan details. In addition, information on BMPs can be obtained from CDOT Erosion Control and Stormwater Quality Guide. All documents can be downloaded from:

<http://www.coloradodot.info/programs/environmental/water-quality/documents>

and CDOT Specifications at:

<http://www.coloradodot.info/business/designsupport/construction-specifications/2011-Specs>

Contact your supervisor, region water pollution control manager, or project engineer if you have any questions about the SWMP or the installation and maintenance of BMPs.

CDOT Standard Specifications for Road and Bridge Construction

Section 107.25 details practices that minimize water pollution during construction. This section also addresses who is responsible for any violations and fines. Section 208 details water quality control for construction sites. This section describes BMPs and penalties for failing to control erosion. Section 212 addresses seeding, fertilizer, soil conditioning and sodding requirements on construction sites. Section 213 details mulching and spray on mulch blanket

requirements. Section 216 addresses soil retention covering and spray on mulch blanket for erosion control on construction sites.

Ditches	
Slopes	
Chapter 1 Perimeter Control.....	1-0
Construction Safety Barrier Fencing	1-1
Temporary Berms and Diversions	1-2
Silt Fence	1-5
Vehicle Tracking Pad	1-8
Chapter 2 Exposed Areas	2-0
Surface Roughening	2-1
Mulching	2-2
Mulch Tackifier.....	2-4
Seeding.....	2-5
Soil Binders.....	2-7
Chapter 3 Slopes	3-0
Tracking.....	3-1
Silt Fence or Other Barriers.....	3-3
Soil Retention Blankets	3-5
Spray-on Mulch Blankets	3-11
Temporary Embankment Protector	3-12
Chapter 4 Ditches.....	4-0
Check Dam	4-1
Erosion Log Check Dam.....	4-2
Temporary Rock Check Dam	4-3
Silt Dike Check Dam	4-5
Silt Berm Check Dam.....	4-6
Soil Retention Blankets for Ditch Use	4-8
Chapter 5 Inlet/Outlet Protection.....	5-0

Inlet Protection	5-1
Erosion Logs	5-1
Erosion Bales	5-3
Inlet Storm Protection.....	5-4
Outlet Protection	5-6
Chapter 6 Sediment Traps/Basins	6-0
Temporary Sediment Traps and Basins.....	6-1
Permanent Basins used for Temporary BMP	6-5
Chapter 7 Pollution Prevention.....	7-0
Concrete Washout Structure	7-1
Construction Site Liquid & Solid Waste Management	7-5
Spill Prevention and Control	7-7
Clean Up Response Procedures	7-7
Stockpile Management	7-10
Street Sweeping and Vacuuming	7-12
Chapter 8 Special Conditions	8-0
Dewatering Structure.....	8-1
Stream Crossing	8-2
Chapter 9 Important Numbers.....	9-0
Contact Phone Numbers	9-1
Inspection Top 10.....	9-2

Chapter 1 **Perimeter Control**

Construction Safety Barrier Fencing	1-1
Berms and Diversions.....	1-2
Silt Fence	1-5
Vehicle Tracking Pad	1-8

Perimeter Controls

Perimeter controls are used to control sediment laden runoff from leaving a construction site and define the construction perimeter and/or sensitive areas. It is important that perimeter controls are in place before any earth-moving activities begin.

Construction Safety Barrier Fencing

Construction safety barrier fencing (orange fencing) should be used to protect wetlands and other sensitive areas from construction traffic.



This is an excellent example of construction safety barrier fencing. It is used here to prevent vehicles from damaging existing vegetation and minimize environmental impacts.

Temporary Berms and Diversions

A soil berm or diversion is a temporary compacted ridge that slows and diverts stormwater from an open traffic area or slope. Clean water diversions are designed to intercept and divert upland and clean runoff around bare soil areas. Berms and ditches diverting clean upland runoff around construction sites reduce erosion and sedimentation problems. Remove berms and ditches after construction.

Tips

- Berms shall have a minimum height of 18 inches, side slopes of 2:1 or flatter, and a minimum base width of 4.5 feet.
- Berms shall not be used in high-traffic areas where they will be continually run over.
- Do not run berms down a slope; watch for concentrated flows when the berm directs water to one area.
- Sand and gravel or debris laden material shall not be used to construct a berm.

Maintenance

- Repair and inspect often for breaches.



This is an excellent example of a soil berm. The soil is compacted and there are no breaks in the berm.



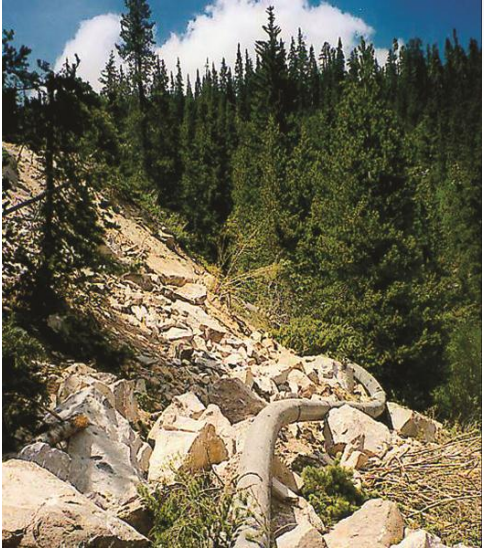

This is an excellent example of a clean water diversion pipe. The pipe should have a minimum capacity to convey the runoff expected from a 2-year frequency storm.



Poor example of a berm. The berm is not compacted.

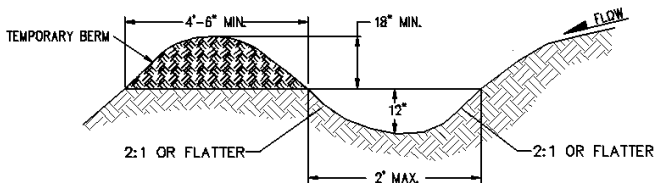

TEMPORARY DIVERSION

NOTES:

1. TEMPORARY DIVERSION DITCH SHALL BE CONSTRUCTED ACROSS THE SLOPE TO INTERCEPT RUNOFF AND DIRECT IT TO A STABLE OUTLET OR SEDIMENT TRAP.
2. USE IMMEDIATELY ABOVE A NEW CUT OR FILL SLOPE OR AROUND THE PERIMETER OF A DISTURBED AREA.
3. GRADIENT ALONG THE FLOW PATH SHALL HAVE A POSITIVE GRADE TO ASSURE DRAINAGE, BUT SHALL NOT BE SO STEEP AS TO RESULT IN EROSION DUE TO HIGH VELOCITY.

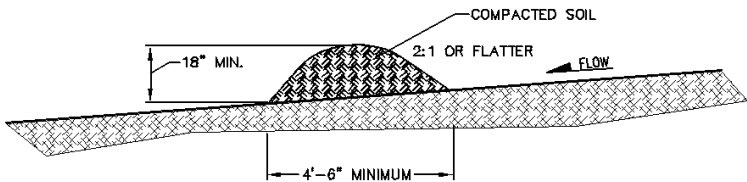

TEMPORARY BERM

NOTES:

1. BERMS SHALL HAVE A HEIGHT OF 18 INCHES, SIDE SLOPES OF 2:1 OR FLATTER AND A MINIMUM BASE WIDTH OF 4.5 FEET.
2. BERMS SHALL BE USED TO INTERCEPT AND DIVERT DRAINAGE TO A DESIGNATED OUTLET.
3. BERMS SHALL NOT BE USED WHERE DRAINAGE AREA EXCEEDS 10 ACRES.

Silt Fence

Silt fences are used as temporary perimeter controls around sites where construction activities will disturb the soil. They can also be used around the interior of the site, such as at the toe of slopes or piles of fill. A silt fence consists of a length of filter fabric stretched between anchoring posts spaced at regular intervals. When installed correctly and inspected frequently, silt fences can be an effective barrier to sediment leaving the site in stormwater runoff.

Tips

- Silt fence shall be installed prior to any grubbing or grading activity.
- Install silt fence along contours to avoid concentrated flows. Concentrated flows could cause silt fence failure.
- Along the toe of fills, install silt fence along a level contour and provide an area behind the fence for runoff to pond and sediment to settle. Silt fence should be installed approximately 5 feet away from the toe of the fill when feasible.
- Sediment shall be removed from behind the silt fence when it accumulates to one half the exposed filter fabric height and shall be disposed of properly.
- Repair rips and tears.
- Maximum drainage area is one-quarter acre per 100 feet of silt fence length.
- Do not place silt fence in or adjacent to existing wetlands where trenching could impact the wetlands. Construction safety barrier fencing (orange fencing) should be used to protect wetlands.
- Do not install silt fence in or across state waters.
- Silt fence does not work well in rocky soils or where high winds are prevalent.
- Do not install across ditches or areas of concentrated flows.

Maintenance

- Staple and stake as needed.
- Silt fences shall be removed when they have served their useful purpose.
- The area disturbed after the silt fence is removed shall be stabilized.



Very good installation of silt fence. Good perimeter control to define work area. Existing plants are protected with silt fence and safety barrier fence.



Poor maintenance of silt fence. Sediment should be removed from behind the silt fence when it accumulates to one half the exposed filter fabric height. Silt fence should not be installed in state waters.

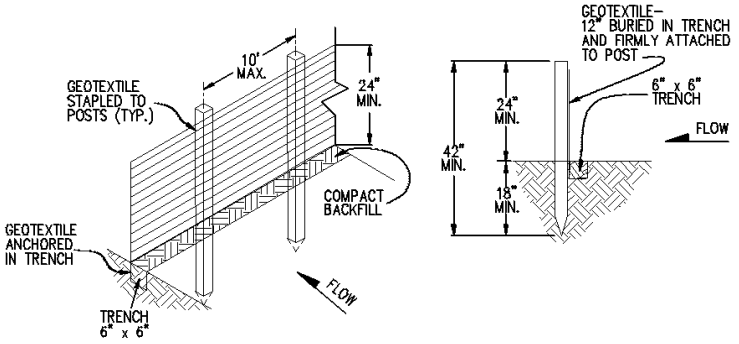

SILT FENCE

GEOTEXTILE SHALL BE ATTACHED TO WOOD POSTS WITH THREE OR MORE STAPLES PER POST.
STAPLES SHALL BE 1/2"
WOOD POST SHALL BE 1 1/2" x 1 1/2" NOMINAL.

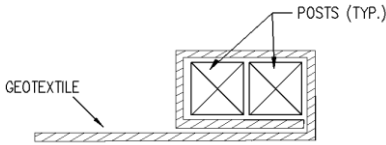

END SECTION DETAIL (PLAN VIEW)

GEOTEXTILE SHALL BE FOLDED AROUND TWO POSTS
ONE FULL TURN. SECURE GEOTEXTILE TO POST WITH THREE
STAPLES MINIMUM.

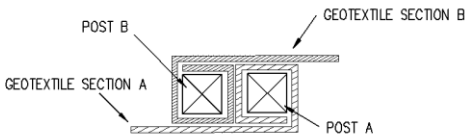

JOINING SECTION DETAIL (PLAN VIEW)

FOLD GEOTEXTILE AROUND EACH POST ONE FULL
TURN. SECURE GEOTEXTILE TO POST WITH THREE STAPLES
MINIMUM. POSTS SHALL BE TIGHTLY ABUTTED WITH NO GAPS
TO PREVENT POTENTIAL FLOW-THROUGH OF SEDIMENT AT JOINT.

Vehicle Tracking Pad

The purpose of a Vehicle Tracking Pad is to minimize the amount of sediment leaving the area as mud attached to vehicle tires. As a vehicle drives over the construction entrance BMP, it removes mud and sediment from the tires and reduces soil transport off the site. Geotextile fabric separates the gravel from the soil below, keeping the gravel from being ground into the soil. The geotextile fabric also reduces the amount of rutting caused by vehicle tires by spreading the vehicle's weight over an area larger than the tire width.

Tips

- Clean up mud or dirt tracked onto paved surfaces as needed.
- Damaged curb, gutter, or sidewalk should be replaced.
- Make sure all vehicles use the vehicle tracking pad.
- Replace and/or add aggregate as needed to prevent tracking mud and debris into the street.



An excellent installation of a Vehicle Tracking Pad and equipment access.





Poor installation of a Vehicle Tracking Pad. It is not 70 feet long. Refer to the table below for details.

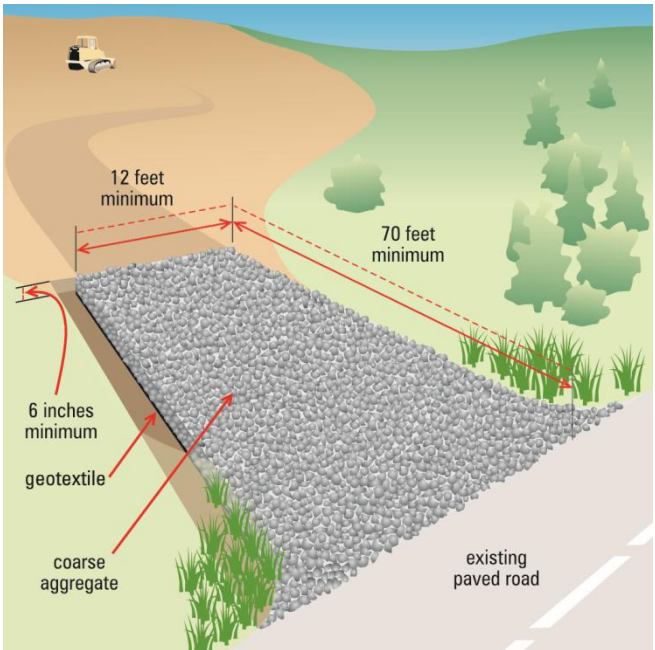

Vehicle Tracking Pad Aggregate Gradation Table

Sieve Size	Percent by Weight Passing Square Mesh Sieves
75 mm (3 inch)	100
50 mm (2 inch)	0-25
19 mm (¾ inch)	0-15

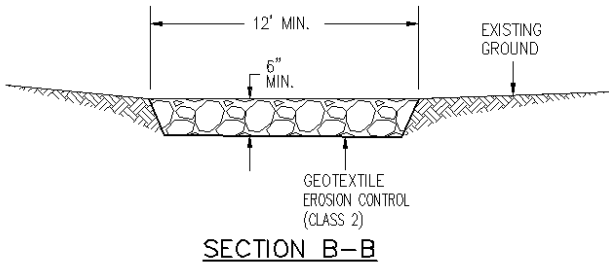
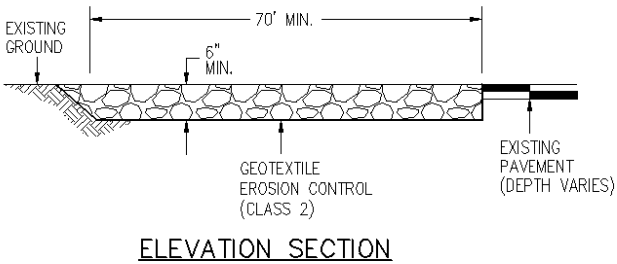
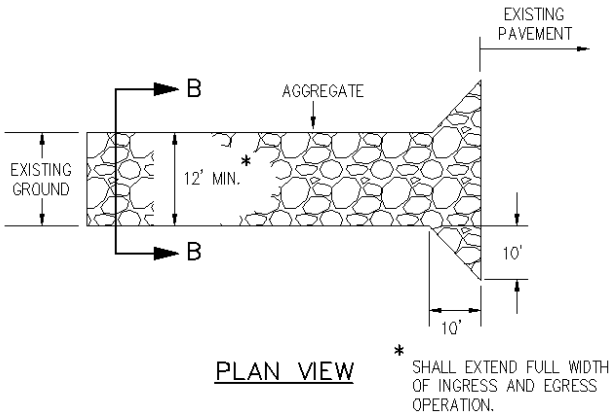

NOTES:

1. AGGREGATE FOR THE CONSTRUCTION ENTRANCE SHALL CONFORM TO SUBSECTION 208.02 (K).
2. THE CONTRACTOR SHALL PROTECT CURB AND GUTTER THAT CROSSES THE ENTRANCE FROM DAMAGE. PROTECTION OF THE CURB AND GUTTER WILL NOT BE PAID FOR SEPARATELY, BUT SHALL BE INCLUDED IN THE WORK.

VEHICLE TRACKING PAD

Chapter 2 Exposed Areas

- Surface Roughening 2-1
- Mulching 2-2
- Mulch Tackifier..... 2-4
- Seeding..... 2-5
- Soil Binders..... 2-7

Exposed Areas

According to CDOT Specifications, “the duration of the exposure of uncompleted construction to the elements shall be as short as practicable.”

Removing vegetation and topsoil can quickly result in erosion.

Surface Roughening

Surface roughening may be accomplished by furrowing, scarifying, ripping, or disking the soil to create a 2 to 4 inch variation in soil surface. Surface roughening is used as a temporary BMP to reduce the speed of runoff, increase infiltration, reduce erosion, traps sediment, and prepares the soil for seeding and planting by capturing moisture for seed.

Surface roughening should be used in conjunction with other BMPs such as mulching, seeding, or tackifier and should be along the contour of slopes. Surface roughening is different than tracking (See page 3-1).



Excellent example of surface roughening along the contour of the slope.

Mulching

Mulching is an erosion control practice that uses certified weed free hay or straw for temporary stabilization of slopes and exposed areas when seeding cannot occur due to seasonal constraints. Mulching can also be used for newly seeded areas.

Tips

- Mulch must cover the entire site with no bare areas and shall be applied within 4 hours of seeding.
- Mulch depth shall be between 1 and 2 inches.
- Hay at 1.5 tons per acre is preferred to straw at 2 tons per acre.
- Mulch shall be anchored by mechanically crimping the hay/straw followed by mulch tackifier.
- Mulch shall not be applied when windy conditions are present.



Excellent mulch application. Crimp forage mulch into loosened soil.



Excellent mulch application. Fibers should be crimped or disked into soil and should stand upright.



Poor mulch installation. Not enough mulch was applied and it was not anchored to the soil, which left bare areas.

Mulch Tackifier

Mulch tackifier applied to mulch stabilizes areas where vegetation cannot be established and provides immediate protection. It is also used to hold mulch in place and minimize erosion from runoff and wind. Always use mulch tackifier on mulched areas to hold mulch in place and prevent soil erosion caused by runoff and wind.

Tips

- Mulch tackifiers are water-soluble and must be reapplied 6 to 12 months after initial application if plants have not germinated and stabilized the soil.
- Mulch tackifier shall be applied within 4 hours of mulch applications.
- Do not apply during precipitation events, high winds, or over snow.



Good example of mulch tackifier application using a fan nozzle.

Seeding

Seeding is used to control runoff and erosion on disturbed areas by establishing vegetative cover. It reduces erosion and sediment loss and provides permanent stabilization.

Tips

- Prepare seed bed by loosening surface to a minimum depth of 4 inches.
- Perform all drill seeding operations along the slope's contour.
- Provide seed tags to inspector.
- Inspect seed drill to ensure proper operation and placement of seed.
- Mulch and mulch tackifier or blankets should be applied immediately, but no more than 4 hours after seeding.
- An area should be re-seeded if the seeded area fails to establish, provide adequate ground coverage, or becomes disturbed.
- Seeding should occur throughout the duration of the project as construction is completed.
- Seeding should only take place during the seeding seasons listed in the Seeding table. Seeding outside the seasonal constraints may cause seeding failures.

Prepare soil and, if required, incorporate topsoil or soil conditioning. Drill seed rows must be parallel to contours (along grade).



Seeding

Zone	Spring Seeding	Fall Seeding
<i>Areas other than the Western Slope</i>		
Below 6,000'	Spring thaw to June 1 st	September 15 th until consistent ground freeze
6,000' to 7,000'	Spring thaw to June 1 st	September 1 st until consistent ground freeze
7,000' to 8,000'	Spring thaw to July 15 th	August 1 st until consistent ground freeze
Above 8,000'	Spring thaw to consistent ground freeze	
<i>Western Slope</i>		
Below 6,000'	Spring thaw to May 1 st	August 1 st until consistent ground freeze
6,000' to 7,000'	Spring thaw to June 1 st	September 1 st until consistent ground freeze
Above 7,000'	Spring thaw to consistent ground freeze	

Soil Binders

Soil binders, also known as chemical stabilizers, provide temporary soil stabilization. Soil binders are sprayed onto the surface of exposed soils to hold the soil in place and minimize erosion from runoff and wind. Soil binders, in combination with hydro-mulches, are used to temporarily stabilize soils in stockpiles, berms, or when slopes cannot be seeded due to seasonal constraints. These materials can stabilize areas where vegetation cannot be established and provide immediate protection.

Tips

- Apply soil binder over roughened soil surface.
- Rill erosion indicates poor product mixture and/or application.
- Reapply at least every 6 to 12 months or after the surface has been disturbed again.
- Use soil binders on stockpiles to reduce wind erosion.
- Do not use in areas with vehicular traffic. Once the surface is broken, the soil binder must be reapplied.

Chapter 3 Slopes

Tracking.....	3-1
Silt Fence or Other Barriers.....	3-3
Soil Retention Blankets	3-5
Spray-on Mulch Blankets	3-11
Temporary Embankment Protector	3-12

Slopes

Slopes—especially steep and/or long ones—must be protected to prevent sheet, rill, and gully erosion. Slopes should be stabilized immediately after grading work is completed. Soil retention blankets are needed on most slopes steeper than 3:1; depending on soil types. Protecting slopes from erosion requires several actions that must be taken together. No single approach will be successful, especially if the slope is long, steep, or has highly erodible soils.

If slopes are broken up into benches or steps, runoff can be collected and diverted to channels that lead to a pipe or to open channel embankment protectors that have stable outlets.

Combine the following BMPs with seeding and mulching to protect slopes. See the Seeding and Mulching BMPs in the Exposed Areas chapter for details and tips.

Tracking

Tracking involves roughening a bare soil with horizontal grooves using construction equipment. Tracking reduces runoff velocity, increases infiltration, and reduces erosion. Tracking works best when used in conjunction with other BMPs such as mulching, seeding, or mulch tackifier.



Tips

- Track the slope when grading work is completed.
- Track up and down the slope.
- Tracking does not work well in sandy soils.

Tread-track slopes up and down hill to improve stability.

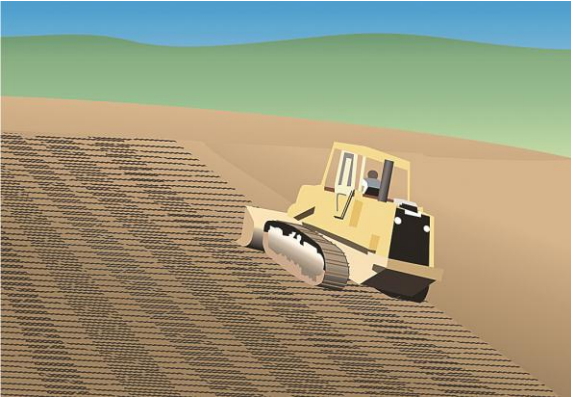

Excellent example of tracking. Tracks are perpendicular to slope.

Silt Fence or Other Barriers

Silt fence or other barriers should be installed approximately 5 to 10 feet from the toe of the slope or slightly away from the toe, and every 75 to 125 feet apart on long slopes. Stagger fence sections to ensure total coverage. Repair as needed, and remove when grass is well established. Erosion logs, installed on the contour, may also work very well to break up flows on long slopes.

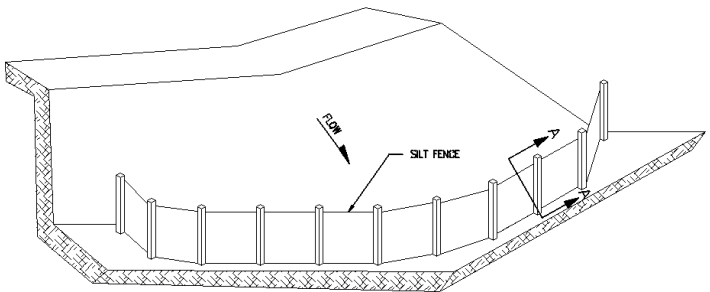

ISOMETRIC VIEW

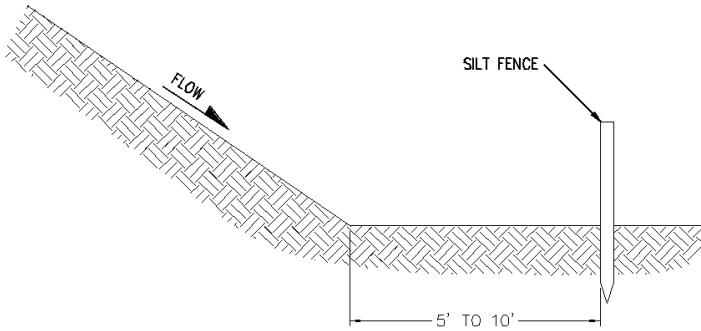

SECTION A-A

TOE OF SLOPE PROTECTION

NOTES

1. SILT FENCE SHALL HAVE A MAXIMUM DRAINAGE AREA OF ONE-QUARTER ACRE PER 100 FEET OF SILT FENCE LENGTH; MAXIMUM SLOPE LENGTH BEHIND BARRIER IS 100 FEET; MAXIMUM GRADIENT BEHIND THE BARRIER IS 2:1.
2. SILT FENCE USED AT TOE OF SLOPE SHALL BE PLACED 5 TO 10 FEET BEYOND TOE OF SLOPE TO PROVIDE STORAGE CAPACITY.
3. SILT FENCE SHALL BE PLACED ON THE CONTOUR, WITH ENDS FLARED UP SLOPE.

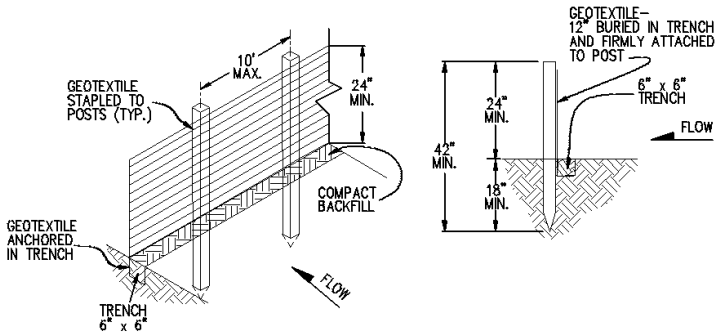

SILT FENCE

GEOTEXTILE SHALL BE ATTACHED TO WOOD POSTS WITH THREE OR MORE STAPLES PER POST.
 STAPLES SHALL BE 1/2"
 WOOD POST SHALL BE 1 1/2" X 1 1/2" NOMINAL.

Soil Retention Blankets

Steep slopes shall be protected with soil retention blankets. Soil retention blankets are placed on the soil in disturbed areas to control erosion, retain sediment resulting from sheet-flow runoff, and protect newly seeded areas. When properly applied, soil retention blankets completely cover the ground surface. Blanket type is detailed in the Slope Treatment table.

Tips

- The disturbed area shall be uniform, with no large rocks, vegetation or rilling on the surface, before placing blankets.
- Areas where blankets are to be used shall be properly prepared with topsoil or soil conditioning, and fertilized if required, and seeded before the blankets are placed.
- The blankets shall be placed smoothly but loosely on the soil surface without stretching.
- Re-anchor loosened matting and replace missing matting and staples as required.
- Blankets at the top and bottom of the slope shall be trenched in 6 inches wide by 6 inches deep.
- Staple checks are required every 35 feet down the slope.
- Trenching at the top of the slope should be beyond the crest of the slope to avoid undercutting (see Section 216 and M-208).

Slope Treatment

Condition	Blanket Type
Slopes 2:1 or steeper depending on soil type	Soil Retention Blanket
Erosive soil (sand) or slopes receiving sheet flow from roadway surface runoff	Soil Retention Blanket Turf Reinforcement Mat

CDOT Landscape Architects can provide more information on the appropriate types of soil retention blankets.

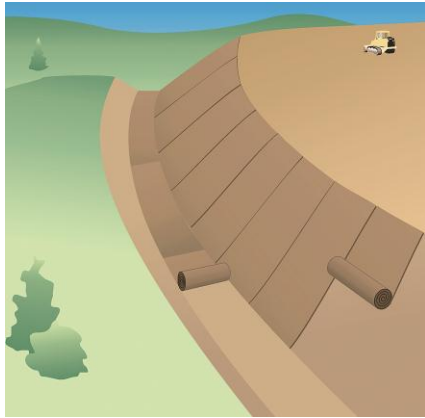

Steep, long slopes need blankets. Install blankets up and down long slopes. For channels below slopes, install horizontally. Don't forget to apply seed and fertilizer (if necessary) before installing blankets. Overlap the edges of abutting blankets and anchor the overlap.



Excellent installation of soil retention blankets. Remember to entrench the blanket at the top and bottom of the slope. Staple checks are required every 35 feet.



Poor installation of soil retention blankets. Blankets should have been staked down and overlapped, and should fully cover the disturbed area.

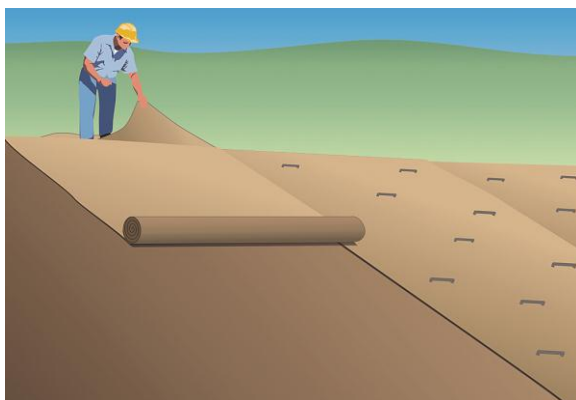

Install blankets vertically on long slopes. Unroll from top of hill, staple as you unroll it. Do not stretch blankets.

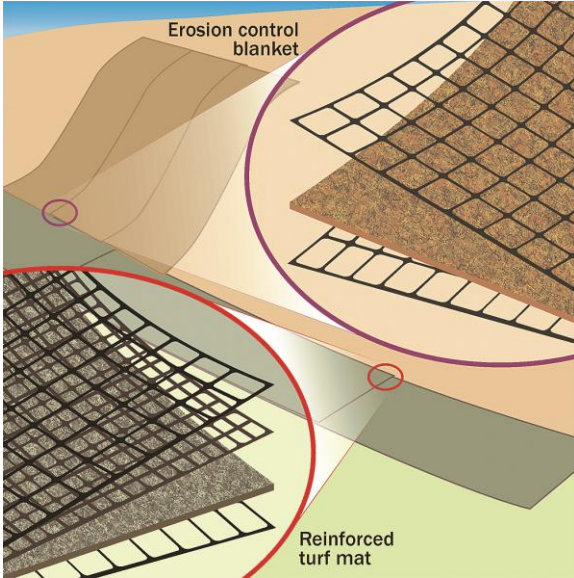

Contact a CDOT Landscape Architect to determine the type of blanket that should be used on the project. Remember to prepare soil, apply topsoil or soil conditioning, if required, and seed prior to placing the blanket.

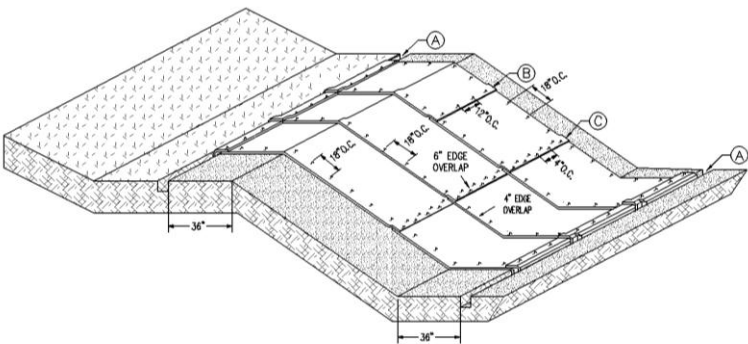

SOIL RETENTION BLANKETS/TURF REINFORCEMENT MATS (TRM)
SLOPE APPLICATION

APPLY SEED AND ANY REQUIRED SOIL
CONDITIONERS PRIOR TO COVERING
COMPACTED SOIL WITH BLANKET

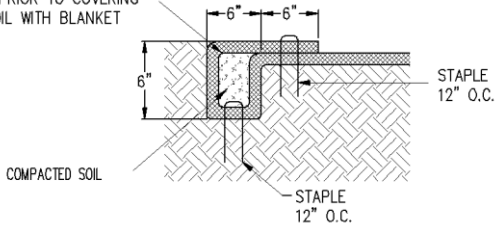

ANCHOR TRENCH SECTION A

TO BE USED AT THE BEGINNING AND END
OF THE CHANNEL ACROSS IT'S ENTIRE WIDTH.

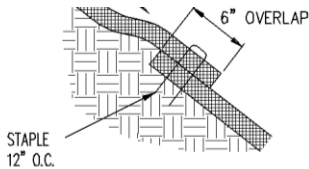

CONSECUTIVE ROLL OVERLAP SECTION B

TO BE USED WHEREVER ONE ROLL OF BLANKET ENDS
AND ANOTHER BEGINS WITH THE UPHILL BLANKET
PLACED ON TOP OF THE BLANKET ON THE DOWNHILL SIDE.

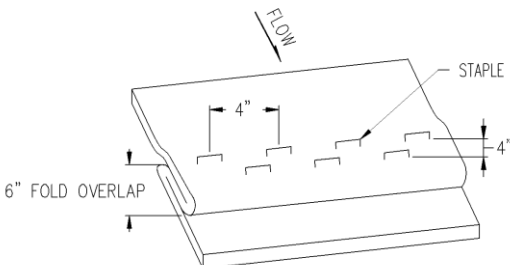

STAPLE CHECK SECTION C

TO BE USED ON SLOPE EVERY 35 FEET.

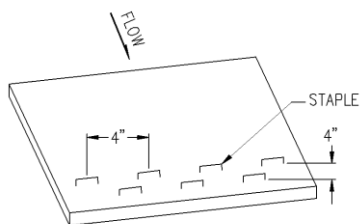

DOWNSLOPE END STAPLE CHECK

TO BE USED WHEN SLOPE RUNS INTO A RECEIVING WATER
AND CANNOT BE EXTENDED 3 FEET BEYOND SLOPE.

Spray-on Mulch Blankets

Spray-on mulch blanket consists of fibers bound together by adhesives and photodegradable synthetic fiber. The fibers are colored yellow or green to help the operator insure coverage and apply the material uniformly. **A sample product shall be submitted to Project Engineer at least 2 weeks prior to use on the project.**

A technical representative or authorized distributor shall be present for initial mixing and application of product.

Tips

- Mix rate of 50 lbs. of spray-on mulch to 125 gallons of water.
- Seed shall not be added to mixture.
- Apply mixture in an even layer working from side to side, top to bottom.
- Application rate shall be 2600 lbs. per acre.
- Spray-on mulch blanket shall have no cure time.
- Do not apply in ditches or areas of concentrated flows.



Poor example of spray-on blanket. Notice the uneven coverage and holes or uncovered areas.

Temporary Embankment Protector

A temporary embankment protector, also called a temporary slope drain, is a flexible conduit for stormwater that extends down the length of a disturbed slope to divert stormwater and serve as a short-term outlet. Embankment protectors convey runoff without causing erosion on or at the bottom of the slope and are used during grading operations until the permanent drainage structure is installed or final stabilization has occurred on the slope. Temporary embankment protectors are often used in conjunction with diversion berms to direct runoff to the slope drain.

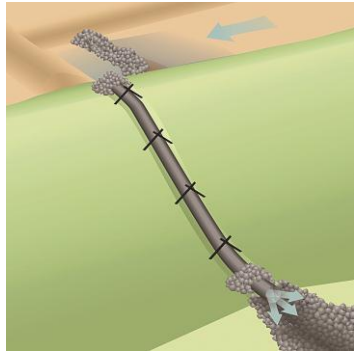

Tips

- Only for temporary use.
- Pipe shall be at least 12" flexible pipe.
- The pipe shall be securely fastened together, have water-tight fittings, and be securely anchored to the slope.
- Direct runoff into pipe using end section or berm.
- Continue pipe beyond toe of slope.
- Erosion Control, riprap scour pad or protection, is required at pipe outlet.
- Embankment protectors shall be inspected for erosion and accumulation of debris at the inlet and outlet after each significant rainfall. Open chute protectors should be inspected for undercutting. If outlet protection is not shown in the plans, contact a CDOT Hydraulic Engineer for additional information.

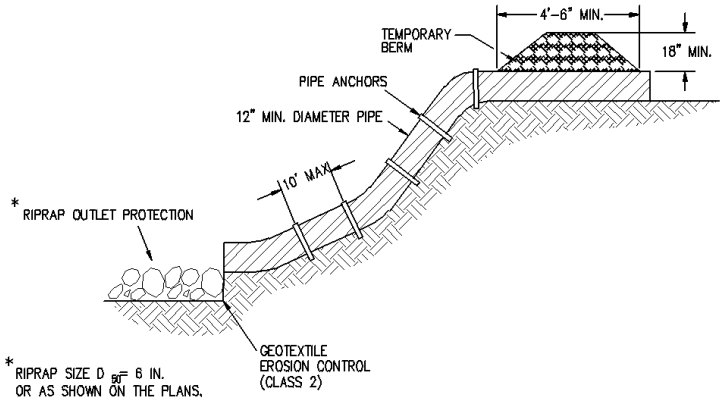

TEMPORARY SLOPE DRAIN

ANCHOR SIZE VARIES ACCORDING TO PIPE SIZE.

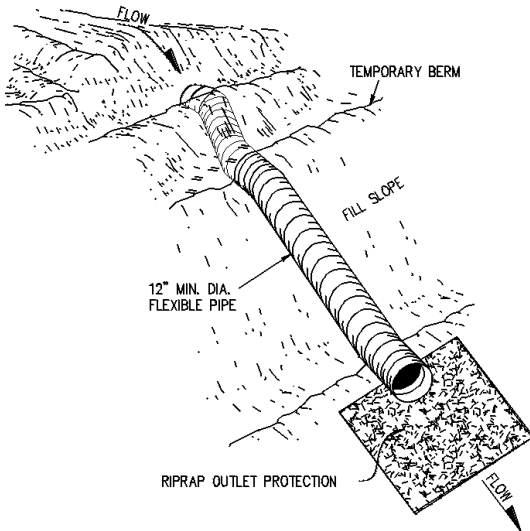



Notice how the slope has eroded. An example of an appropriate place for an embankment protector.

Chapter 4 **Ditches**

Check Dam	4-1
Erosion Log Check Dam	4-2
Temporary Rock Check Dam	4-3
Silt Dike Check Dam	4-5
Silt Berm Check Dam	4-6
Soil Retention Blankets for Ditch Use	4-8

Ditches

Drainage ditches need check dams to reduce the speed of water and capture sediment. Soil retention blankets can also be used in ditches to reduce the speed of water and prevent erosion of the ditch. Seed ditches and install check dams before excavating, filling, or grading uphill areas. Remove temporary check dams after the site has been stabilized and vegetated.

Check Dam

Check dams are relatively small, structures constructed across a ditch. As stormwater runoff flows through the structure, the check dam catches sediment from the channel itself or from the contributing drainage area. Check dams are typically constructed out of erosion bales, erosion logs, rock, silt dikes, or silt berms. They are most effective when used with other stormwater, erosion, and sediment-control measures. Temporary check dams should be removed when their useful life has been completed. In the case of grass-lined ditches, check dams should be removed when the grass has matured sufficiently to protect the ditch or swale from erosion. The area beneath the check dams should be seeded and mulched immediately after the check dams are removed.

Sediment should be removed and properly disposed of when it has accumulated to one-half of the original height of the check dam. Inspect for erosion along the ends of the check dams and repair immediately when necessary.

Erosion Log Check Dam

Tips

- Embed erosion log 2 inches into soil and ensure contact with the ground for its entire length.
- Erosion logs can be placed on top of soil retention blankets to help reduce water velocity.
- Proper staking is essential for erosion log function.
- Diameter of the erosion log is specified in the Stormwater Management Plan.

NOTES

1. EROSION LOGS SHALL BE EMBEDDED 2 INCHES INTO THE SOIL.
2. STAKES SHALL BE EMBEDDED TO A MINIMUM DEPTH OF 12 INCHES.
3. EROSION LOGS SHALL BE TIGHTLY ABUTTED WITH NO GAPS.

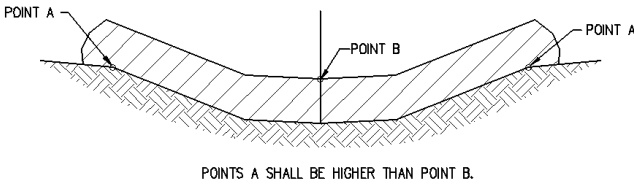
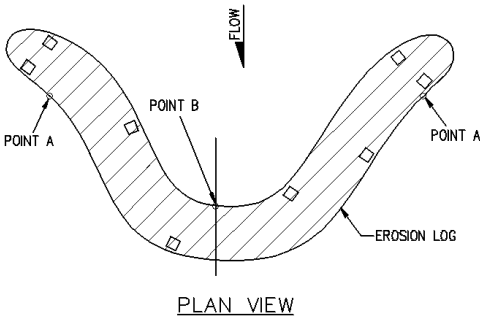

ELEVATION

EROSION LOG DITCH INSTALLATION

Temporary Rock Check Dam

Tips

- A 2-year or larger storm should safely flow over the check dam without an increase in upstream flooding or destruction of the check dam.
- The height of the check dam at the center shall be 2 feet. The check dam shall be wide enough to reach from bank to bank of the ditch or swale. Geotextile fabric below the rock is essential for proper function. Riprap size is detailed in the design. If riprap size is not part of the design, contact a CDOT Hydraulic Engineer.
- Check dam shall be constructed with a low point or controlled release point.
- Key check dam into ditch.
- As a general rule, the maximum spacing between dams should be such that the toe of the upstream check dam is at the same elevation as the controlled release point of the downstream dam.
- Do not install check dams in state waters.



Excellent installation of rock check dams.

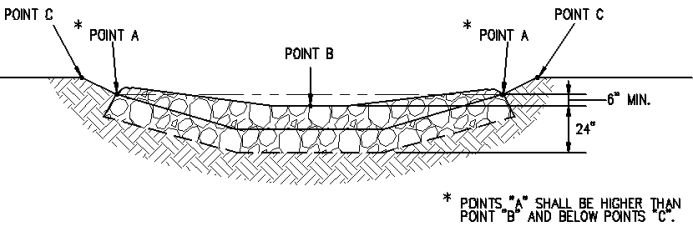

TYPICAL SECTION VIEW

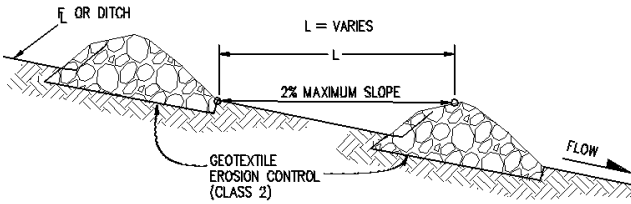

SECTION VIEW ALONG DITCH FLOWLINE

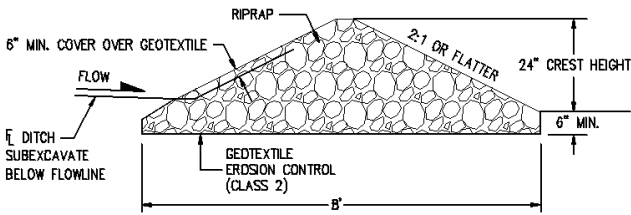

SECTION DETAIL

Silt Dike Check Dam



An excellent installation of a silt dike check dam.



Poor installation and maintenance of a silt dike check dam. Accumulated sediment should be removed and the right side of the dike should be extended up the slope.

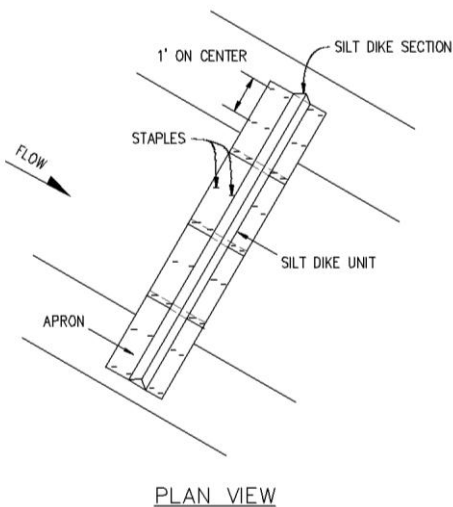

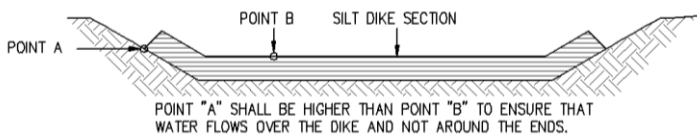

PLAN VIEW

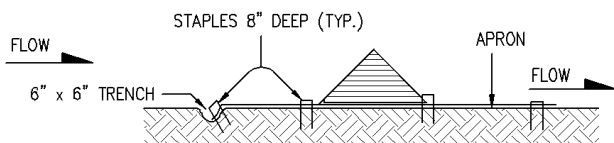

TYPICAL SECTION

NOTES:

1. ANCHOR APRON INTO TRENCH WITH 8" MINIMUM STAPLES PLACED AT 1.5' INTERVALS ALONG EDGE.
2. FILL AND COMPACT TRENCH.
3. THE APRON SHALL EXTEND A MINIMUM OF 2 FEET BEYOND EACH SIDE OF THE TRIANGLE.

Silt Berm Check Dam



Excellent installation of a silt berm check dam.

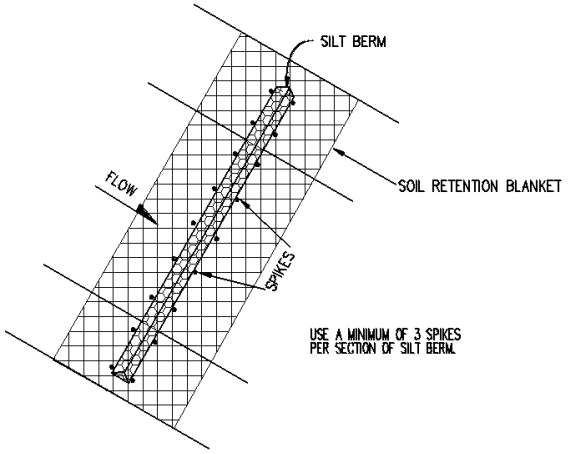

PLAN VIEW

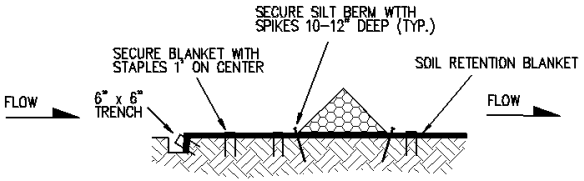

TYPICAL SECTION VIEW

NOTES:

1. ANCHOR SOIL RETENTION BLANKET INTO TRENCH WITH 8" MINIMUM STAPLES PLACED AT 1.5' INTERVALS ALONG EDGE.
2. FILL AND COMPACT TRENCH.
3. SECTIONS OF THE SILT BERM SHALL BE OVERLAPPED WITH NO GAPS.

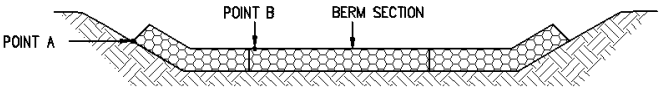

POINT "A" SHALL BE HIGHER THAN POINT "B" TO ENSURE THAT WATER FLOWS OVER THE BERM AND NOT AROUND THE ENDS.

FRONT VIEW

SILT BERM-VELOCITY CHECKS

Soil Retention Blankets for Ditch Use

Drainage ditches convey stormwater runoff through a stable conduit. Vegetation lining the ditch slows down concentrated runoff. Because grassed channels are not usually designed to control peak runoff loads by themselves, they are often used with additional BMPs, such as check dams or silt dikes. If the drainage ditch is over 2 percent grade, contact a CDOT Landscape Architect for recommendations on blanket type. Refer to Soil Retention Blankets in the Slopes chapter for more details on installation and use.

Tips

- Lay in blankets similar to roof shingles; start at the lowest part of the ditch, then work your way up. Uphill pieces lap over downhill sections. Staple through both layers around edges at the overlap.
- Trench, tuck, and tamp down ends at the top of the slope. Do not stretch blankets or mats.
- Avoid creating “v” shaped ditches. Construct “u” or trapezoidal shape.

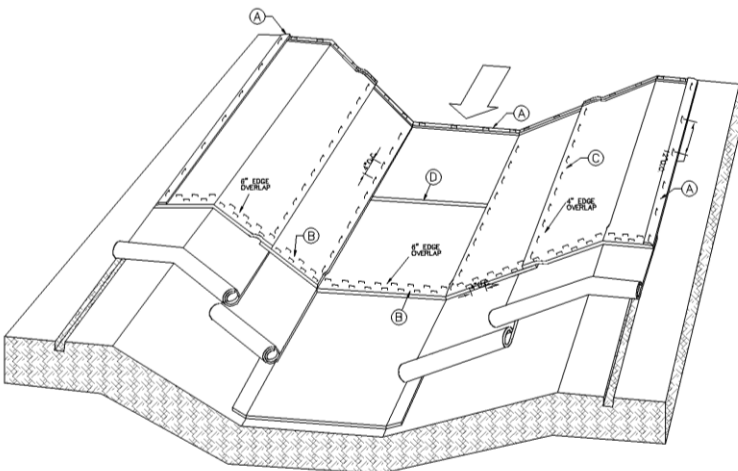

SOIL RETENTION BLANKETS/TURF REINFORCEMENT MATS (TRM)
CHANNEL APPLICATION
IN ACCORDANCE WITH SECTION 216.

APPLY SEED AND ANY REQUIRED SOIL CONDITIONERS PRIOR TO COVERING COMPACTED SOIL WITH BLANKET

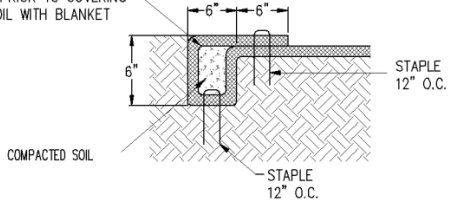

**ANCHOR TRENCH
SECTION A**

TO BE USED AT THE BEGINNING AND END OF THE CHANNEL ACROSS IT'S ENTIRE WIDTH.

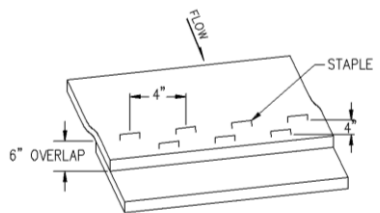

**CONSECUTIVE ROLL OVERLAP
SECTION B**

TO BE USED WHEREVER ONE ROLL OF BLANKET ENDS AND ANOTHER BEGINS WITH UPSTREAM BLANKET PLACED ON TOP OF THE BLANKET ON THE DOWNSTREAM SIDE.

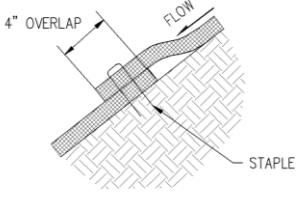

**SIDE SEAM OVERLAP
SECTION C**

TO BE USED FOR OVERLAP WHEN 2 WIDTHS OF BLANKET ARE APPLIED SIDE BY SIDE WITH THE UPHILL BLANKET PLACED ON TOP OF THE BLANKET ON THE DOWNHILL SIDE.

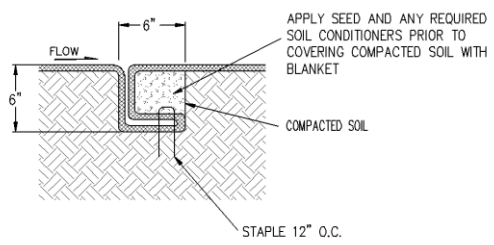

**CHANNEL CHECK SLOT
SECTION D**

TO BE USED AT 30' INTERVALS IN CHANNEL FLOWLINE.

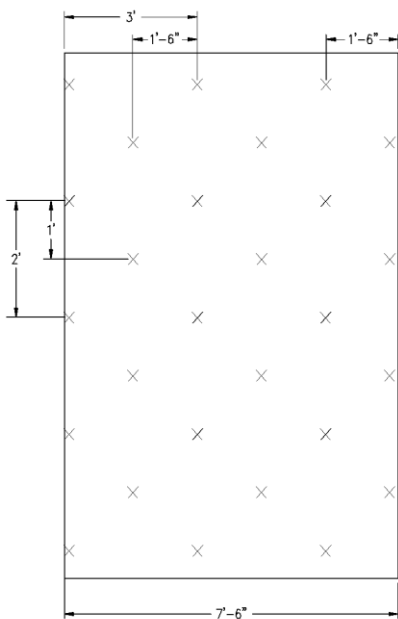

TYPICAL STAPLE PATTERN
FOR CHANNEL APPLICATION

SEE SUBSECTION 216.05.

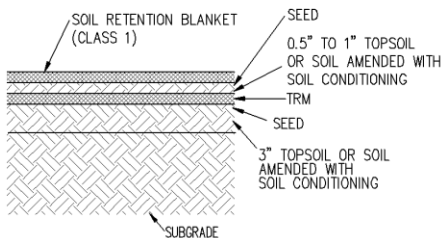

SOIL FILLED TRM APPLICATION

1. PLACE 3" TOPSOIL OR SOIL AMENDED WITH SOIL CONDITIONING.
2. APPLY SEED AND RAKE INTO SOIL.
3. INSTALL TRM.
4. PLACE 0.5" TO 1" TOPSOIL OR SOIL AMENDED WITH SOIL CONDITIONING.
5. APPLY SEED AND RAKE INTO SOIL.
6. INSTALL SOIL RETENTION BLANKET (CLASS 1).

Chapter 5 Inlet/Outlet Protection

- Inlet Protection 5-1
- Erosion Logs 5-1
- Erosion Bales 5-3
- Inlet Storm Protection..... 5-4
- Outlet Protection 5-6

Inlet and Outlet Protection

Culverts and ditches are designed to carry moderate to large amounts of stormwater. They also can carry a lot of sediment to streams, rivers, wetlands, lakes and sensitive areas if they are not properly protected. Culvert and swale outlets can become severely eroded if fast stormwater flows are not controlled.

Inlet Protection

Storm drain inlet protection measures prevent sediment and debris from entering storm drain inlets. Inlet protection is implemented at existing inlets prior to construction, but new inlets are protected as they are installed and brought on-line. Inlets can be protected with erosion logs, erosion bales, or other sediment control devices. Place inlet protection prior to milling operations, or other activities when debris may enter storm drain inlets.

Erosion Logs

Tips

- Place logs around the top of inlets to prevent sediment from falling in the flow line from above.



Bad installation of erosion logs. Stormwater is by passing the erosion log.



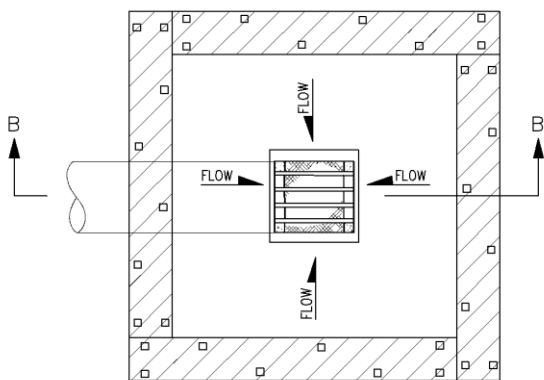

PLAN VIEW

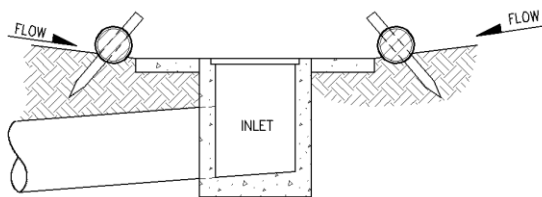

SECTION B-B

NOTE: LOCATE EROSION LOGS AT THE OUTSIDE
EDGE OF THE CONCRETE APRON.

EROSION LOG FILTER AT DROP INLET

Erosion Bales

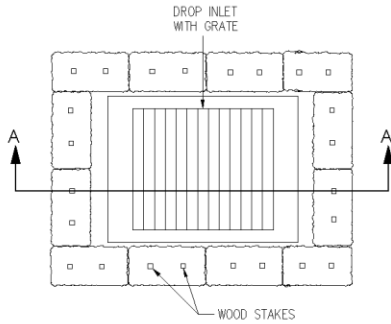

PLAN VIEW

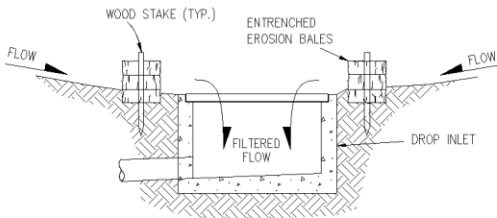

SECTION A-A

EROSION BALE FILTER AT DROP INLET

NOTES

1. STAKES SHALL BE WOOD AND SHALL BE 2" X 2" NOMINAL.
2. EROSION BALES SHALL BE 18" X 18" X 36".
3. EROSION BALES SHALL BE ENTRENCHED 4 IN. MINIMUM INTO THE SOIL, TIGHTLY ABUTTED WITH NO GAPS, STAKED, AND BACKFILLED AROUND THE ENTIRE OUTSIDE PERIMETER.



Good installation of inlet protection with silt fence and erosion bales. Use erosion bales only if the area adjacent to the inlet consists of soil.



Inlet Storm Protection

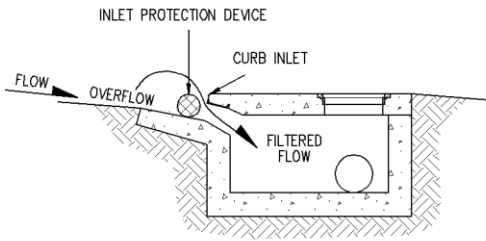
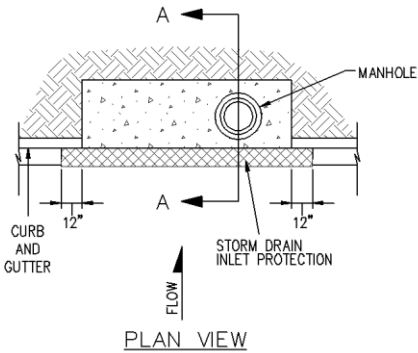
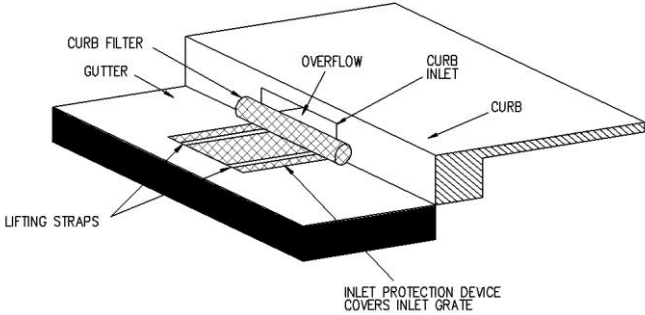

STORM DRAIN INLET PROTECTION (TYPE I)
INLET PROTECTION SHALL EXTEND 12 IN. PAST EACH END OF THE INLET.

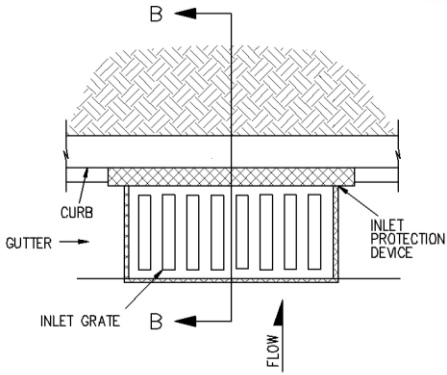

PLAN VIEW

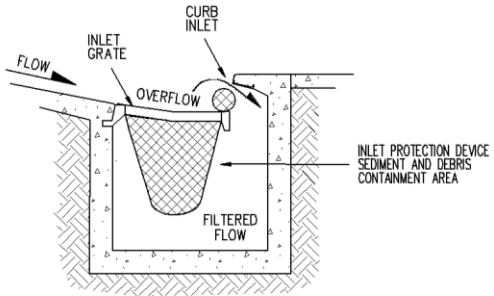

SECTION B-B

STORM DRAIN INLET PROTECTION (TYPE II)



Poor inlet protection. The sock does not extend 1 foot past each end of the inlet.

Outlet Protection

Outlet protection prevents scour and erosion at the outlet of a channel or conduit by reducing the speed of stormwater. Outlet protection is comprised of geotextile fabric and riprap placed at the outlet.

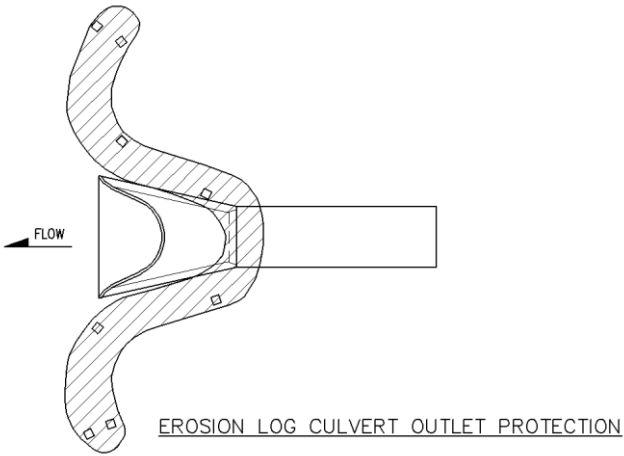

Good use of rock as outlet protection. The erosion log above the culvert helps prevent debris and dirt from falling into the outlet.



Poor installation of outlet protection. Geotextile was not placed under the riprap and not enough rock was used. As a result, stormwater is undercutting the existing rock.

Chapter 6 Sediment Traps/Basins

Temporary Sediment Traps and Basins..... 6-1
Permanent Basins used for Temporary BMP 6-5

Temporary Sediment Traps and Basins

Sediment traps and basins are small impoundments that allow sediment to settle out of stormwater runoff. Sediment traps are usually used for areas draining 5 acres or less and sediment basins are used for areas draining 5 acres or more. Traps and basins should not be located closer than 20 feet from a proposed building foundation or highway alignment.

A permanent detention pond can be used as temporary sediment trap/basin if:

- It is marked on SWMP as a temporary BMP.
- The pond is inspected and maintained in accordance with the Stormwater-Construction Permit.
- The pond is designed and implemented in accordance with good engineering, hydraulic and pollution control practices.

Tips

- Temporary sediment traps and basins shall be installed before any land disturbance takes place in the drainage area.
- Sediment shall be removed from the trap and basin when the wet storage volume has been reduced by one half.
- The outlet of a trap shall be underlain with geotextile fabric and be at least 1 foot high.
- The slope on the outlet shall be no steeper than 2:1.
- Sediment trap outlets shall be riprap $D_{50} = 12$ inch.
- Sediment traps shall only be dug down to a maximum of 4 feet, should not be installed in state waters, and should not mix with ground water.



Sediment basins often have pipe risers, but well-constructed rock overflow outlet notches in the dam or retaining berm are acceptable if the overflow area is protected from erosion.

Float Skimmers

Float Skimmers rest on the surface of the pond and pump water out of the pond. The skimmer allows sediment to settle to the bottom of the pond while drawing clean runoff from the surface. They work best for catchment basins collecting three quarters of an acre or less.

Tips

- Basin length to width ratio should be 2:1.
- Place pump opposite of inflow.
- Baffles should be used to prevent damage caused from large debris.
- Skimmer outfall requires erosion protection.

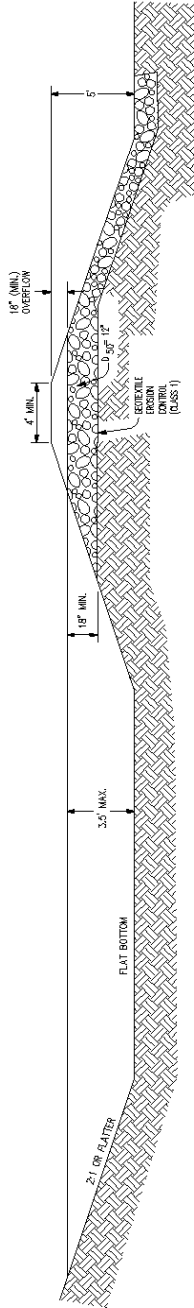

SECTION A-A

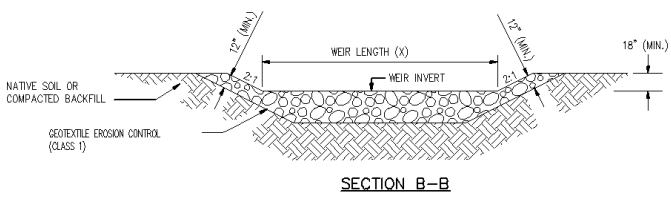
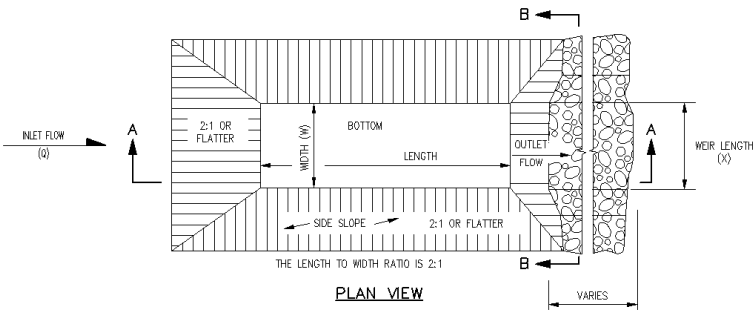

NOTES

1. THE MAXIMUM DRAINAGE AREA IS 5 ACRES.
2. THE MAXIMUM STRUCTURE LIFE IS 2 YEARS.
3. THE STORAGE AREA IS 1800 CUBIC FEET PER ACRE.
4. THE MAXIMUM EMBANKMENT HEIGHT SHALL BE 5 FT. MEASURED ON THE DOWNSTREAM SIDE.
5. THE LENGTH/WIDTH RATIO MAY BE ADJUSTED TO MEET SITE CONDITIONS WHEN APPROVED BY THE ENGINEER.
6. WIDTH (W) OF SEDIMENT TRAP IS APPROXIMATELY EQUAL TO THE WEIR LENGTH (X).
7. SEDIMENT TRAP DESIGN SHALL BE APPROVED BY THE ENGINEER.

WEIR LENGTH TABLE

DRAINAGE AREA (ACRES)	WEIR LENGTH (FEET)
1	4
2	6
3	8
4	10
5	12

Permanent Basins used for Temporary BMP

Permanent detention ponds shown in the construction plans may be used as temporary BMPs if:

- The pond is designated as a construction BMP in the SWMP.
- The pond outlet is protected with Erosion Bales, Erosion Logs, and/or Silt Fence.
- The pond is designed and implemented for use as a BMP during construction in accordance with good engineering, hydrologic, and pollution control practices.
- The pond is inspected and maintained.
- All silt and debris shall be removed and the pond returned to the design grade and contour prior to project acceptance.



Poor installation of a sediment basin outlet protection. Outlet plate should be protected to prevent damage and release of sediment laden water.

Chapter 7 **Pollution Prevention**

- Concrete Washout Structure 7-1
- Construction Site Liquid & Solid Waste Management 7-5
- Spill Prevention and Control 7-7
- Clean Up Response Procedures 7-7
- Stockpile Management 7-10
- Street Sweeping and Vacuuming 7-12

Pollution Prevention

Concrete Washout Structure

Concrete washout structures are used to contain concrete and concrete waste water when the chutes of concrete mixers and hoppers of concrete pumps are rinsed out after delivery. The washout facilities can be constructed or ready-made. All washout facilities consolidate solids for easier disposal and prevent runoff of concrete waste water.

The wash water is alkaline and contains high levels of chromium, which can leach into the ground and contaminate groundwater. It can also migrate to a storm drain, which can increase the pH of nearby waterways and harm aquatic life.

Tips

- It is recommended that facilities be cleaned out once they are 2/3 full, or new facilities shall be constructed to provide additional concrete waste storage.
- Adding solvents, flocculents, or acid to washwater is prohibited.
- The washout shall be located no less than 50 feet horizontally away from state waters.
- Do not place concrete washouts in low areas or ditches.
- Permanent disposal of concrete washout waste on the construction site is prohibited.

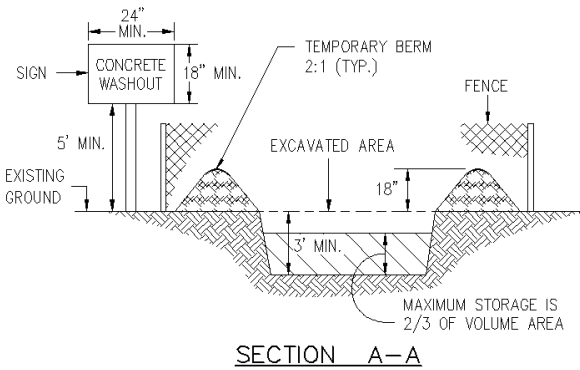
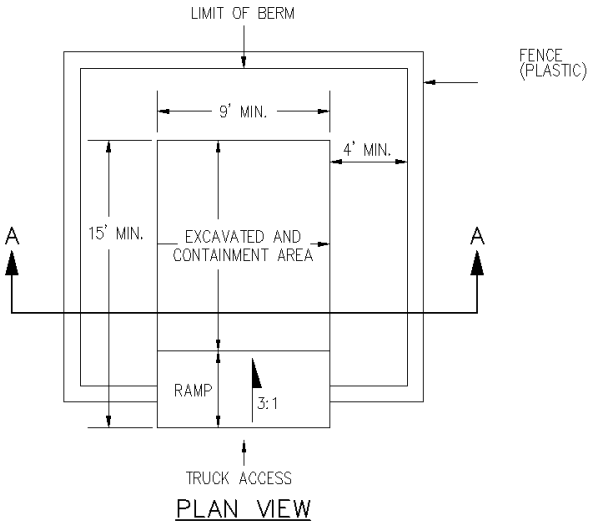

NOTES:

1. EROSION BALES MAY BE USED AS AN ALTERNATIVE FOR THE BERM.
2. A FENCE (PLASTIC) CONFORMING TO SUBSECTION 607.02 SHALL BE INSTALLED AROUND THE CONCRETE WASHOUT AREA, EXCEPT AT THE OPENING.
3. THE CONCRETE WASHOUT SIGN SHALL HAVE LETTERS AT LEAST 3 INCHES HIGH AND CONFORM TO SUBSECTION 630.02.



Concrete waste shall be placed in a temporary concrete washout facility located a minimum of 50 feet from state waters, drainageways, and inlets.



Concrete wash water is alkaline and contains high levels of chromium, which can leach into the ground and contaminate groundwater. It can also migrate to a storm drain, which can increase the pH of area waters and harm aquatic life. Concrete washout should only be disposed of in a properly labeled concrete washout facility.



Excellent installation of an above ground concrete washout structure.

Construction Site Liquid & Solid Waste Management

Building materials and other construction site wastes, including sanitary wastes, must be properly managed and disposed of to reduce the potential from pollution.

Practices such as trash disposal, recycling, proper maintenance of sanitary facilities, and spill prevention and cleanup measures can reduce the potential for stormwater runoff to mobilize construction site wastes and contaminate surface or ground water.



Poor placement of a temporary sanitary facility. Temporary sanitary facilities should be located 50 feet horizontally away from state waters, drainageways, inlets, receiving waters, areas of high traffic, and areas susceptible to flooding. Wastewater generated from sanitary facilities shall not be allowed to flow into storm sewers and drainageways. Only licensed haulers shall be authorized to dispose of waste. Facilities shall be secured to prevent overturning in areas susceptible to strong winds.



Waste shall be segregated properly into various categories such as hazardous materials, toxic liquids, non-hazardous materials, and recyclable materials. Proper disposal is required for each by-product category.



Containers of liquids should have secondary containment and be stored away from drainageways, inlets, receiving waters, areas of high traffic, and areas susceptible to flooding. Containers also should be properly labeled.



Poor placement of containers of liquid. The secondary containment BMP should hold 110% of the volume of the largest container.



Spill Prevention and Control

Spill Prevention, Control and Counter Measure Plan (SPCC) shall clearly state measures to stop the source of a spill, contain the spill, clean up the spill, dispose of contaminated materials, and train personnel to prevent and control future spills. SPCCs are applicable to construction sites where hazardous wastes are stored or used. Hazardous wastes include pesticides, paints, cleaners, petroleum products, fertilizers, and solvents.

Tips

- **Personal safety is the primary importance.**
- Spills shall be contained and cleaned immediately upon discovery.
- If complete cleanup is not possible immediately, then spills shall be contained until cleanup methods can be employed.
- Store spill kits where potential pollutants are located. Several kits may be needed if there are multiple storage areas. Manufacturer's methods for cleanup and proper disposal must be followed.
- Proper spill and illicit discharge reporting procedures shall be followed for both hazardous and nonhazardous materials.
- Spills shall not be washed down into the storm drain or buried anywhere.

Clean Up Response Procedures

For **non-hazardous materials** such as gasoline, paint, or oil that may be spilled in **small quantities**, the following measures shall be implemented:

- **Personal safety is the primary importance.**
- Use absorbent materials to contain spills and clean the area of residuals.
- Dispose of the absorbent material, soil, and/or rotomill properly.
- Do not hose down spill area with water.

For **non-hazardous materials** that qualify as a **significant spill**, the following measures shall be implemented:

- Contact the Colorado Department of Public Health and Environment (CDPHE) 24-hour Environmental Emergency Spill Reporting Line (1-877-518-5608) within 24 hours of the spill event. A written notification to CDPHE is necessary within 5 days.
- Contact the Colorado State Patrol 24-hour hotline (303-239-4501) if the spill is on a State highway.
- Report spill to project engineer and CDOT maintenance personnel on patrol.
- Call the CDOT illicit discharge hotline (303-512-4426) if spilled material spreads to CDOT storm drain or waterway adjacent to CDOT right-of-way.
- Clean up spills immediately. Use absorbent materials if the spill is on an impermeable surface. Construct a slightly compacted earth dike to contain a spill on dirt areas. If rainfall is present at the time of the spill, cover the spill with a tarp to prevent contaminating runoff.

For spills involving **hazardous materials**, the following measures shall be implemented:

- **Personal safety is the primary importance. Stay upwind and at a safe distance/secure the area from anyone being harmed.**
- Contact the local emergency response team by dialing 911.
- Contact CDPHE 24-hour Environmental Emergency Spill Reporting Line (1-877-518-5608) within 24 hours of the spill event. A written notification to the CDPHE is necessary within 5 days.
- Contact the Colorado State Patrol 24-hour hotline (303-239-4501) if the spill is on a State highway.
- Report spills to the project engineer and/or CDOT maintenance personnel on patrol.

- Call the CDOT illicit discharge hotline (303-512-4426) if spilled material spreads to CDOT storm drain or waterway adjacent to CDOT right-of-way.
- A licensed contractor or a HazMat team shall be used to properly clean up spills immediately.
- Construction personnel shall not try to clean up the spill.



All spills should be cleaned up immediately.



Inspect equipment and vehicles routinely for leaks. Maintain an ample supply of cleanup materials at all designated maintenance areas where leaks and spills are likely to occur.

Stockpile Management

Stockpiles of soil and other erodible materials must be managed so that stormwater does not come in contact with the pile and potentially wash pollutants into state waters including wetlands.

Tips

- Topsoil/embankment stockpiles, where work is temporarily halted, shall be sprayed with soil binder or mulch/mulch tackifier to prevent wind erosion.
- The erodible stockpiles must be contained with a BMP at the toe (or within 20 feet of the toe) at all times.
- Do not place stockpiles in drainage ways or within 50 feet of state waters.



Note that tarps are being used to cover unused materials and materials are on pallets.



There are no temporary perimeter sediment barriers such as erosion logs, silt fence or compacted berms to protect this stockpile from stormwater runoff. Surface treatment on the stockpile may be necessary if left exposed.



Poor placement of stockpiled erosion bales. They are adjacent to a drainageway.

Street Sweeping and Vacuuming

The construction of streets, roads, highways, and parking lots can cause the accumulation of significant amounts of pollutants that can potentially contribute to stormwater pollutant runoff to surface waters. Pollutants, including sediment, debris, and trash can be minimized by street sweeping.

Tips

- Inspect potential sediment tracking locations daily and sweep or vacuum as necessary.
- All sweepings should be disposed of properly.
- Be careful not to sweep up any unknown substance or objects that may be potentially hazardous.
- Do not use kick brooms or sweeper attachments.



Excellent use of a sweeper to clean up a construction site.

Chapter 8 **Special Conditions**

Dewatering Structure..... 8-1
Stream Crossing 8-2

Dewatering Structure

Dewatering structures settle and filter sediment-laden water (see the Sediment Trap BMP in the Sediment Trap and Basin chapter). **Dewatering requires compliance with Sections 107.25.b.7 and 107.25.b.8 on pages 127-129.**

Tips

- Water from dewatering operations shall not be directly discharged into any state waters including wetlands, irrigation ditches, canals, or storm sewers, unless allowed by the permit.
- Discharge into sanitary sewers will not be allowed unless written permission is obtained from the municipality or owner of the sanitary sewer system.
- Dewatering bags must be placed on level ground that has been stabilized with blanket, rock, or another approved BMP.



Poor location of a dewatering bag—it is in a watercourse.

Stream Crossing

A temporary stream crossing is used to provide a way for construction vehicle traffic to cross a watercourse. Temporary access crossings are not intended to be used to maintain traffic for the general public. Section 404 permitting (401 Certification) may be required. **The design of temporary stream crossings must be designed and stamped by a Professional Engineer.**

A bridge or culvert is the best choice for most temporary stream crossings. The materials used to construct most bridges and culverts can be salvaged after they are removed.

Tips

- The temporary waterway crossing shall be placed at right angles to the stream or as directed by Engineer.
- All crossings shall have one traffic lane. The minimum width shall be 12 ft. with a maximum width of 20 ft.
- All temporary crossings shall be removed within 14 calendar days after the structure is no longer needed.

Maintenance

- Inspect weekly and after each significant rainfall. Include assessment of foundations during inspection.
- Periodically remove silt from crossings.
- Replace riprap along inlets and outlets of culverts.



Good application of temporary culvert. Notice riprap approach to culvert



No riprap at approach to prevent sediment from entering the stream.



Good use of temporary bridge.

Chapter 9 Important Numbers

Contact Phone Numbers 9-1
Inspection Top 10..... 9-2

Contact Phone Numbers

CDOT Illicit Discharge Hotline(303) 512-4426

CDPHE Environmental Emergency
Spill Reporting Line(887) 518-5608

Colorado State Patrol
24-hour hotline(303) 239-4501

911 (for emergencies only)

CDOT Water Quality Program - Web Page
<http://www.coloradodot.info/programs/environmental/water-quality>

Inspection Top 10

1. Have routine inspections been performed?
2. Do the SWMP and Erosion Control Plans match current site conditions?
3. Have the BMPs been installed per Standards and/or details?
4. Have the BMPs been properly maintained?
5. Are there signs of sediment leaving the site?
6. Have the sensitive areas been protected?
7. Are stockpiles and hazardous materials properly contained?
8. Is there a Spill Prevention Plan?
9. Are the inactive or completed areas stabilized?
10. Have the corrective actions from previous inspections been addressed?

Final Acceptance Procedures

Reclamation of Washout Areas. After concrete operations are complete, washout areas shall be reclaimed in accordance with subsection 208.05(n) at the Contractor's expense.

Survey. The Contractor shall survey Permanent Water Quality BMPs (Permanent BMPs) on the project after they are constructed and confirm they are at final configuration and grade. The Engineer will identify which Permanent BMPs shall be surveyed prior to the final walk through. The survey shall be performed in accordance with Section 625.

Project Walk Through. Prior to final acceptance, a final walk through of the project shall occur with the Superintendent, the ECS, the Engineer, the Region Water Pollution Control Manager, and CDOT Maintenance personnel; and the CDOT Landscape Architect, CDOT Region Environmental personnel, and the CDOT Hydraulics Engineer as determined by the Engineer in attendance. At this time final stabilization shall be reviewed and BMPs shall be inspected for needed cleaning, maintenance, or removal. Areas will be inspected for any additional BMPs that may be required. Permanent BMPs shown on the plans shall be inspected to confirm that as constructed location, condition, and other plan requirements have been met. Any required work will be listed by the Project Engineer and shall be performed in accordance with subsection 105.21.

Removal of Temporary BMPs. Temporary BMPs subject to removal shall be determined at the final walk through of the project and removed by the Contractor.

Upon completion of work required by walk through, the ECS shall modify the SWMP to provide an accurate depiction of what remains on the project site.

